



manufacturing



specializing in “AIR CONDITIONING, PARTS AND SYSTEMS” for your classic

“PERFECT FIT”

IN-DASH

HEAT/ COOL/ DEFROST

1958-1962 CHEVROLET CORVETTE

CONTROL & OPERATING INSTRUCTIONS

The controls on your new “Perfect Fit” system. Offers complete comfort capabilities in virtually every driving condition. This includes Temperature control in all of the modes. This system also provides the ability to blend the air between Face and Heat / Defrost modes.

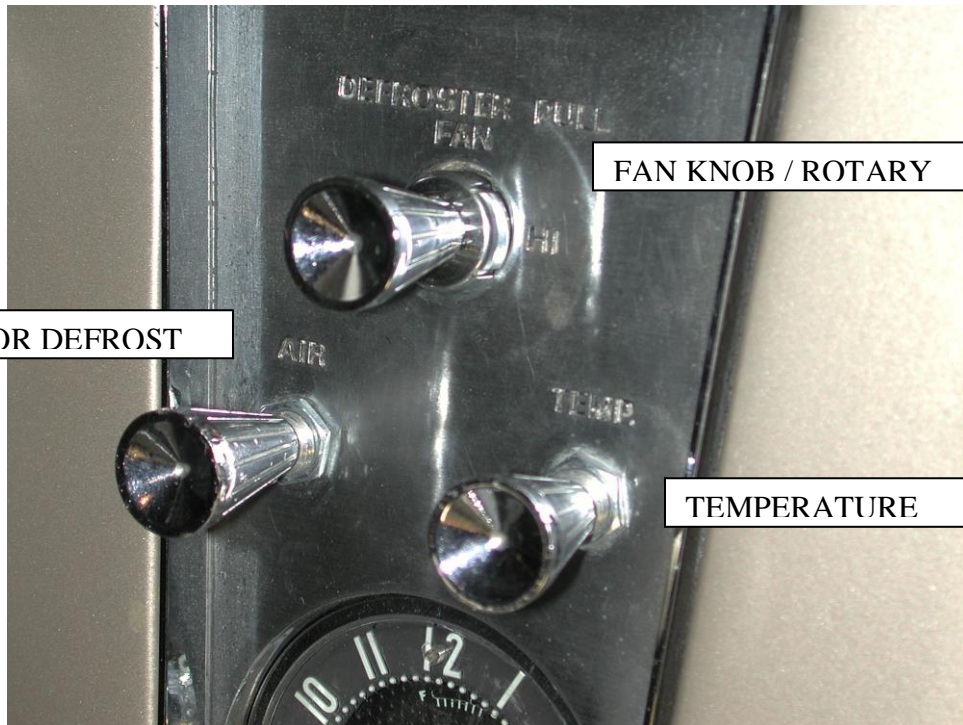

THE PICTURE YOU SEE ON THE FIRST PAGE SHOWS THE CONTROLS IN THE FACE MODE. THIS MEANS THAT THE AIR WILL BE DISTRIBUTED THROUGH THE FACE OUTLETS. THIS ALSO HAS THE TEMPERATURE KNOB IN THE COLD POSITION. WITH THE CONTROLS IN THIS POSITION YOU WILL GET THE AIR THROUGH THE FACE OUTLETS WITH THE COMPRESSOR ON.

CAUTION: ALL OF THE OUTSIDE VENTS MUST BE CLOSED WHEN THE SYSTEM IS IN THE A/C MODE. THIS WILL ALLOW THE A/C SYSTEM TO FUNCTION AT ITS MAXIMUM PERFORMANCE LEVEL.

THE FOLLOWING SUMMARY WILL DESCRIBE EACH OF THE CONTROL LEVERS FUNCTION.

FAN SPEED SWITCH: There are 3 speeds plus Off. When the switch is in the off position it will disconnect the 12V power to the Blower Motor and the A/C Clutch. This will shut down the entire system. When the switch is moved to any of the blower speeds 1, 2 or 3 there is 12V supplied to the Micro-Switch that is mounted on the main housing.

FACE AND FLOOR / DEFROST MODE: When the push pull cable is pulled all the way OUT, it will direct the air to the floor / and defrost ducts. The cable can be moved any position from full in to full out. This will give blend between all distribution outlets.

TEMPERATURE CONTROL: The temperature Knob as shown is in the COLDEST temperature position. As the lever is pulled out the temperature of the discharged air will rise to the HOTTEST point.

Note: The temperature lever will function in any of the modes.

AIR CONDITIONING MODE: The picture shows the Knob in the Face Mode (air-flow out the face outlets).

When the Mode control knob is pushed all the way IN the Air Conditioning is activated and the compressor clutch is on. When the compressor is activated the Temperature Lever will control the air from maximum cold through maximum heat.



specializing in “AIR CONDITIONING, PARTS AND SYSTEMS” for your classic

INSTALLATION INSTRUCTIONS 1958- 62 CHEVROLET CORVETTE

Congratulations!! You have just purchased the highest quality, best performing A/C system ever designed for you Classic Car. To obtain the high level of performance and dependability our systems are known for, pay close attention to the following instructions.

Before beginning the installation check the box for the correct components.

Evaporator
Firewall Block Off
Flex Hose 2”dia. x 1ft (2)
Flex Hose 2”dia. x 2ft (1)
Flex Hose 2”dia. x 3ft (4)
Sack Kit Hardware
Sack Kit Control

IMPORTANT INFORMATION

1. Before starting, read the instructions carefully and follow proper sequence.
2. Check condition of engine mounts. Excessive engine movement can damage hoses to A/C, heater, radiator, transcooler, and power steering systems.
3. Before starting, check vehicle interior electrical functions. i.e. interior lights, radio, horn, etc. When ready to start installation, disconnect battery.
4. Fittings. Use one or two drops of lubricant on O’rings, threads and rear of bump for O’ring where female nut rides. Do not use thread tape or sealants.
5. Always use two wrenches to tighten fittings. Try holding in one hand while squeezing together while other hand holds fitting in position.
6. Shaft seals in a small percentage of compressors will require as much as 3-4 hours run time to become leak free.
7. Compressors supplied in our complete systems are filled with proper amount of oil.
8. Compressor requires technician to hand turn 15-20 revolutions before and after charging with liquid from a charging station before running system. Compressors with damaged reed valves cannot be warranted.
9. Should you have any technical questions, or are suspect of missing, or defective parts, call us immediately. Our knowledgeable staff will be glad to assist you.

YOU CAN NOW BEGIN THE INSTALLATION

DISCONNECT BATTERY GROUND CABLE AND REMOVE BATTERY.

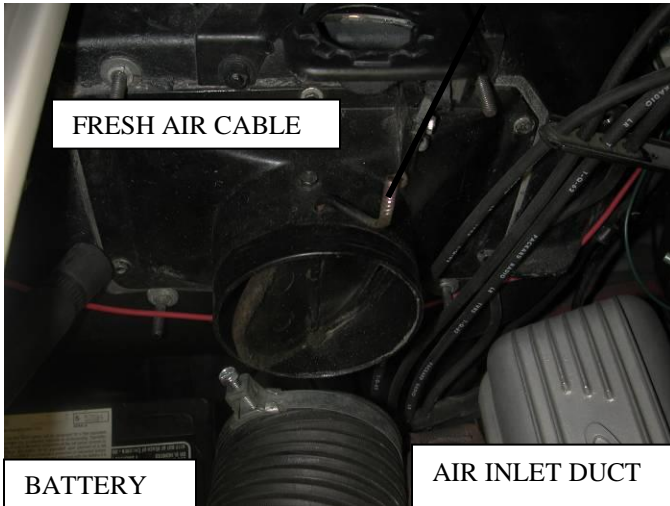

Disconnect battery ground cable.

Disconnect fresh air cable.

Disconnect air inlet duct and remove the duct. Retain duct and all of its original hardware.

CAREFULLY REMOVE THE HOOD FROM THE CAR AND SET ASIDE. DRAIN RADIATOR.

Carefully remove the package tray. Set aside and retain all original hardware.

NOTE: 1958 Models do not have package tray.



Remove trim ring at bottom of the console. Set aside and retain all original hardware.

LOWER TRIM BEZEL



Locate trim bezel around the passenger foot area. Remove screws and the bezel. Set aside and retain all of the original hardware.

Locate the blower switch and cable assembly just above the radio. Pull knob out and using a small screw driver, loosen the set screw in the knob.

Remove and retain the knob and set screw for later reinstallation.

Remove the trim bezel and retain. Remove and discard the blower switch and cable assembly.



Looking behind the console panel.

Locate the Air Cable just below to the right of the blower switch.

Locate the heat/ defrost cable to the left of the Air Cable.

Remove and discard the cable assembly.

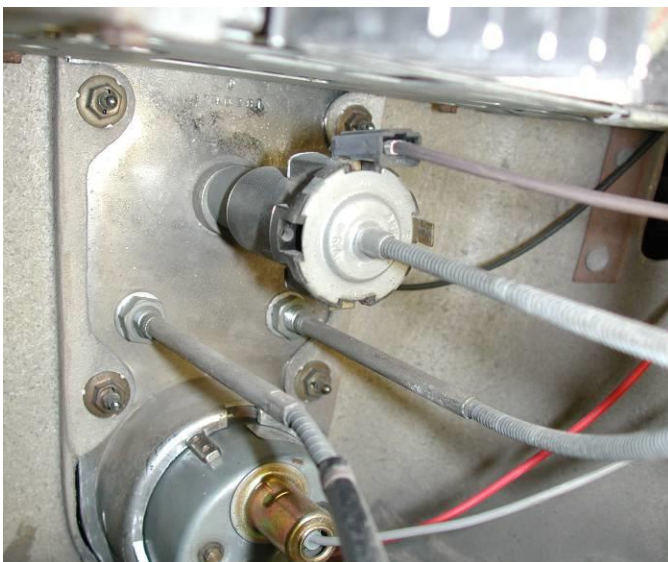

Locate on the end of blower assembly the defrost / heat duct. Remove and discard the original hardware.

Disconnect the heat / defrost cable.

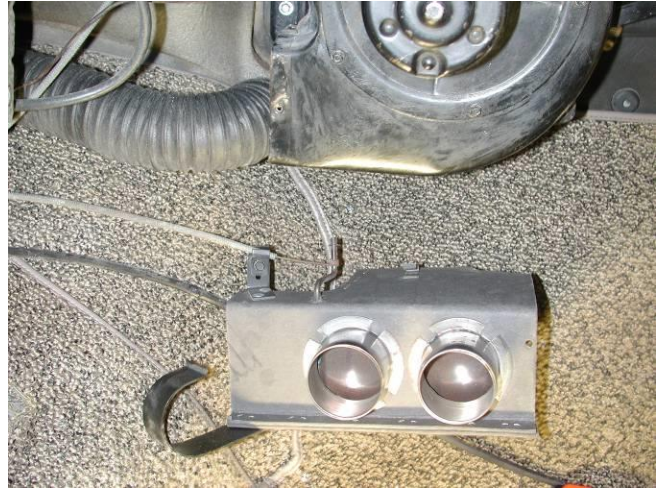

Locate beside heater assembly the return line to the engine.

Disconnect hose clamp from the heater.

Remove hose make sure that you catch the water from the coil.

Remove control cable that is attached to heater water valve located on the side of the heater box.

Locate power wire from the original switch. Cut the connector off. Attach (1) 1/4" male spade connector to the wire.



Located on engine side of firewall is the air inlet and door assembly. Remove (4) nuts around the outside of the housing.

Remove assembly and discard along with original hardware.

Remove heater assembly from behind the glove box.

Discard the heater.

NOTE: KNOBS FOR THE 1958-59 CANNOT BE MODIFIED AND MUST BE PURCHASED SEPARATLY, FROM A CORVETTE PARTS SUPPLIER.

Next few steps would best be completed with the following specific tools in order to complete the modifications correctly.

- 1) 1/8" thru 1/2" step drill.
- 2) 9/64" dia. drill bit.
- 3) 8-32 thread tap.
- 4) 1/4" dia. drill bit.



Locate the original control cable assembly. Carefully cut the knob off of the cable shaft.



Carefully clamp the knob in a vice and drill a hole in the back using a 1/4" diameter drill bit. Drill the hole 7/16" deep.

Next hole will be tapped for a #8-32 set screw. With knob still in the vice, drill a hole 9/64" dia thru to the center.



Locate the #8-32 thread tap and thread the hole.

There are (2) #8-32 set screws provided. Insert into the cable control knobs.

NOTE: THE FOLLOWING STEPS ARE FOR ALL MODEL VEHICLES

The (2) holes below the blower switch hole need to be enlarged. Use a step drill bit and open them up to 7/16" dia.

Locate in the Control Sack Kit the temperature cable assembly.

Slide assembly through hole that is marked TEMP. Attach using the switch nut provided.



Install (1) of the control knobs that was modified to the shaft using the set screw.



Locate the Evaporator and set it on the bench.

Locate (1) 2" dia. x 2ft. flex hose from the kit. Cut to 18".

Attach hose to the defrost outlet on back of the unit using (2) #8 x 3/8" pan head screws.

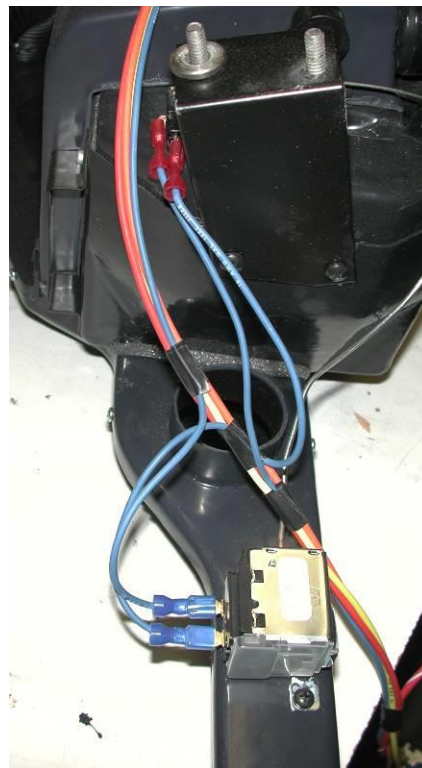
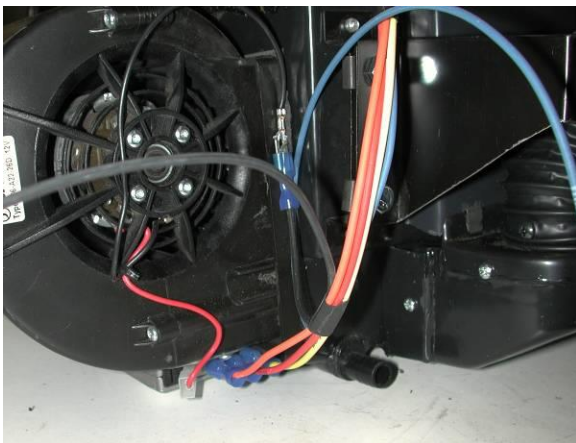

Locate in the control sack kit the wire harness. Attach harness to the resistor and ground wire at the motor. Route harness over top of the unit to the micro switch and thermostat. Connect the wiring per the wiring diagram below.

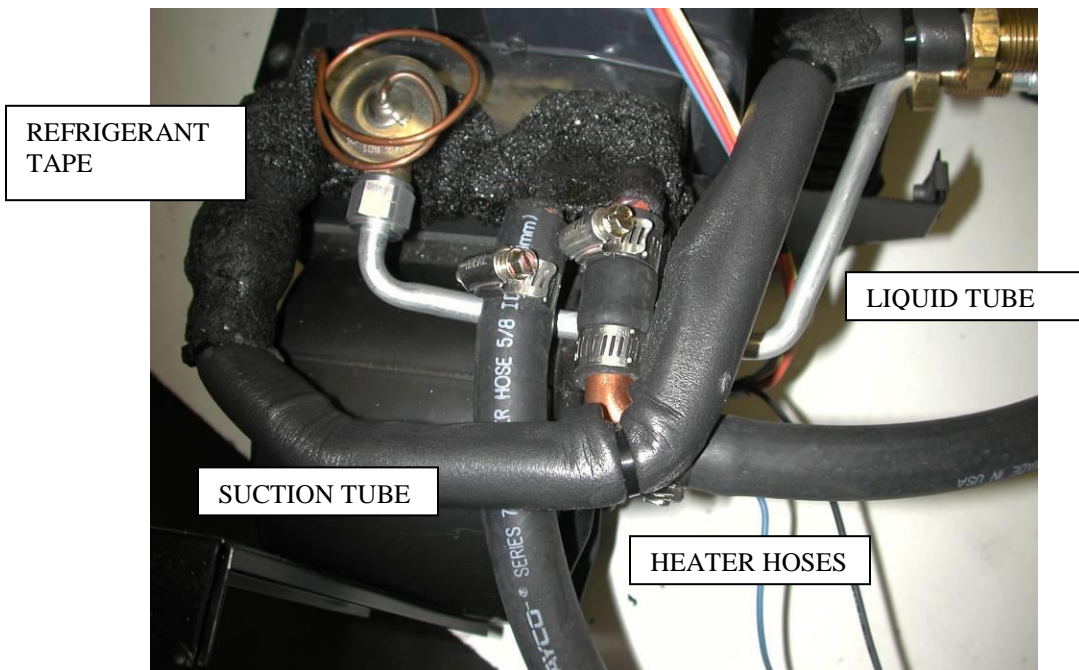
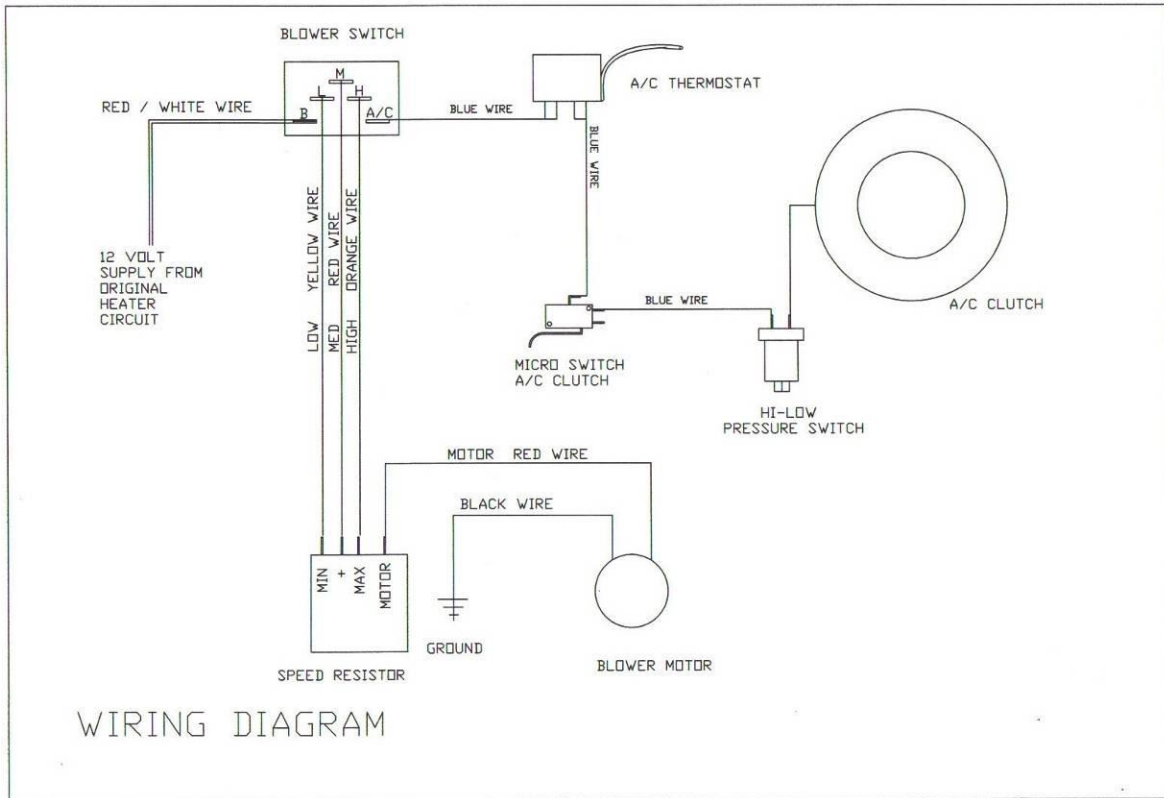

Locate in the hardware sack kit the Suction Tube, Liquid Tube, (1) piece of Heater hose 12" long, (1) piece 18", (2) worm gear clamps, (1) #6, and (1) #10 o-ring.

Attach heater hose to the unit. The 12" hose attaches to 90 deg. Fitting. The 18" hose attaches directly to the evaporator. Use (2) worm gear clamps.

Attach Liquid tube to the expansion valve using (1) #6 o-ring and a few drops of mineral oil.

Attach suction tube to the last fitting using (1) #10 o-ring and a few drops of mineral oil. Using the refrigerant tape provided, cover all exposed metal on the suction tube.



NOTE: The orientation of the refrigerant tubes.

Locate in the hardware sack kit the blower support bracket, and (2) #8 x 3/8" pan head Phillips screws.

Attach bracket to the blower using the screws provided.

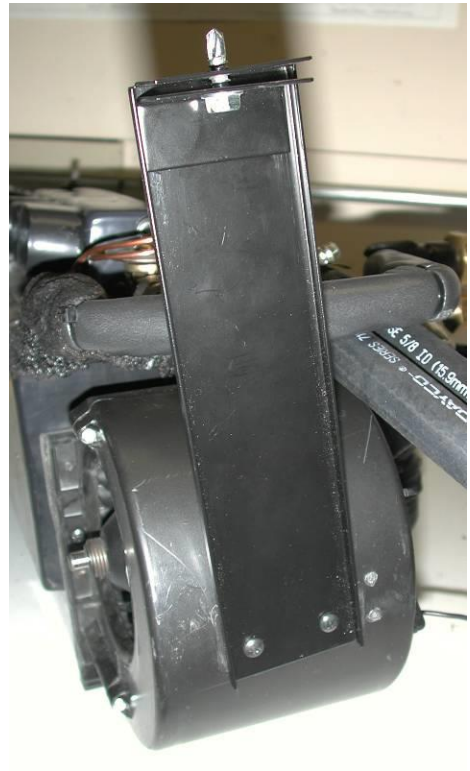



NOTE: 1958-59 Model vehicles remove the hood latch assembly.

Install firewall block off and then reinstall the hood latch assembly using original hardware.

Locate firewall block off plate assembly, lower block off brace, (4) 1/4"-20 x 5/8" hex head screws and (5) 1/4"-20 flange nuts.

Place block off over hole from the engine side.

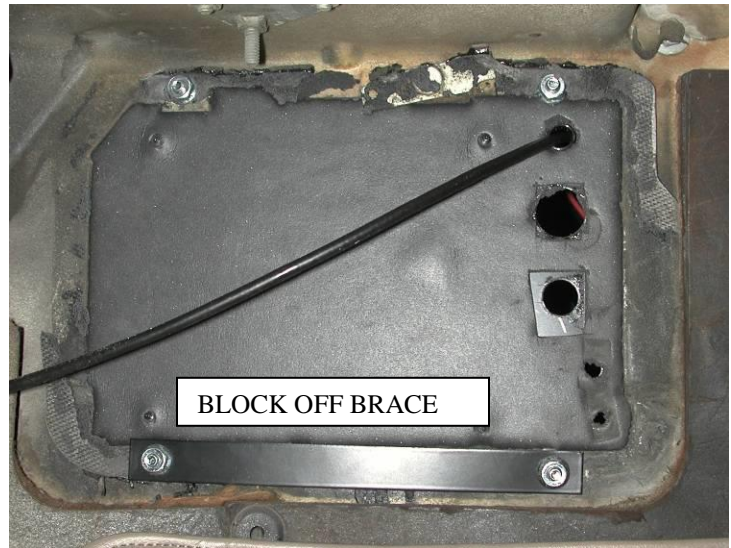

Insert the 1/4" screws through holes in the top and attach using the flange nuts.

Insert the 1/4" screws through block off and then through the block off brace. Attach using the flange nuts.

Install one of the flange nuts to stud on top of the block off.

Route temperature cable through the grommet hole in top of the block off.





Locate and drill (1) 11/16" dia. hole 6" directly below bottom hole in the block off.

Locate remaining control cable assembly and (1) #8 x 3/8" pan head screw.

Attach control cable assembly to the evaporator. Insert offset end of the cable into 3rd hole from the center pivot.



Picture to left shows left mounting bracket for the evaporator.

The screw and nut that supports the instrument panel needs to be removed and discarded.

The grommet that holds the insulation needs to be removed. There will be a hole where the grommet was. Trim insulation back to clear the bracket.



Locate on firewall original hole that the heater valve went through. Enlarge the hole using a 1" drill bit.

Set unit on floor of the vehicle.

Insert heater hose with 90 deg. Elbow through the left hole.

Insert remaining heater hose through the right hole.

Slide unit up into place behind the dash.

Pull heater hoses from engine side as you slide unit into place.

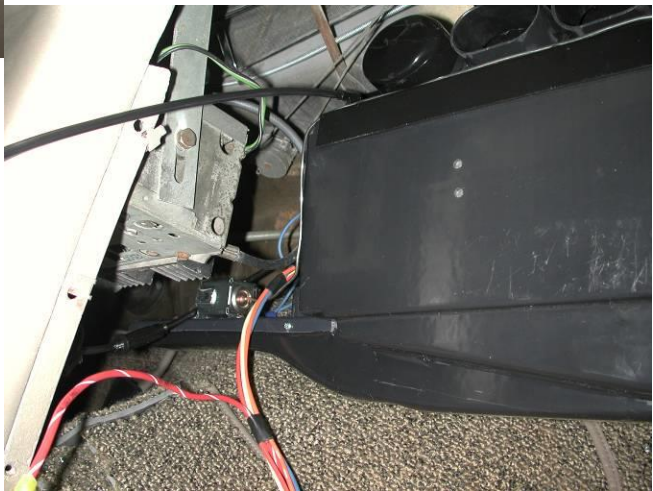

Insert studs through (2) holes next to windshield wiper. Attach using (2) 1/4"-20 flange nuts.

Passenger side bracket clamps to the body just above the unit. Loosely hang the unit.

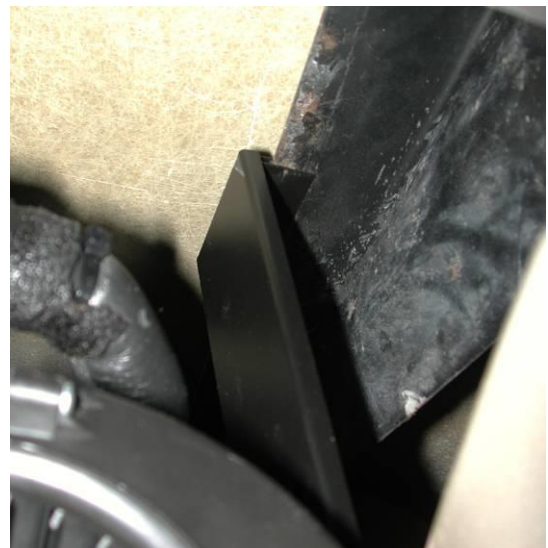



Flex hose from back of the unit needs to be routed over top and attached to the original defrost diffuser using (1) 6" tywrap.

Picture to the right shows the fittings and the rear nuts installed.

Reach up behind the unit and insert fittings through the holes in the block off.

Feed blue clutch wire through same grommet as the control cable.

Attach the rear support bracket using (1) 1/4"-20 x 1" hex screw, through the firewall block off and then into the clip on the bracket.



Now you can tighten the blower support brace. Locate (1) #10 x 3/4" tek screw. Locate black wire from blower motor and ground to the metal brace as shown.

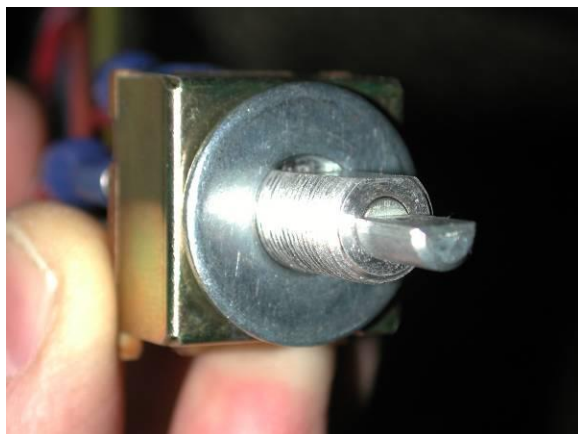

Locate in the control sack kit the large washer, small washer and the switch nut. The blower switch is on end of the wire harness.

Slide the large washer over the shaft.

Holding the switch with the flat on top, insert through original hole in the console.

Slide the small washer over the shaft. Also install the switch nut on to the shaft. Tighten securely.



Route the door cable over and attach through hole marked AIR.

Attach using (1) switch nut.

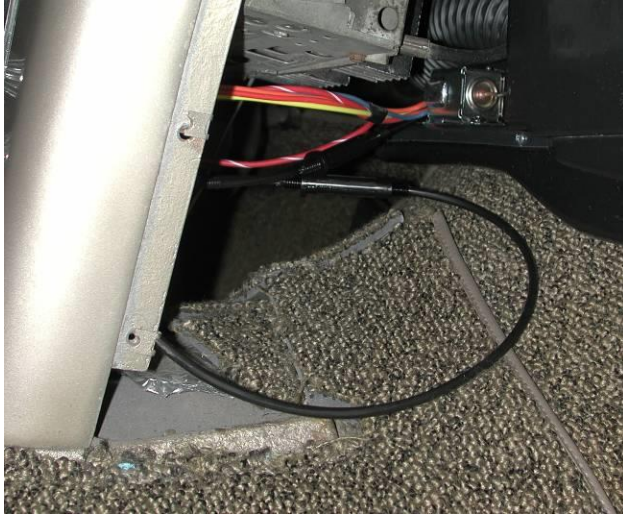

Locate second of the modified knobs and attach to the door cable.

Locate original blower switch knob and nut cover.

Slide nut cover over switch shaft and attach knob with set screw.



Locate (1) 2" x 3ft. flex hose and cut to 30" long.

Attach one end to outlet behind the controls.

Route hose over and up to the drivers defrost diffuser. And attach.

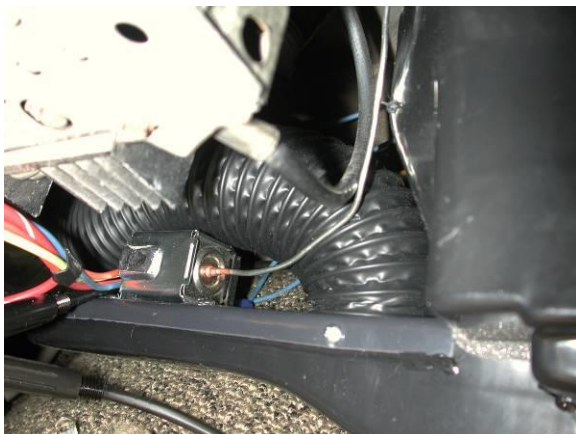

CAUTION: CHECK FOR INTERFERENCE WITH THE WINDSHIELD WIPER CABLES.

Locate 2" flex hose (1) 36" long, and (2) 12" long.

Attach to outlets as shown in the picture below.



Locate in the hardware sack kit (1) louver and (4) u-clips.

Attach drivers louver using (4) u-clips. (2) on each side.

Route flex hose from unit over to the drivers louver.



Reinstall trim bezel using original hardware.

Reinstall trim ring using original hardware.



NOTE: ON 1958-60 MODEL VEHICLES

Trim the louver assembly to 1" as shown.

Locate in the hardware sack kit (2) u-clips.

Attach assembly to the original trim panel using the u-clips.



NOTE: ON 1959-1962 MODEL VEHICLES



Reinstall passenger tray and install the passenger louver.

The (2) screws shown in picture will insert through brackets that are attached to the passenger louver assembly.

Locate flex hose from the unit and attach to rear of the louver assembly.



Locate clear drain tube from the hardware sack kit and attach it to drain fitting on the unit and out through the hole previously drilled.

CAUTION: The control cables are equipped with inline adjusters. Adjust the Defrost, Heat / Face door, and Water valve cable so that full travel of the Control cable operates the door to its full travel. Make sure that the water valve completely closes when cable is in the cold position.

The engine compartment components should be installed at this time. Carefully follow the electrical diagram provided on page 7

NOTE: 1961-62 MODELS ONLY

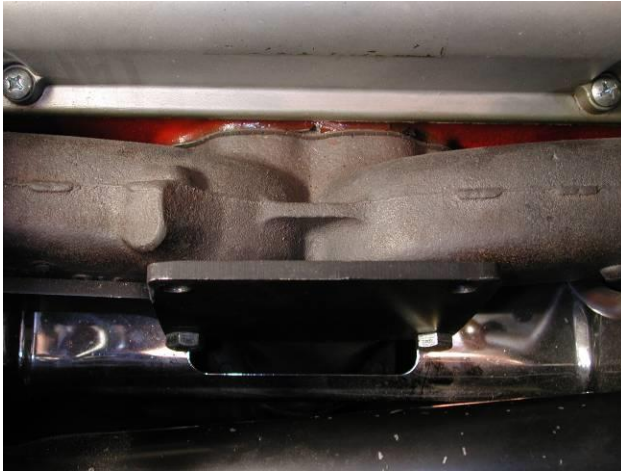

Locate the overflow tank relocation bracket, (2) 3/8"-16 x 3 3/4" long hex head bolts, (1) 3/4 X 13/32" X 1/2" long spacer, (2) 5/16"-18 x 3/4" , and 5/16" nuts.

Install bracket over compressor mount on the exhaust manifold. The other hole requires a 3/8"-16 x 3 3/4" and (1) 1/2" spacer.

Remove the manifold bolt just behind the compressor mount. Install new bolt with 1/2" spacer. Tighten securely.

Attach overflow tank bracket to the relocation bracket using (2) 5/16-18 bolts and nuts.



Locate upper support brace from the condenser kit. Remove the manifold bolt and attach the brace as shown.

Reinstall overflow tank and clamp the end under the mounting strap.

Locate following components from the condenser kit. Condenser, (2) bottom condenser mounting brackets, (2) top mounting brackets, and (8) #10 x 3/8" hex head screws.

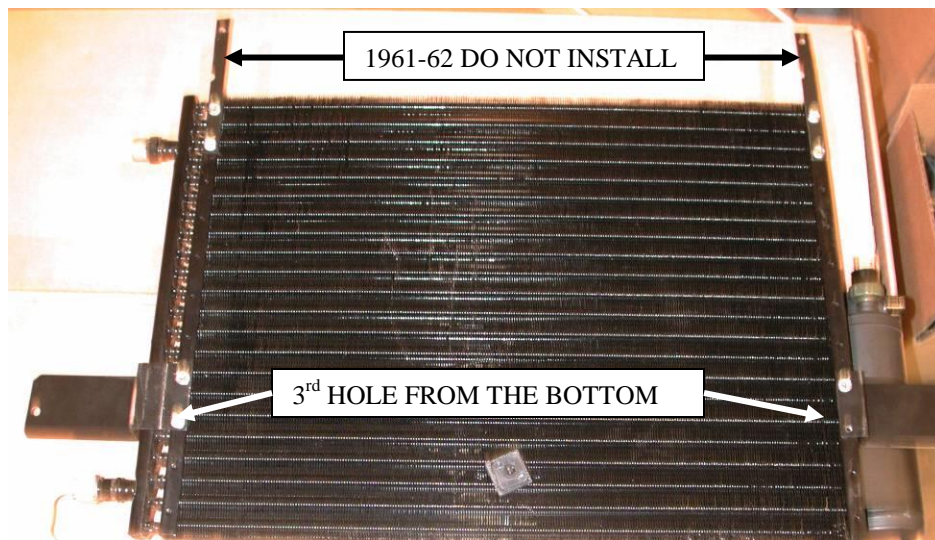

Install the condenser brackets as shown above.

Locate following items from the condenser kit. Receiver drier, receiver drier bracket, pressure switch and electrical boot.

IF

Also locat

(2) 9" electric fans, (4) fan mounting brackets, (1) center mounting bracket, (1) push through fan support ty-down (2 pads), (5) #10 x 3/8" hex head screws, and (8) 1/4"-20 x 5/8" hex screws and flange nuts. Also locate in the control sack kit the relay and fan switching harness.

Attach to condenser the drier and drier mounting bracket using 2nd hole from bottom of the condenser as shown. Attach using (2) # 10 x 3/8" hex screws. Note location of the drier on the bracket should be all the way up.

Attach pressure switch to top of the drier using a few drops of mineral oil.

IF YOU PURCHASED THE ADDITIONAL DUAL FAN UPGRADE KIT

Locate the (2) 9" electric fans, (4) fan mounting brackets, (1) center mounting bracket, (1) push through fan support ty-down (2 pads), (5) #10 x 3/8" hex head screws, and (8) 1/4"-20 x 5/8" hex screws and flange nuts. Also locate in the control sack kit the relay and fan switching harness.

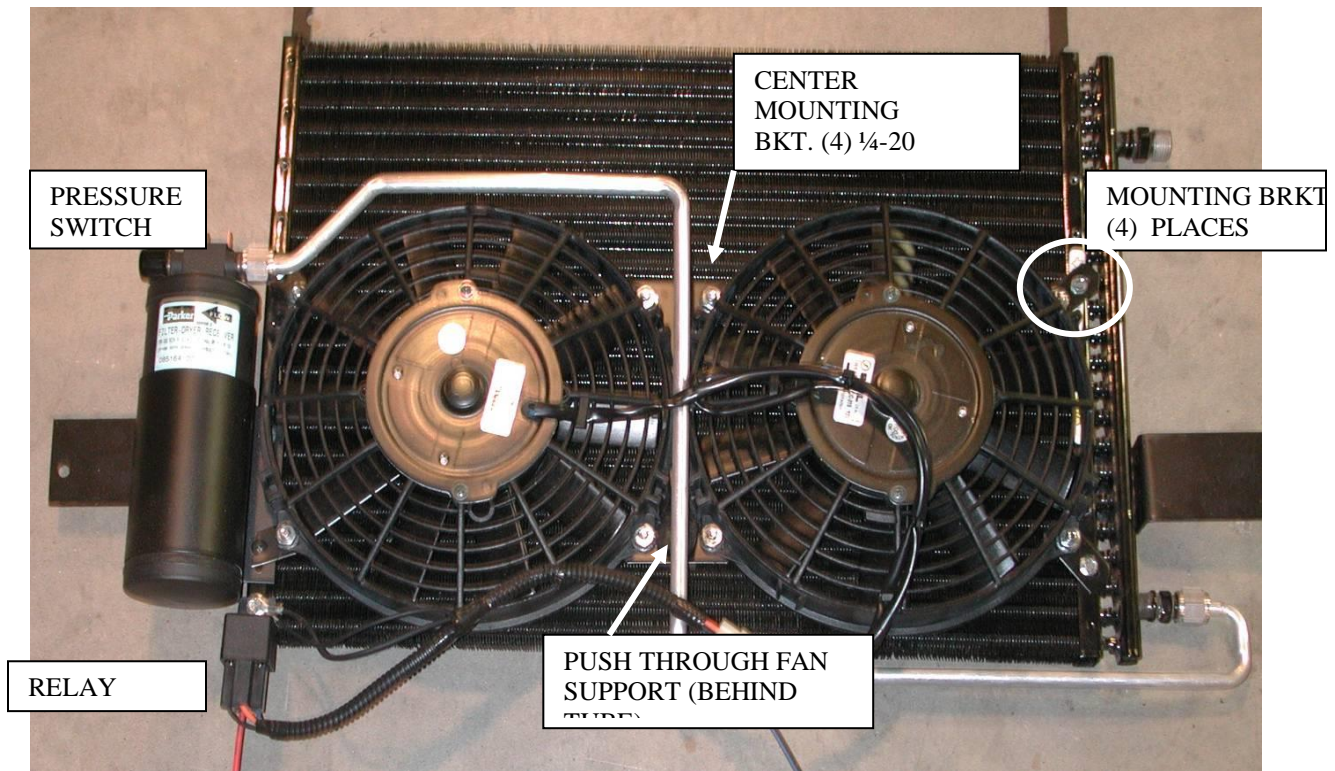

Attach fans and there mounting brackets to the condenser. Using hardware as shown on pg-19. Remove the bottom drier bracket screw and reinstall with bottom left fan mounting bracket.

Locate the condenser liquid tube (condenser to drier) and (2) #6 o-rings. Attach tube to assembly using (2) #6 o-rings and a few drops of mineral oil.

Locate Fan Relay Harness, and (2) #10 x $\frac{3}{4}$ " tek screw.

Attach relay to the condenser using (1) #10 screw. Connect wiring using the wiring diagram on page 20.

Ground black wire on relay assembly to steel on the vehicle.

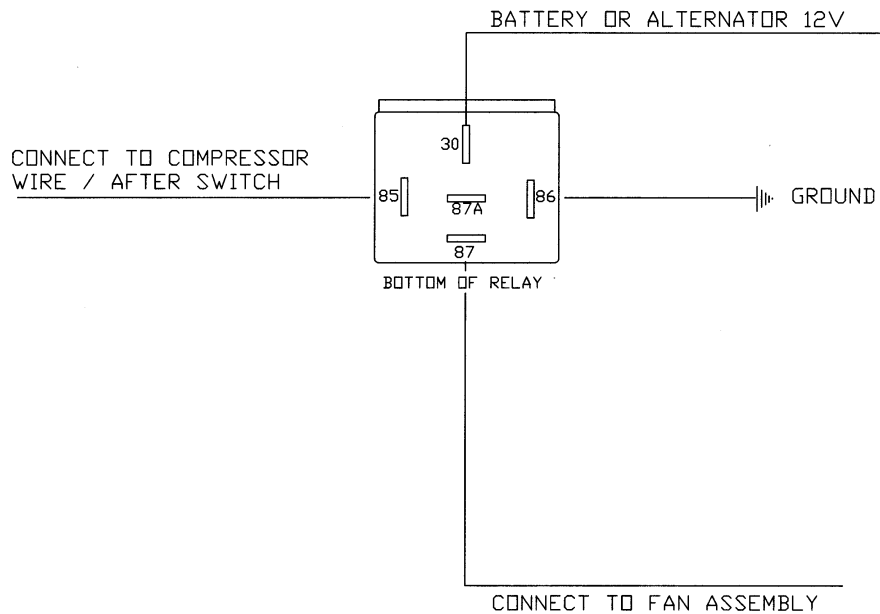

AUXILARY FAN RELAY / ELECTRICALS

1960-62 Vehicles

Grille needs to be removed in order to locate and drill for the lower condenser mounting brackets. Carefully remove grille retain original hardware.

1958-59 Vehicles

The grilles can be removed using following method.

Picture to the right shows back side of the grille. Remove center bracket and retain the hardware. This is typical of both sides of the grille.



Remove cross brace from the grille on both sides and retain hardware.

Remove grille and set aside.

1958-60 Vehicles

Locate the discharge tube and (1) #8 o-ring.

Slide the condenser into position. Attach tube to condenser. And insert tube through the original wire harness hole.

Locate condenser horizontally using the tube as a locator. Then carefully drill (2) 1/8" holes in the upper radiator cross brace. Install (2) #10 x 3/8" pan head screw.

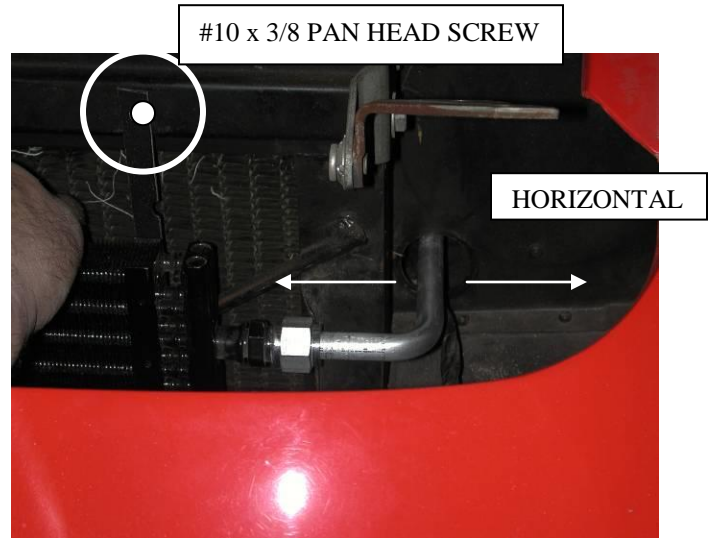

With condenser in place drill (2) holes on drivers and passengers side brackets through the bulkhead.

Attach brackets using (2) 1/4"-20 x 5/8" hex head screws and flange nuts provided.

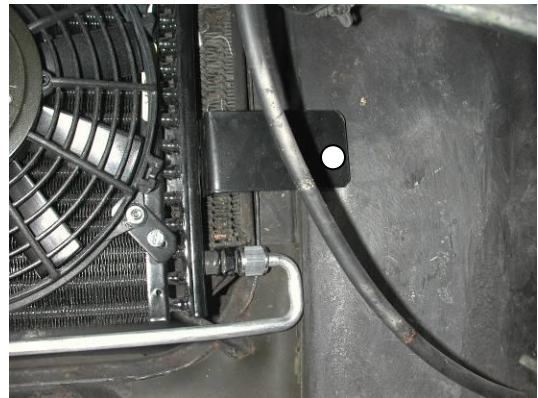

Reinstall grill assembly using original hardware.

1961-62 Vehicles

Attach upper condenser bracket to the radiator mounting studs.

Slide radiator into the cradle.

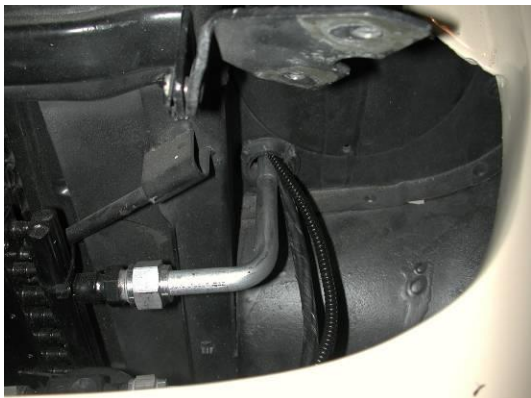
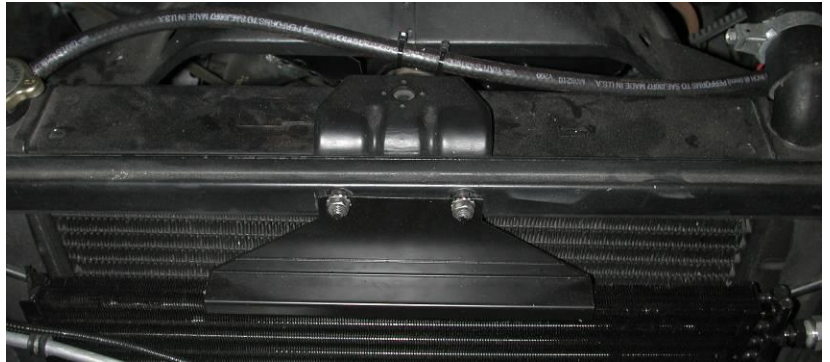

Locate the #8 discharge tube. Loosely attach to the condenser and insert through grommet hole as shown. This will locate the assembly from side to side.

Locate and drill $\frac{1}{4}$ " dia holes through the condenser brackets. As shown on the previous page.

Remove condenser assembly from the car. Reinstall grille using the original hardware. Slide condenser assembly back into place and install the upper radiator brackets to the original studs. Attach lower brackets using $\frac{1}{4}$ "-20 x $\frac{5}{8}$ " hex screws and flange nuts.

Install discharge tube to the condenser using (1) #8 o-ring and a few drops of mineral oil.

ALL VEHICLES



Locate the liquid line and (1) #6 o-ring.

Hold line from the drier and locate the hole center and drill (1) $\frac{11}{16}$ " diameter hole for the bulkhead fitting. Also drill (1) $\frac{1}{2}$ " dia hole just above fitting. Locate and insert the plastic grommet supplied.

Install tube to drier using (1) #6 o-ring and a few drops of mineral oil. The bulkhead end through the hole previously drilled.

It is recommended that the heater hoses be replaced at this time. Hookup heater hoses to the connections coming through the firewall.

Locate in the Hardware Sack Kit the Water Valve and (3) worm gear clamps.

Attach hose on outboard side to supply line from the engine.

Cut off the return heater hose and attach to water valve and then to hose from the evaporator. Use the worm gear clamps supplied.



Locate Temperature Control Cable and attach it to the water valve as shown. Set cable so that the Temp knob is pushed all the way in and the water valve is in its fully closed position.



Locate the Liquid Hose.

Attach Liquid hose to bulkhead tube and route along fender well to fitting on the firewall.

Attach using (2) o-rings and a few drops of mineral oil.



Locate the discharge hose.

Attach hose to fitting on the drivers side bulkhead.

Using (1) #8 o-ring and a few drops of mineral oil.



Route discharge hose along fender well and attach end with service port to rear of the compressor, using (1) #8 o-ring and a few drops of mineral oil.



Locate the suction tube, (2) #10 o-rings, (1) #8 hose clamp, and (1) #10 x 3/4" tek screw.

Route suction tube from #10 fitting on firewall across and along edge of the hood opening to drivers side of the vehicle. Attach to the firewall using hose clamp and screw.

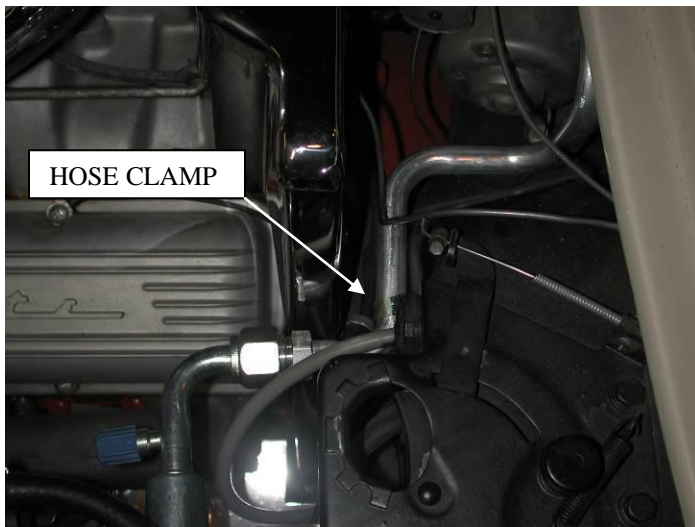

Locate suction hose and attach end with service port to rear of the compressor and back to the suction tube using (2) #10 o-rings and a few drops of mineral oil.

Route clutch wire from firewall block off to pressure switch on drier and along the liquid hose, out through grommet above the bulkhead fitting. Attach to one of the white wires on the pressure switch.

The second white wire on pressure switch goes to compressor clutch and the fan relay harness. Refer to wiring diagram for proper connections.

The fan ground needs to be attached with it's own screw.

***THE ENGINE COMPARTMENT OF YOUR SYSTEM IS COMPLETE.
THE UNIT IS READY FOR EVACUATION AND CHARGING.
THIS SHOULD BE DONE BY A QUALIFIED AND CERTIFIED AIR
CONDITIONING TECHNICIAN.***

***NOTE: COMPRESSOR IS SUPPLIED WITH THE
CORRECT OIL CHARGE. DO NOT ADD OIL TO SYSTEM.***

***134a SYSTEMS 24 oz OF REFRIGERANT
Recommend that power fuse is 25amp minimum***

***Congratulations you have completed the install of your
CLASSIC AUTO AIR "Perfect Fit Series" system.***

IMPORTANT

**CAUTION: WATER VALVE MUST BE INSTALLED PER
THE INSTRUCTIONS.**

Classic Auto Air has done extensive testing on the correct method to install the water valve in order to get a repeatable and progressive temperature control.

Locate the **bottom** connection from the evaporator/heater unit off of the firewall and attach a 6" piece of 5/8" dia. heater hose with the supplied hose clamp. Next attach the inlet side of the water valve using another supplied hose clamp, (make sure the arrow on the water valve points toward the engine) Attach a heater hose from the outlet side of the water valve and route to the connection on the water pump.

NOTE: WATER VALVE = WATER PUMP

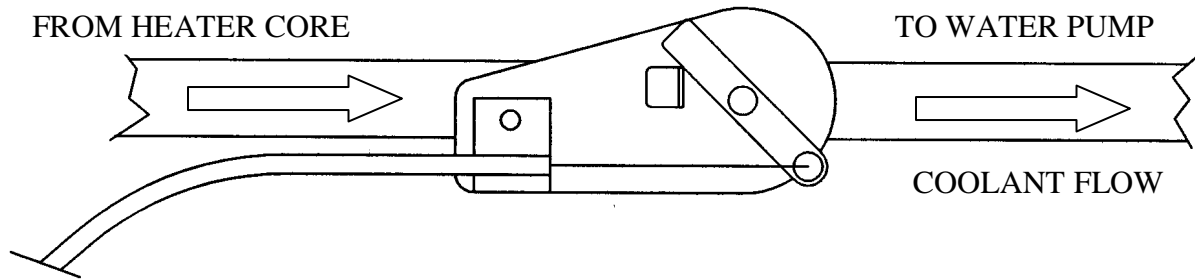

CAUTION: WATER VALVE MUST BE INSTALLED ON HEATER LINE ROUTED TO WATER PUMP.

NOTE: COMPRESSOR PURCHASED WITH KIT IS SUPPLIED WITH THE CORRECT OIL CHARGE. DO NOT ADD OIL TO SYSTEM.

***134A SYSTEMS 24 oz OF REFRIGERANT
Recommend that power fuse is 25amp minimum***