

3000 SERIES STEPGUARD

GRILLE GUARD ASSEMBLY INSTRUCTIONS

PART NO. 3324B & 3324C 08-09 FORD E-SERIES 2/4WD

Do not attempt to install this product on any vehicle other than the one it is designed for and listed above!

PARTS LIST

<u>QTY</u>	<u>PART DESCRIPTION</u>	<u>QTY</u>	<u>PART DESCRIPTION</u>
10	3/8" X 1 1/4" HEX BOLT	2	3324 SIDE PLATE
10	3/8" LOCK WASHER	1	ST3293 3" X 38 1/4" BOTTOM STEP TUBE
4	3/8" HEX NUT	1	CP3293 38 1/4" CENTER PLATE
4	3/8" FLAT WASHER	1	TT3293 2" X 38 1/4" TOP TUBE

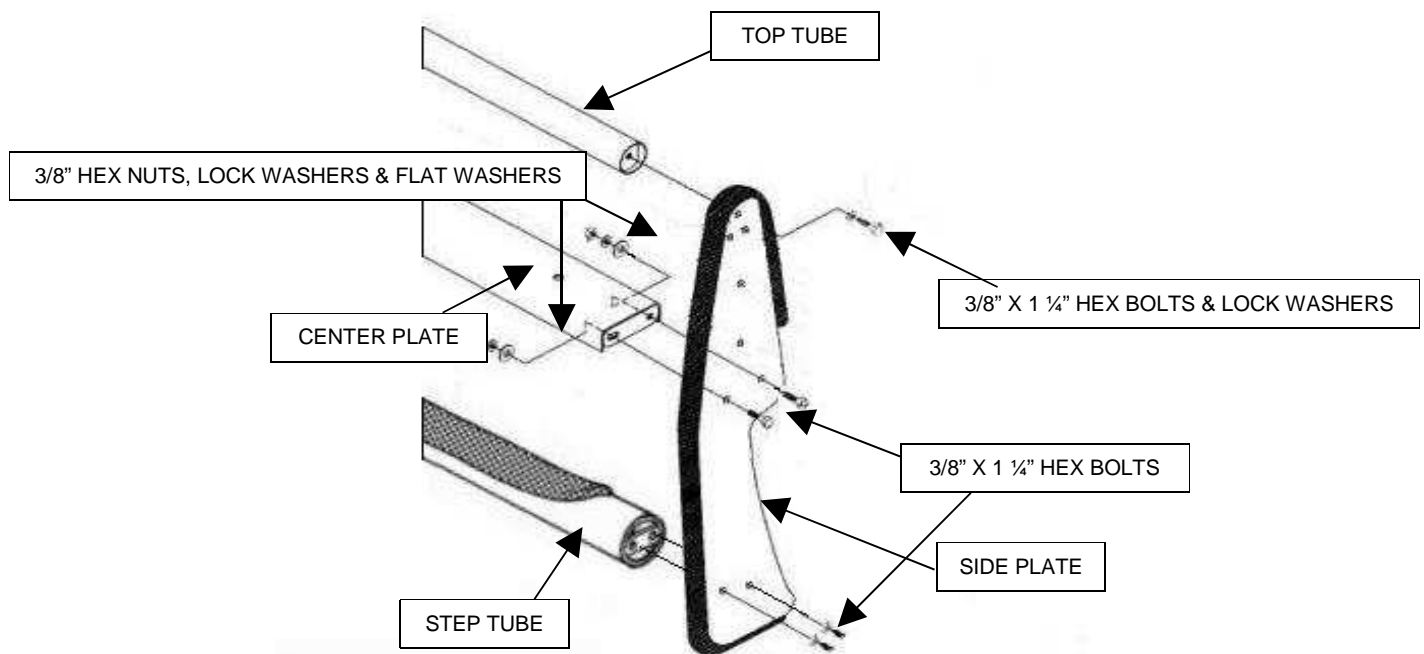

ASSEMBLY INSTRUCTIONS

READ THE ASSEMBLY AND INSTALLATION INSTRUCTIONS COMPLETELY BEFORE YOU BEGIN.

STEP 1. BEGIN THE GRILLE GUARD ASSEMBLY BY LAYING THE COMPONENTS OUT ON A PROTECTIVE SURFACE.

STEP 2. POSITION THE GRILLE GUARD SIDE PLATES WITH THE FRONT EDGE DOWN AND THE TOP AND BOTTOM STEP TUBE BETWEEN THE SIDE PLATES.

STEP 3. ATTACH THE TOP AND BOTTOM STEP TUBE TO THE SIDE PLATES USING THE 3/8" X 1 1/4" HEX BOLTS AND LOCK WASHERS. DO NOT TIGHTEN.

STEP 4. POSITION THE CENTER PLATE BETWEEN THE GRILLE GUARD SIDE PLATES, WITH THE **SLOTTED MOUNTING HOLES** IN THE CENTER PLATE DOWN.

STEP 5. INSERT THE 3/8" X 1 1/4" HEX BOLTS THROUGH THE HOLES IN THE SIDE PLATES AND CENTER PLATE, AND INSTALL THE 3/8" FLAT WASHERS, LOCK WASHER AND HEX NUTS. DO NOT TIGHTEN.

STEP 6. ALIGN THE GRILLE GUARD, AND TIGHTEN ALL NUTS AND BOLTS.

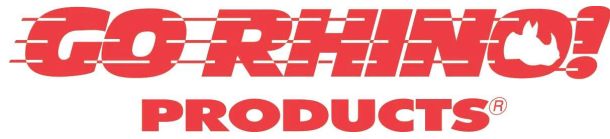

3000 SERIES STEPGUARD

COMPLETE GRILLE & BRUSH GUARD INSTALLATION INSTRUCTIONS

PART NO. 3324B & 3324C 08-09 FORD E-SERIES 2/4WD

Do not attempt to install this product on any vehicle other than the one it is designed for and listed above!

PACKING LIST

<u>QTY</u>	<u>PART DESCRIPTION</u>	<u>QTY</u>	<u>PART DESCRIPTION</u>
2	1/4" X 3/4" HEX BOLTS	4	1/2" X 1 1/2" HEX BOLTS
2	1/4" FLAT WASHERS	4	1/2" FLAT WASHERS
2	1/4" NYLON LOCK NUTS	4	1/2" LOCK WASHERS
4	8M-1.25 X 30M HEX BOLTS	4	1/2" HEX NUTS
4	5/16" LOCK WASHERS	1	32411 DRIVER LOWER BRACKET
4	5/16" FLAT WASHERS	1	32412 PASSENGER LOWER BRACKET
4	3/8" X 1 1/4" HEX BOLTS	1	32431 DRIVER AUXILIARY BRACKET
4	3/8" FLAT WASHERS	1	32432 PASSENGER AUXILIARY BRACKET
4	3/8" LOCK WASHERS	1	32421 DRIVER UPPER BRACKET
4	3/8" HEX NUTS	1	32422 PASSENGER UPPER BRACKET
		1	32442 LICENSE PLATE BRACKET

INSTALLATION INSTRUCTIONS

READ THE ASSEMBLY AND INSTALLATION INSTRUCTIONS COMPLETELY BEFORE YOU BEGIN.

REMOVE THE LICENSE PLATE AND PLASTIC MOUNTING BRACKET FROM THE FRONT BUMPER.

STEP 1. BEGINNING WITH THE DRIVER SIDE, LOCATE AND REMOVE THE LOWER BUMPER BOLT AND THE HEX NUT SECURING THE BUMPER BRACKET TO THE FRAME RAIL. **PHOTO #1**

STEP 2. POSITION THE DRIVER SIDE LOWER BRACKET OVER THE BUMPER BRACKET BOLT AND RE-INSTALL THE FACTORY NUT. DO NOT TIGHTEN. ATTACH THE DRIVER SIDE AUXILIARY BRACKET TO THE BUMPER BRACKET USING (1) 8M HEX BOLT, 5/16" LOCK WASHER AND FLAT WASHER, AND TO THE LOWER BRACKET USING (1) 3/8" X 1 1/4" HEX BOLT, FLAT WASHERS LOCK WASHER AND HEX NUT. DO NOT TIGHTEN. **PHOTO #2**

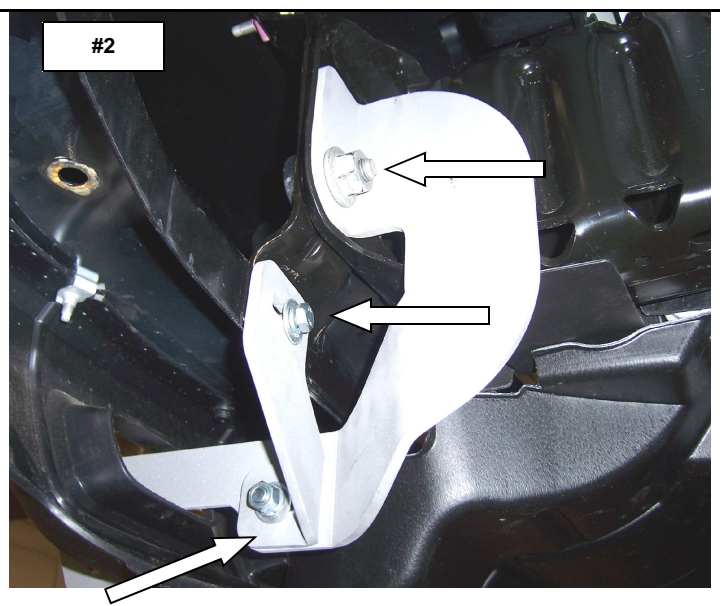
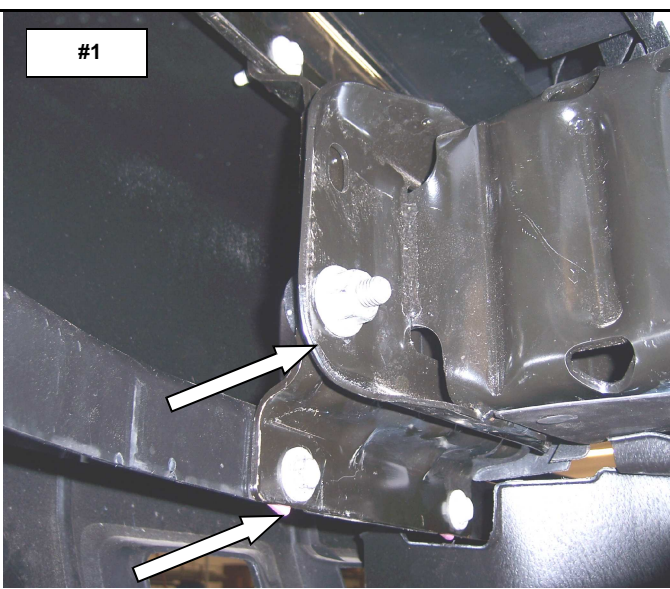

STEP 3. LOCATE AND REMOVE THE UPPER BUMPER BOLT. **PHOTO #3**

STEP 4. FROM BEHIND THE BUMPER, INSERT THE UPPER BRACKET THROUGH THE OPENING BETWEEN THE GRILLE AND BUMPER. **PHOTO #4**

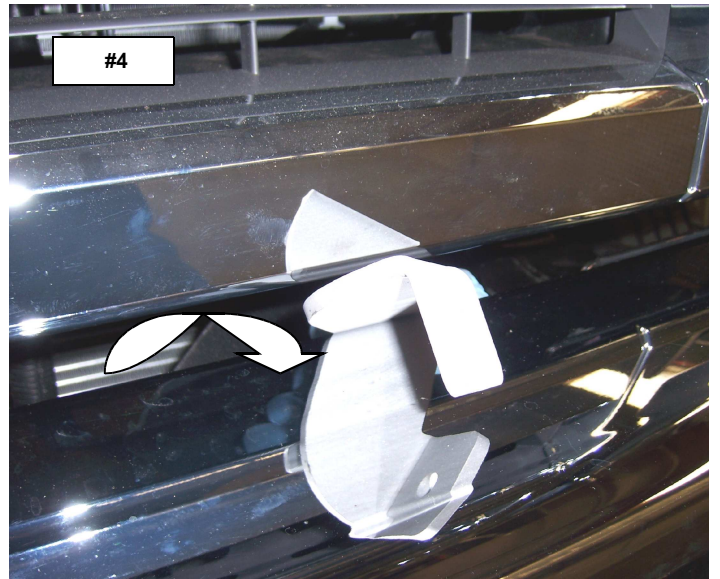
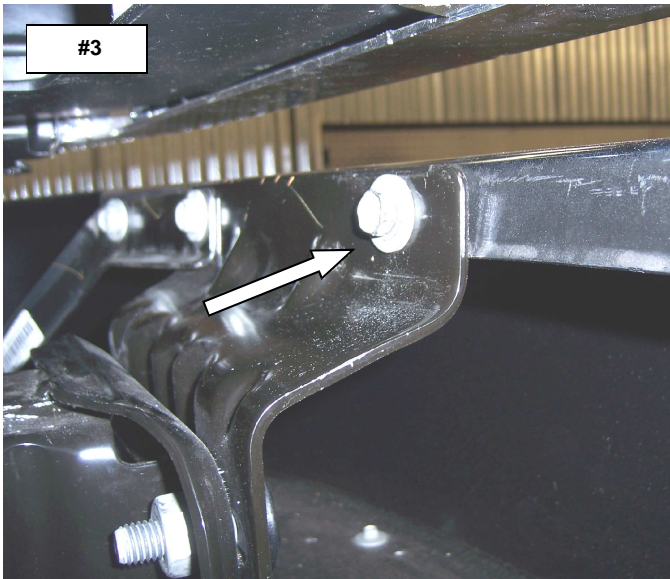

STEP 5. ATTACH THE UPPER BRACKET TO THE BUMPER BRACKET USING (1) 8M HEX BOLT, LOCK WASHER AND FLAT WASHER. DO NOT TIGHTEN **FIG #5**

REPEAT THE ABOVE PROCEDURE TO INSTALL THE PASSENGER SIDE BRACKETS.

STEP 6. ATTACH THE GRILLE GUARD ASSEMBLY TO THE LOWER BRACKETS USING (4) 1/2" X 1 1/2" HEX BOLTS, FLAT WASHERS, LOCK WASHERS AND HEX NUTS. DO NOT TIGHTEN. **PHOTO #6**

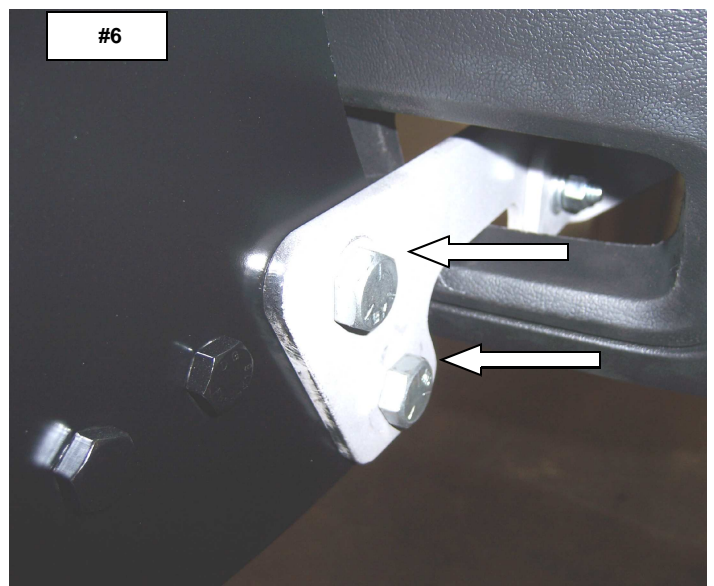
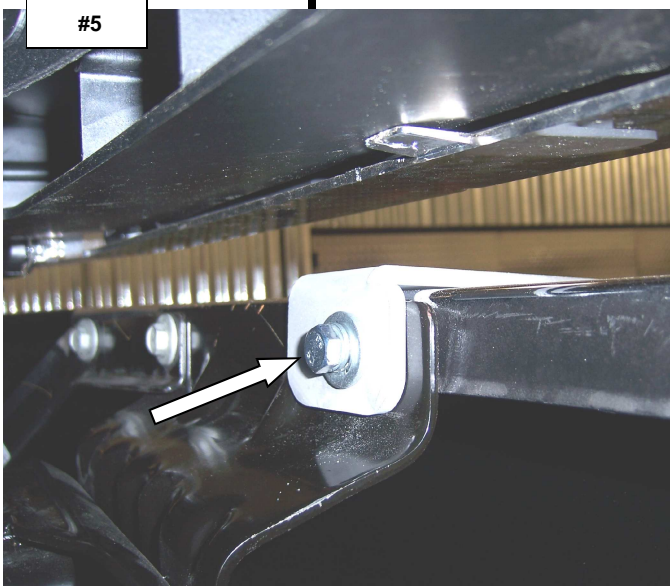

STEP 7. ATTACH THE GRILLE GUARD ASSEMBLY TO THE UPPER BRACKETS USING (2) 3/8" X 1 1/4" HEX BOLTS, FLAT WASHERS, LOCK WASHERS AND HEX NUTS. **PHOTO #7**

STEP 8. ALIGN THE GRILLE GUARD ASSEMBLY WITH THE FRONT OF THE VEHICLE AND TIGHTEN ALL NUTS AND BOLTS. **PHOTO #8**

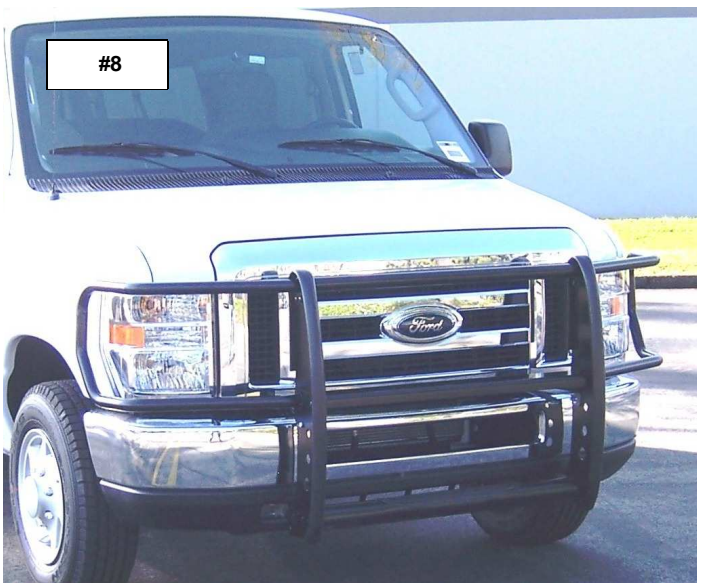
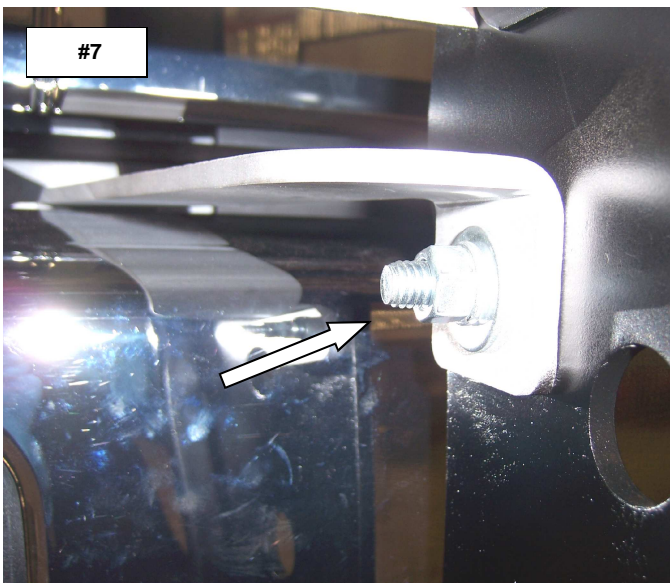

IF YOU'RE STATE LAW REQUIRES A FRONT LICENSE PLATE, LOCATE AND REMOVE THE VALANCE BOLT AND ATTACH THE SUPPLIED LICENSE PLATE BRACKET TO THE INSIDE OF THE BUMPER USING THE FACTORY BOLT. **PHOTO #1 & 2**

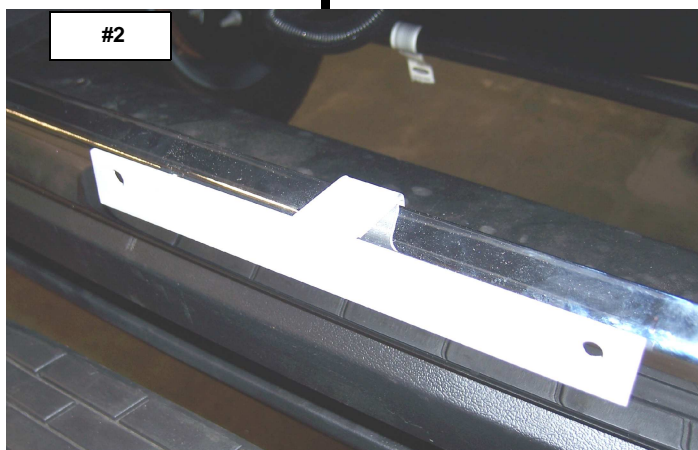
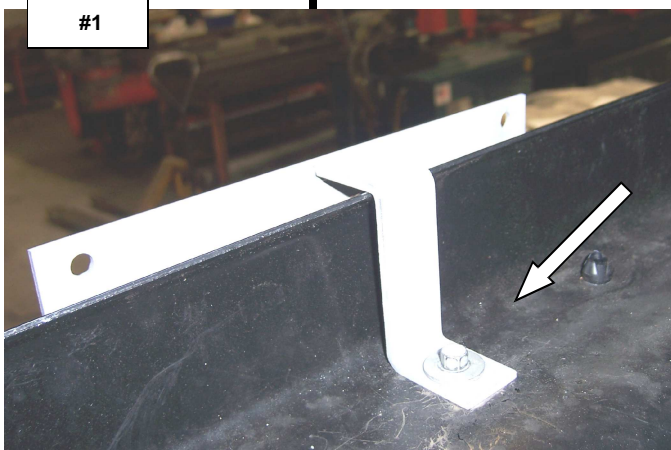

ATTACH THE BOTTOM OF THE LICENSE PLATE TO THE BRACKET USING (2) 1/4" X 3/4" HEX BOLTS, FLAT WASHERS AND LOCK NUTS. **PHOTO #3**



**FOR TECHNICAL OR WARRANTY INFORMATION CALL:
TOLL FREE (888)427-4466 FAX (714)672-0278
GO RHINO! Products® 591 W. Apollo St. Brea, CA 92821**