



## Kit Parts List

<u>DESCRIPTION</u>	<u>QTY.</u>	<u>DESCRIPTION</u>	<u>QTY.</u>
Nitrous Solenoid	1	.043 N20/ Fuel Jet	1
Fuel Solenoid	1	.052 N20/ Fuel Jet	1
24" -4AN Hose, 3 AN nut, 1/8 NPT end	2	.064 N20/ Fuel Jet	1
3' Hose, -4AN, purple	1	.074 N20/ Fuel Jet	1
16' Hose, -4AN, purple	1	.088 N20/ Fuel Jet	1
Nitrous Nozzle	1	Arming Switch	1
¼ NPT to -4 AN Filter Fitting	2	Switch Cover	1
-4 AN to 1/8 NPT Fitting	1	Electronic Throttle Activation TPS Switch	1
-4 AN to 1/16 NPT Fitting	1	Red 18 GA. Wire	15ft.
90 deg., -4 AN Swivel Adaptor	1	Red 14 GA. Wire	15ft.
1/8 NPT Bulkhead Fitting w/Nut	1	30amp Fuse Holder	1
10lb. Nitrous Bottle w/Valve	1	30amp Fuse	1
Bottle Bracket (short)	1	Bosch 20amp Mini Relay	1
Bottle Bracket (long)	1	5/16-18 X 1" Bolt for Bottle Brackets	4
Solenoid Bracket	2	5/16 - 18 Nut for Bottle Brackets	4
.026 N20/Fuel Jet	1	5/16 Flat Washer	4
.030 N20/ Fuel Jet	1	Solenoid Bracket Screws	4
.034 N20/ Fuel Jet	1	1/8-27 NPT Tap	1
.036 N20/ Fuel Jet	1	Schrader Valve Removal Tool	1
.038 N20/ Fuel Jet	1		

### Why our nitrous system is better

- A complete nitrous system. Everything is included in this kit for an easy, professional installation.
- Adjustable from 100-250 horsepower. Maximum horsepower for all-out racing use.
- The ZEX™ Race EFI Nitrous System is activated at wide open throttle with advanced electronics that monitor your throttle position sensor (TPS). Easy and safe activation, especially with throttle-by-wire systems.
- Unique nozzle design has “Active Fuel Control” built in. This feature monitors bottle pressure and when the nitrous system is engaged, it adds or subtracts enrichment fuel so the engine never runs too rich or too lean.

### Quick Start Reference Guide

**How the ZEX™ Race EFI Nitrous System works:** The ZEX™ 82037 nitrous oxide injection system begins with a connection to a supply cylinder containing pressurized liquid nitrous oxide and a connection to the engine’s fuel system. These connections go to the fuel and nitrous solenoids. These solenoids are normally closed, but are opened when the TPS switch senses that the nitrous system is armed and the engine is at wide-open throttle. Once these solenoids open, the nitrous and fuel are delivered to the nitrous nozzle via flexible delivery lines. The amount of nitrous and fuel that is injected through the nozzle is adjustable by means of metering jets installed in the nozzle itself. These metering jets allow for easy changes in horsepower settings.

**Work Safely:** Always wear eye protection and gloves when working with lines or hoses that contain pressurized nitrous oxide or fuel. Never transport nitrous cylinders loose in a trunk or the back of a pick-up

truck and especially NOT within a vehicle's interior whether the cylinder is full OR empty. Always disconnect the GROUND side of the battery when working on any electrical components.

**Nitrous Oxide won't fix problems you already have:** Before you install your nitrous system, be sure your engine is in good mechanical condition. Intermittent wiring problems, etc., can lead to erratic system performance and possible engine damage.

**Never defeat operation of the safety relief disc in the nitrous cylinder's valve:** It's required by law and is there for your safety. Never drill, machine, weld, deform, scratch, drop, or modify a nitrous oxide tank in ANY way whatsoever!

**Never overfill nitrous cylinders:** That little bit extra will put you and others at risk of injury. More often than not, when the cylinder warms up, the pressure goes above the limit of the safety relief disc and you lose all the nitrous you just paid for.

**All the power comes from the fuel, not the nitrous:** Nitrous oxide is simply a tool that allows you to adjust how much and how quickly the engine burns the fuel. If the fuel isn't there, the power won't be either.

**Avoid detonation at all times:** Nitrous enhanced detonation is much more damaging than detonation that occurs when naturally-aspirated due to the increased amount of fuel available for releasing energy and the fact that more oxygen is present.

**When the system is activated, if something doesn't feel or sound right, BACK OFF:** If you hear any detonation or feel anything unusual, get off the throttle. It's a lot easier to check everything over than it is to just try to drive through it and damage expensive parts. Don't activate or have the system activated when you hit the rev limiter.

**Spark plugs and nitrous performance:** Quite often, factory type, wide-gap, projected nose spark plugs will produce a detonation condition after a few seconds of nitrous use. The solution to the problem is to install spark plugs that have a colder heat range and proper ground strap design for nitrous use. Consult your preferred spark plug manufacturer to ensure you install the correct plugs for the nitrous level you choose to run. Also, due to the cooler and denser inlet air charge that nitrous creates, it may be necessary to close-up your spark plug gaps to eliminate any misfiring. In our experience, .030 to .035 in. spark plug gaps typically will ensure proper ignition. You may be able to run a wider gap, or you may have to close them up, just be aware of this if you start to experience an ignition misfire when you are using your nitrous system.

**Do not use Teflon sealing tape on any fittings in a ZEX™ Nitrous System:** It is easy for Teflon tape to get pulled into the system, causing blockages that can ultimately lead to incorrect nitrous system performance and potentially, engine damage. Only use liquid thread sealer for all NPT type fittings. Do not use any thread sealing compound on AN style threads.

**Do not attempt to start your engine if nitrous has been accidentally injected into the engine while it was not running:** Disable the ignition, and with the throttle wide open, turn over the engine for several seconds to clear the nitrous from the engine. Failure to do this before restarting the engine can lead to a dangerous intake system backfire.

**Do not engage your nitrous system below 2500 rpm:** This ensures that you will not have excessive cylinder pressures that could cause engine damage.

**When finished using your nitrous system, close the nitrous bottle valve and relieve the line pressure:** This eliminates the possibility that nitrous could inadvertently accumulate in the intake manifold while the nitrous system is not being used.

**Do Not Run Excessive Bottle Pressures:** Excessive bottle pressures, over 1100 psi, are dangerous to your engine. Your ZEX™ nitrous system is calibrated and optimized to operate from 900-1000 psi. Exceeding this will not improve performance. Over 1100 psi also runs the danger of locking the nitrous solenoid closed due to excessive pressure working against the valve's plunger. If this happens, you must cool the nitrous bottle down to lower the pressure. This will allow the valve to operate properly again.

**Start with the lowest horsepower setting and work your way up:** This ensures if you have any tuning issues to work out on your vehicle, they will get sorted out with a smaller shot of nitrous that will be less likely to damage your engine. Once you have the car working well on the smaller shot, you can then safely start to step up your nitrous kit horsepower.

**Make sure your vehicle has an adequate fuel supply:** Nitrous systems put a large demand on your vehicle's fuel system. Make sure you have a large enough fuel pump to handle the demands of your engine, as well as the nitrous system.

**How to adjust power levels:** The ZEX™ Race EFI Nitrous System is designed for multiple power levels. Metering jets installed in the nitrous nozzle control these power levels. To change the power output, all you need to do is install the appropriate set of jets. The correct combination of jets is listed on the tune-up sheet on the back of this instruction manual.

## **Installation Instructions**

### **Step 1: Decide where to put everything**

Before you start to install the various components of this kit, you'll have to find the best locations of each component by trial fitment and careful measurement. First, decide where you want to mount the nitrous and fuel solenoids. Remember, the stainless steel braided lines that connect the solenoids to the nitrous nozzle are 24 inches long. Observe and mark the location on the air inlet tube where you would like to put the nitrous nozzle. The arming switch should be installed in a position convenient to the driver, but not in an area where it could be accidentally armed. Next, decide where and how you'll mount the nitrous supply bottle, check Fig. 1, 2, 3, and 4 for technical restrictions on bottle mounting locations and positions. Finally, have a reputable performance shop fill your nitrous bottle with automotive grade nitrous oxide before you begin. Do not overfill the nitrous bottle.

### **Step 2: Mount Nitrous Supply Bottle**

1. Mount the nitrous supply bottle so that it is separated from the passenger cabin. Fastback style cars that do not have separate trunk compartments have to be equipped with a safety blowdown tube (ZEX™ Part # 82099). Route the tube from the safety pressure relief cap to the exterior of the car, preferably under the car. Doing so will prevent your car from filling with a cloud of nitrous oxide should the safety pressure relief cap rupture.

2. Index the pickup tube with bottle position. (Refer to fig. 1, 2, and 3). ZEX™ nitrous bottles are designed with the bottom of the siphon tube at the bottom of the bottle towards the outlet. Always mount the bottle so that as your car accelerates, the liquid flows toward the pickup tube.

### **Step 3: Mount Nitrous Delivery Line Under the Car**

When routing the nitrous delivery line under the car, try to use the subframe as a conduit (fig.4). This protects the line and eliminates the need to use clamps. The supplied cable ties work if you can run the line higher in the under-body so that it's safe from road level obstacles such as speed bumps.

## Step 4: Mount Nitrous and Fuel Solenoids

Assemble the -4AN filter fittings into the inlet side of both the nitrous and fuel solenoids. Install the 2 ft. long, -4AN hoses into the solenoid outlets. Make sure you use a liquid thread sealant on all NPT pipe threads. Attach the solenoid brackets to the solenoids using the pan head allen screws and find a suitable mounting location for them. Finally, attach the 16 ft. nitrous line to the inlet of the nitrous solenoid and attach the 3 ft. long, -4 AN fuel feed line to the inlet of the fuel solenoid.

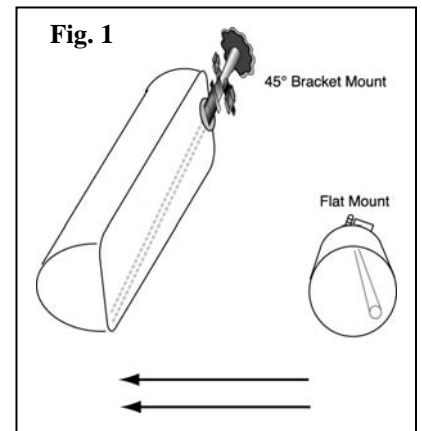

## Step 5: Install Nitrous Nozzle

Optimum nozzle placement is 6" to 18" from the throttle body. This range of distance gives the nitrous, fuel, and air, the proper time to mix before it enters the intake manifold plenum. After you have determined where to mount the nitrous nozzle in the intake, make sure this location won't interfere with other components. Mark the spot and remove the air inlet duct from your engine. Drill a 9/16 inch mounting hole and install the bulk head fitting through it. Be sure to remove any drill shavings since they can severely damage your engine if ingested. Install the nitrous nozzle so that the spray is in the direction of airflow. We've enclosed a tap (Fig. 5) should you need to mount the nozzle in a metal duct. Just drill an 11/32 inch hole where you want to mount the nozzle, tap the hole, and install the nozzle. Once the nozzle is installed, place the appropriate tuning jets in the nozzle and attach the 2-foot long, -4AN hoses that come from the solenoids (Fig. 6).

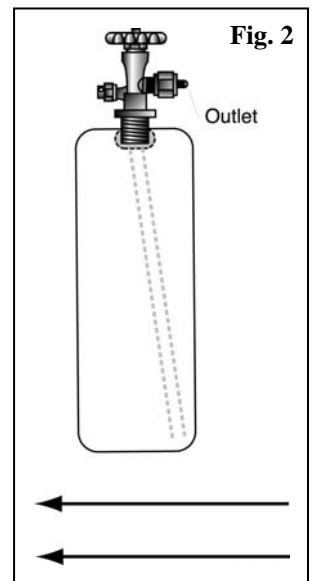

## Step 6: Wiring

1. Mount the arming switch in an easily accessible area for the driver.
2. Using the supplied electrical connectors and wire, refer to the wiring diagram for proper routing and electrical connections for the nitrous system (see Fig. 7). Always use the supplied fuse for electrical system protection in the event of a short in the system. The best positive (+) power source for the nitrous system's solenoids is a direct connection from relay post #5 to the battery's positive (+) post. Do not splice into the factory wire harness, it will not have the ability to supply the current required by the nitrous and fuel solenoids.
3. The next step is to program the Electronic Throttle Activation Switch. To begin, turn the vehicle's ignition on, but do not start the engine. Turn the nitrous arming switch to the "ON" position. Go to the Electronic Throttle Switch (ETS) and locate the push-button. Depress, then release, the push-button switch. Observe the ETS Operation Light. At this point, it should be RED. This RED light informs you that the ETS is in learn mode. Return to the driver's seat and depress the accelerator pedal to the floor, holding it there for ten seconds. Release the accelerator pedal and go back to the ETS and observe the Operation Light. At this point, the light should be flashing continuously from RED to GREEN to OFF. This is the ETC's way of telling you that it has successfully learned the voltage curve of your engine's throttle position sensor. Go back to the driver's compartment and turn off the system's arming switch, then turn it back on. Go back to the ETC and observe the Operation Light. It should be solid GREEN at this point. This informs you that the system is armed and

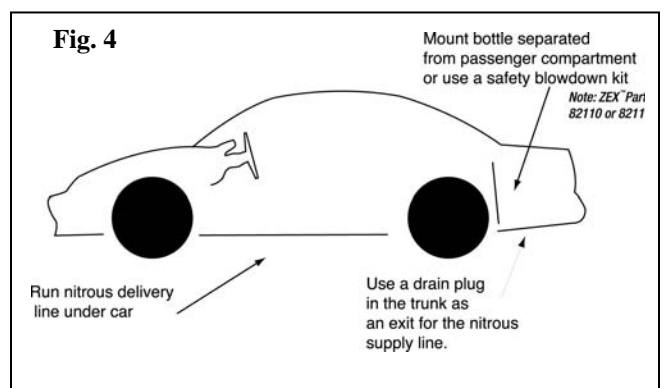
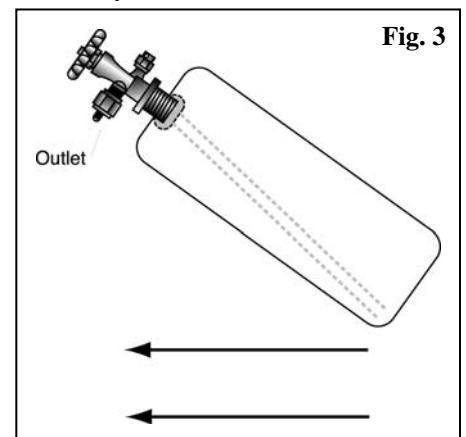

ready to activate at wide-open throttle. Return to the driver's seat and depress and release the accelerator pedal several times. You should hear the solenoids click each time you reach wide-open throttle. At this point, your Activation Switch is fully programmed and ready for use. If you ever transfer your nitrous system to another vehicle, perform this same procedure on the new vehicle to "relearn" the Throttle Activation Switch.

## Step 7: Install Fuel Delivery Line

**WARNING!! EFI fuel systems maintain fuel pressure, even after the vehicle has been shut off.**

1. Provide a source of fuel from the fuel rail and connect the 3 ft. long, -4 AN fuel feed line to it. For your convenience, several fittings are supplied with the kit that will make it easy to tap into your vehicles fuel system, use whichever one best suits your application. If needed, a -4AN to 1/8NPT fitting is supplied with a tap. Drill and then tap the fuel rail for this fitting. Make sure all metal shavings are removed before reinstalling the fuel rail.
2. Attach the 3ft., -4AN fuel delivery line, from the fuel source, to the fuel solenoid inlet.

## Step 8: Check Fuel and Nitrous Pressure Lines

1. Perform a final inspection of all plumbing and electrical connections to ensure that they are correct.
2. Ensure that the nitrous bottle is turned off and the line pressure is relieved.
3. Start the engine and observe all fuel connections for any leaks. Fix any fuel leaks before proceeding.
4. Turn off the engine.
5. Open the nitrous bottle valve. Listen carefully for any leaks as your valve is opened. Leaks in the nitrous supply line will be obvious because they will be covered in frost.
6. If everything checks out, close the nitrous bottle and relieve the line pressure.

## Step 9: Check Fuel Quality & Ignition Timing

The last thing to do before enjoying your new nitrous system is to ensure that the correct fuel for the HP you are making is in the tank and the engine's ignition timing is set correctly. All recommended ignition timing retard amounts, on the Tune-Up Sheet, are calculated off of the base ignition setting. It is important to set this with a timing gun before you use your nitrous system for the first time. Do not assume that it is set properly. If the ignition timing is not set correctly, severe engine damage may occur.

## Step 10: Enjoy!

After everything has been checked over and properly set-up, turn on the nitrous bottle and enjoy your ZEX™ Race EFI Nitrous System.

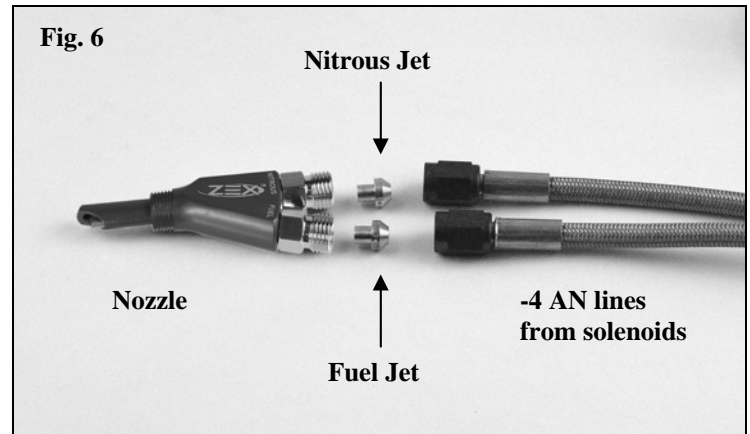
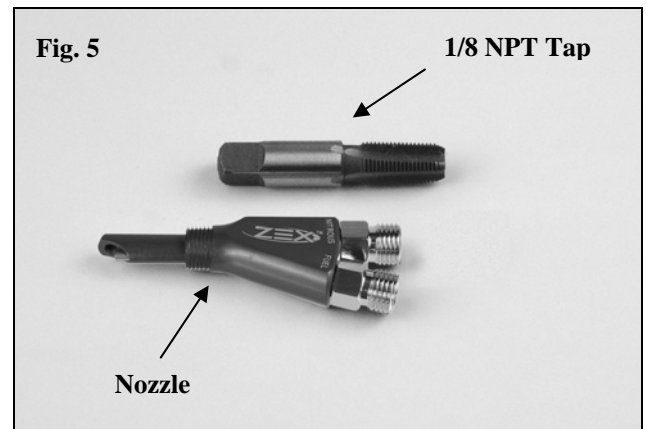

# **ZEX™ #82037 Nitrous System Tune-Up Sheet**

## **A word on why we have two different jet charts:**

When nitrous is sprayed into an engine, the nitrous gas itself displaces a percentage of the air that is normally drawn into the engine. Since engines that do not use a mass-air meter (i.e. speed-density) do not look at airflow, this displaced air does not affect the amount of fuel the engine computer feeds to the engine. But, on an engine that uses a mass-air meter, the air that is displaced by injecting the nitrous, lowers the airflow seen by the mass-air meter. This causes the engine's computer to reduce the engine's fuel injector flow rate. To compensate for this, the nitrous tune-up on a mass-air meter equipped engine is set-up to flow more fuel than an equivalent tune-up for a non mass-air meter equipped engine.

## **Jet chart for engines using a mass-air meter:**

	<b>100hp</b>	<b>150hp</b>	<b>200hp</b>	<b>250hp</b>
<b>Nitrous (950psi)</b>	52	64	74	88
<b>Fuel (40psi)</b>	30	36	43	52
<b>Ignition Retard (deg.)</b>	4	6	8	10

## **Jet chart for engines NOT using a mass-air meter (i.e. speed-density):**

	<b>100hp</b>	<b>150hp</b>	<b>200hp</b>	<b>250hp</b>
<b>Nitrous (950psi)</b>	52	64	74	88
<b>Fuel (40psi)</b>	26	30	34	38
<b>Ignition Retard (deg.)</b>	4	6	8	10

## **Normally aspirated tuning requirements:**

For engines less than 10.25-1 compression ratio, using nitrous system settings of 100hp or less, pump premium fuel is required for safe operation of your ZEX™ Race EFI Nitrous System. For engines with 10.25-1 compression ratio or greater, using nitrous system settings higher than 100hp, high octane racing fuel is required for safe operation of your ZEX™ Race EFI Nitrous System. Nitrous system fuel pressure must be at least 40psi at the inlet of the fuel solenoid. Base fuel pressures higher than 45psi may require a slight fuel jet adjustment to achieve optimum nitrous to fuel ratios. Track or dyno tuning will dictate this.

## **Forced induction tuning requirements:**

For engines under 8psi of boost, using nitrous system settings of 100hp or less, pump premium fuel is required for safe operation of your ZEX™ Race EFI Nitrous System. For engines using greater than 8psi of boost, using nitrous system settings higher than 100hp, high-octane racing fuel is required for safe operation of your ZEX™ Race EFI Nitrous System. Nitrous system fuel pressure must be at least 40psi at the inlet of the fuel solenoid. Base fuel pressures higher than 45psi may require a slight fuel jet adjustment to achieve optimum nitrous to fuel ratios. Track or dyno tuning will dictate this.

# Wiring Diagram

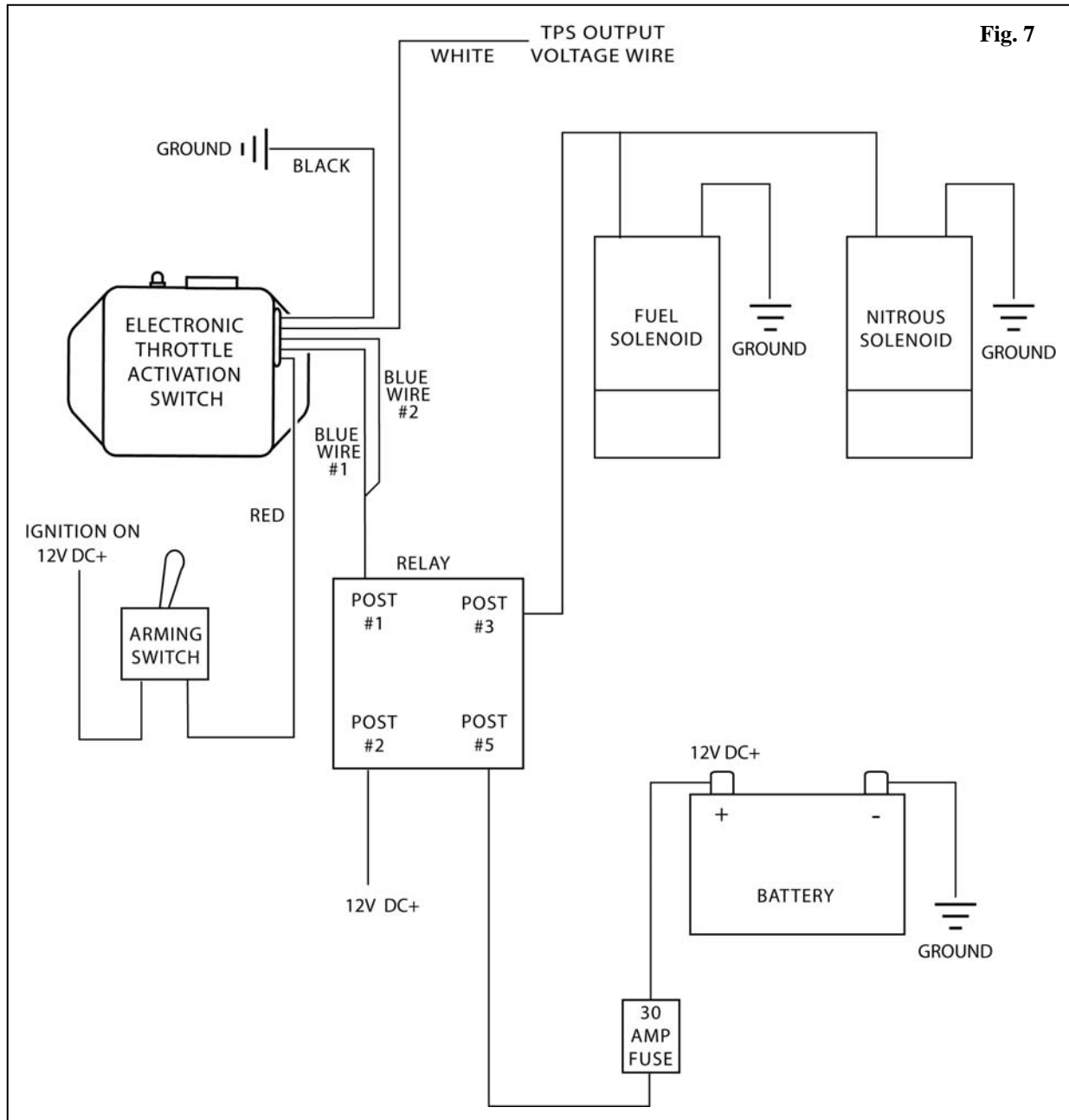

**3418 Democrat Road  
Memphis, TN, 38118  
1-888-817-1008**