



INSTALLATION INSTRUCTIONS

HIGH OUTPUT 2 SPEED RAD FAN ASSEMBLY

PART # 16816,16818,16819,16821,16822,16823 & 16828

Please read these instructions completely before beginning installation

KIT CONTENTS

QTY.	DESCRIPTION	QTY.	DESCRIPTION
1	Fan Shroud Assembly	16	1/4-20 x 3/4" Hex Bolts
4	Angle Brackets	16	1/4-20 Lock Nuts
1	Rubber Fan Shroud Seal	32	1/4" Flat Washers

TOOLS NEEDED

- 7/16" Open End Wrench
- 7/16" Socket and Ratchet
- Wire Stripper
- Wire Crimping Tool

Diagram #1

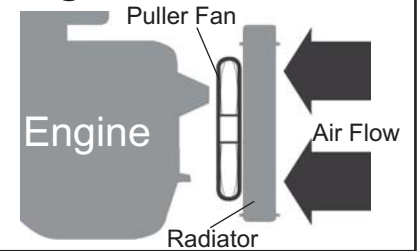

IMPORTANT

This fan assembly is designed for PULLER APPLICATIONS ONLY Engine side of radiator. (See Diagram #1)

MOUNTING OPTIONS

Diagram #2 Down Flow Radiator

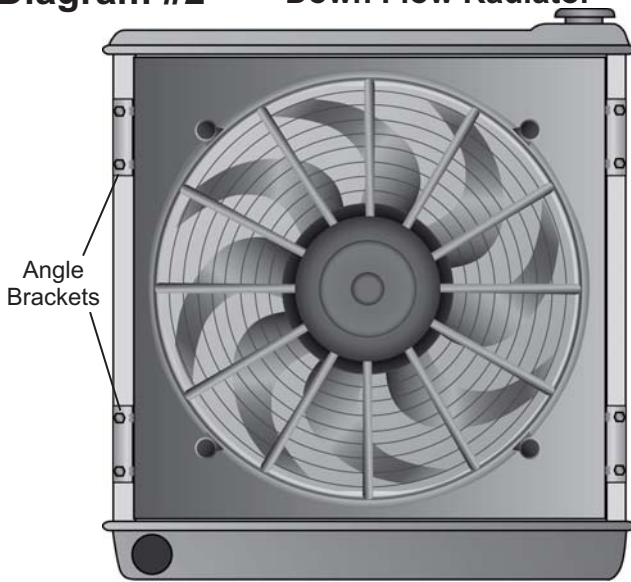

Cross Flow Radiator

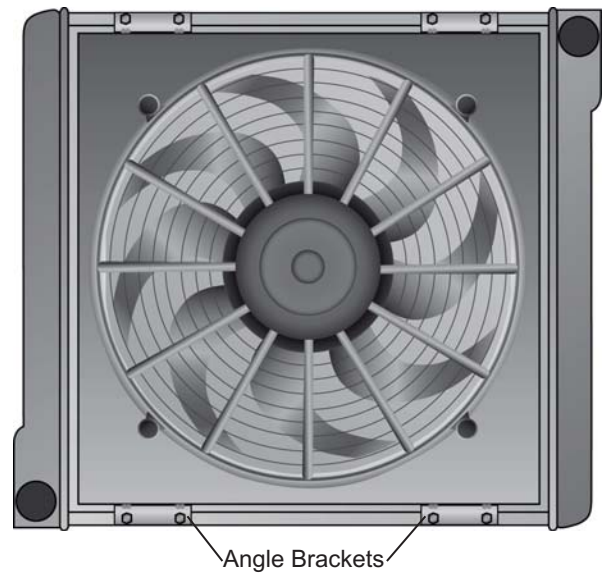
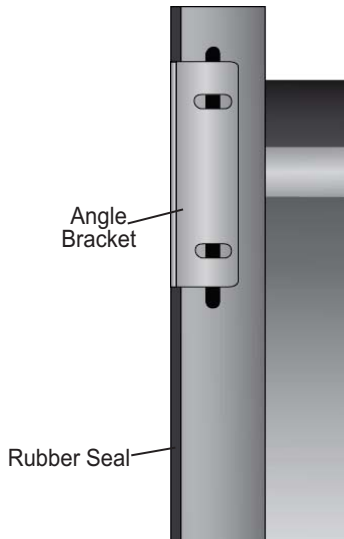
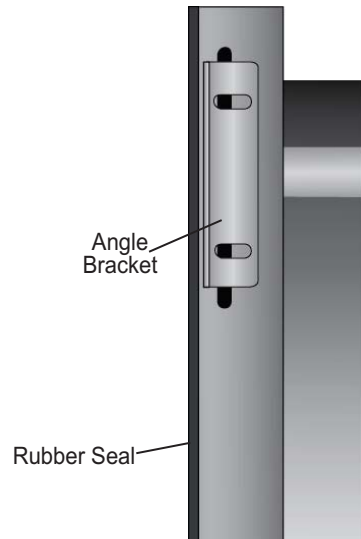

Diagram #3

Option 1 Flush Mount



Option 2 Recessed Mount



Adjustment Range

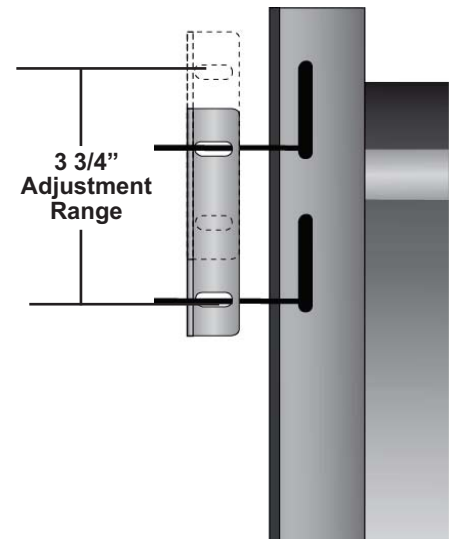

INSTALLATION

1. Using a table or workbench, lay the Electric Fan Assembly on a flat surface, Electric Fan facing down.
2. Take the supplied Rubber Fan Shroud Seal and install it onto the bottom edge of the Fan Shroud Assembly. (See Diagram #4)
3. Cut off any excess Rubber.
4. Identify the four Angle Brackets, 1/4-20 x 3/4" Hex Bolts, 1/4" Flat Washers & 1/4-20 Lock Nuts.
5. Attach the Angle Brackets to the Shroud using two bolts per bracket. (See Diagram #5)

Note: In some applications where the radiator flange is not right up against the fan shroud, longer bolts can be used to space the Angle Brackets. (See Diagram #6) Hardware not included!

6. Position the Electric Fan Assembly against the radiator in the desired location.
7. Using the remaining 1/4-20 x 3/4" Hex Bolts, 1/4" Flat Washers & 1/4-20 Lock Nuts, attach the Electric Fan Shroud Assembly to the radiator. (See Diagram #5)

Note: In some cases the radiator flange may have to be drilled for proper alignment.

Diagram #4



Diagram #5

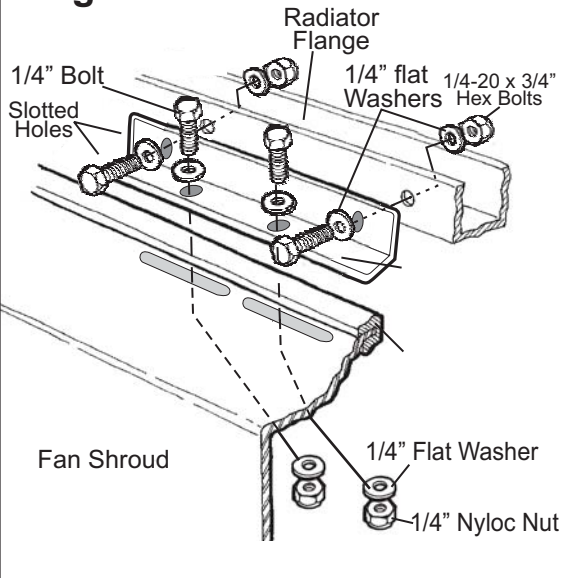
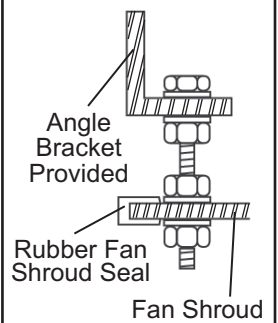

Diagram #6

OPTIONAL MOUNTING



WIRING

Important: The Electric Fan Assembly is built using a High Output two speed motor. If you choose to operate the fan using both speeds, two switching devices or a Derale Dual Fan Controller Part # 16788 / 16789 must be used.

Reference Diagrams #7 & 8 on page 3

WIRE COLOR DESIGNATIONS

Black Wire - Ground (-)

Grey Wire - Low Speed 12V positive (+)

Brown Wire - High Speed 12V positive (+)

STANDARD WIRING

Using High Speed Only - Connect both Grey and Brown wires together to the same 12V positive (+) source

Using Both Low and High Speeds - Connect Grey wire to Switch #1, 12V positive (+) source.

- Connect Brown wire to Switch #2, 12V positive (+) source.

Important: Low speed must be activated prior to high speed activation

WIRING OPTIONS

There are a few options on how to activate (turn on) your new Electric Fan Assembly.

1. Manual Switch with Relay - Install a switch in the passenger compartment and turn on Electric Fan as desired.
2. Electric Fan Thermostat Switch
 - A. Adjustable Thermostat - Allows an adjustment range for you to determine optimal turn on temperature.
 - B. Pre Determined Temperature - Thermostat has a pre determined temp. from the factory that determines turn on temp.

We recommend using two thermostats therefore activating the low speed at an earlier temperature then the high speed. Please visit www.dereale.com for available thermostat options or visit your local retailer.

Note: When purchasing a thermostat always consider the maximum amp draw. Some thermostats are not designed to properly handle higher amperage fans. When installing the Electric Fan with a Thermostat always follow manufacturer's instructions for specific details.

WIRING DIAGRAM WITH RELAY (RELAY NOT SUPPLIED)

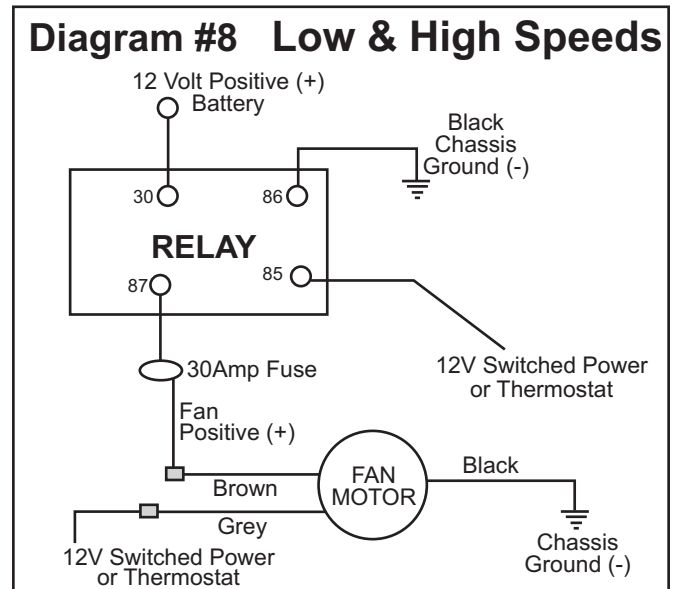
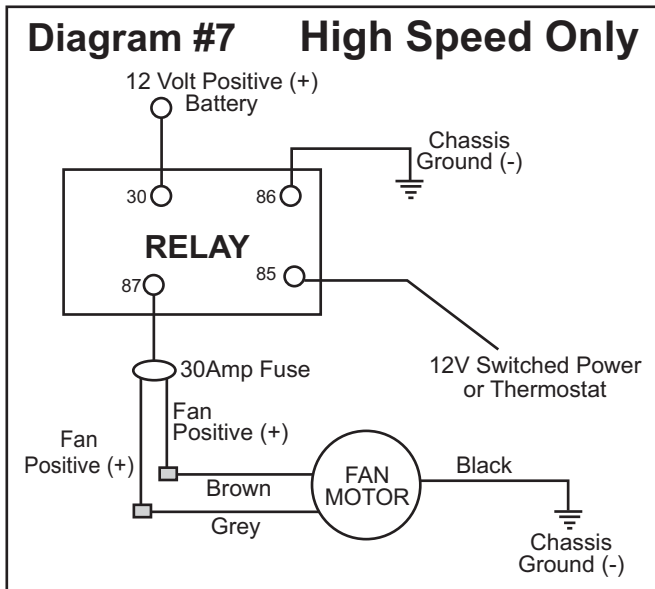

(Page 3)

Warning: Installation of accessories should only be undertaken by those with mechanical knowledge and are familiar with working on vehicles. Always use eye protection (goggles, safety glasses or shield). Park the vehicle in a well lit area, on level ground and apply the parking brake. Only work on a cold vehicle that has been sitting overnight, failure to do so will result in severe burns and injury. Before starting the vehicle, make sure no tools or any other items are left under hood that could interfere with or be drawn into moving parts of the engine. Failure to follow instructions can lead to severe damage and personal injury.