



3651 N Highway 89 • Chino Valley, AZ 86323
(928) 636-7080 • www.orfab.com

**JEEP JK & UNLIMITED
SWING-A-WAY TIRE/CAN CARRIER**
2007-2012 JK Kits # 85207

SWING-A-WAY TIRE ONLY CARRIER
2007-2012 JK Kits # 85208

NOTE
These instructions are for both the can and non-can style carriers. Installation of both systems are identical with the only difference being the shape of the main carrier itself. All pictures in these instructions reference the Tire/Can carrier model.

WARNING
Read and understand all instructions, warnings, cautions, and notes in this sheet and in your owners manual before you begin the installation of this tire/tire-can carrier kit.

CAUTION
Proper installation of a ORFab tire carrier kit requires knowledge of the factory recommended procedures for disassembly and assembly of original equipment components. We recommend that the factory shop manual and any special tools necessary to your vehicle be on hand during the installation. Installation of this tire carrier lift kit without proper knowledge of the factory recommended procedures may affect the performance of these components and the safety of your vehicle. We strongly recommend that a certified mechanic familiar with the installation of similar components install this tire carrier kit.

Before starting installation

WARNING
The load rating for these tire-can/tire carriers is a **MAXIMUM of 175 lbs.** Please be aware that some tire and wheel combinations along with gas cans and hi-lift jacks can **exceed** this **MAXIMUM** rating.

WARNING
Some states require a center high-mount stop lamp by law. OR Fab recommends that you consult your state laws before you install this kit. If required you'll need optional (CHMSL) kit# **87017**.

NOTE
Kit parts are prefaced by the word **kit** and appear in **bold print**.

1. Carefully read all warnings and instructions completely before beginning.
2. Verify all parts have been received in this kit by checking the parts list at the end of this document.
3. **Only install this kit on the vehicle for which it is specified.** If anytime during the installation you encounter something different from what is outlined in the instructions, call technical support at (928) 636-7080.
4. Park the vehicle on a clean, dry, flat, level surface and block the tires so the vehicle cannot roll in either direction.

Tools needed:

1. Angle Drill
2. 1" hole saw **OR** Unibit 335



Prepare to install kit

1. Remove spare tire.
2. Remove 3rd tail light and prep tailgate.
 - a. Remove factory spacer tire/third brake light mount.

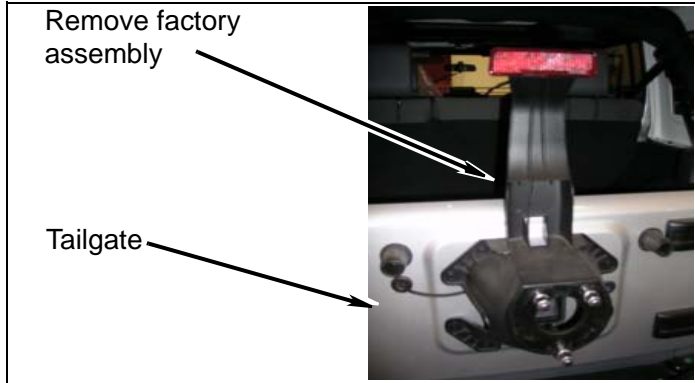

- b. Remove grommet and wire harness from tailgate.

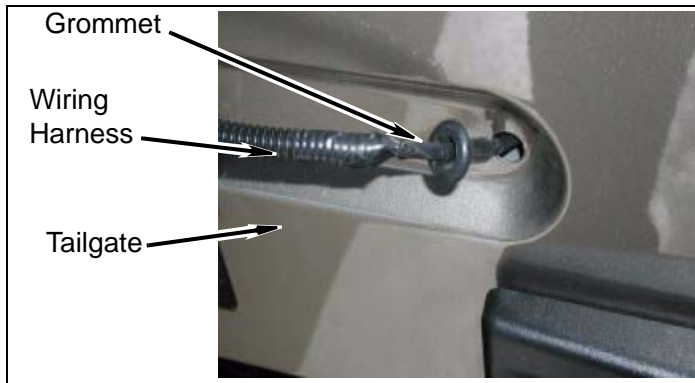

- c. Open tailgate. Unclip and remove both upper and lower plastic covers from hinges at tailgate and body. Make sure to mark upper and lower for reinstallation.

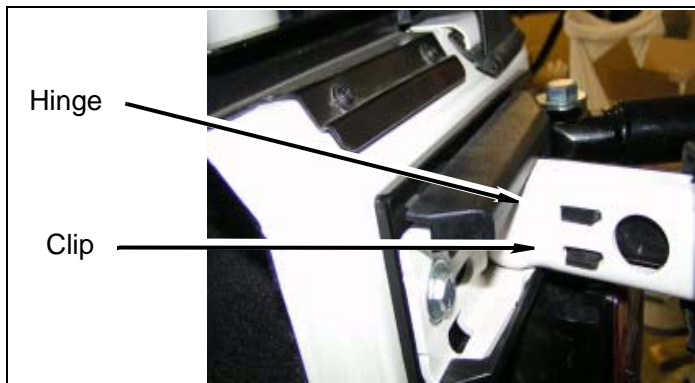

3. Remove tail lights.
 - a. Remove Tail lights from body. Only inner screws toward the tailgate on each light need to be removed.

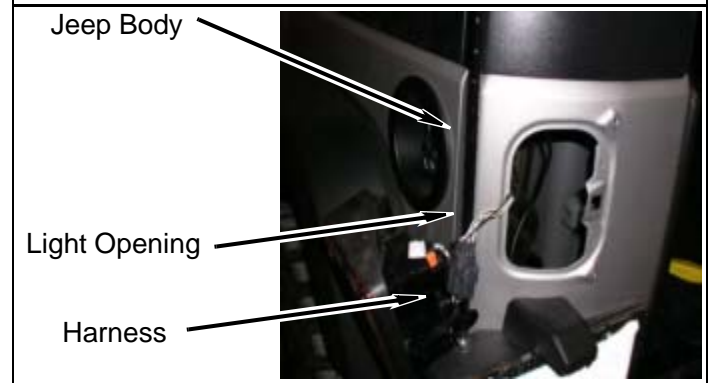
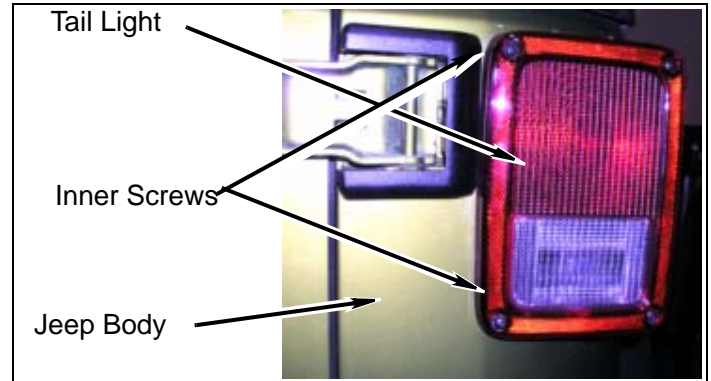

- b. Unplug lights from Harness.
- c. Remove Quarter panel inner foam liner both sides and save for reinstallation.

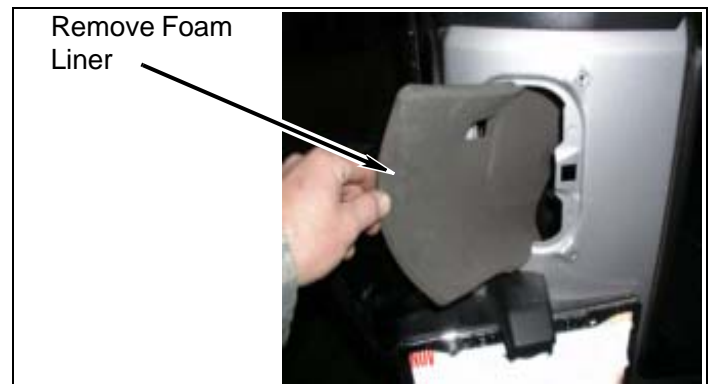

4. **2011-2012 Model:** Remove two T30 torque bolts and rear tail gate door guide from tail gate. Guide

will no longer be able to be used due to new tail gate position when tail gate is fully opened. .

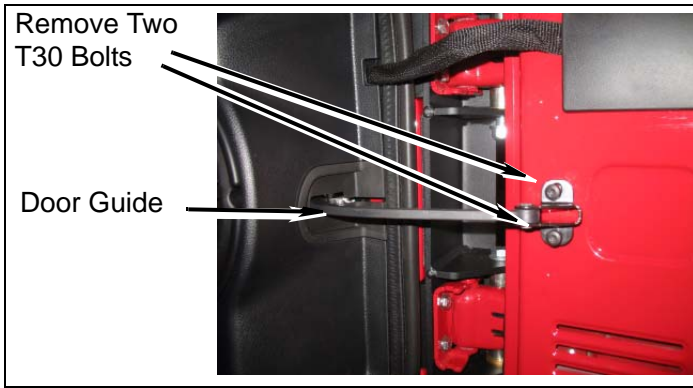

5. Remove tailgate hinge.

- a. With tailgate closed in lock position, place 2x4 block of wood under bottom edge to support.
- b. Remove both upper and lower tailgate hinges with a T50 Torx bit.

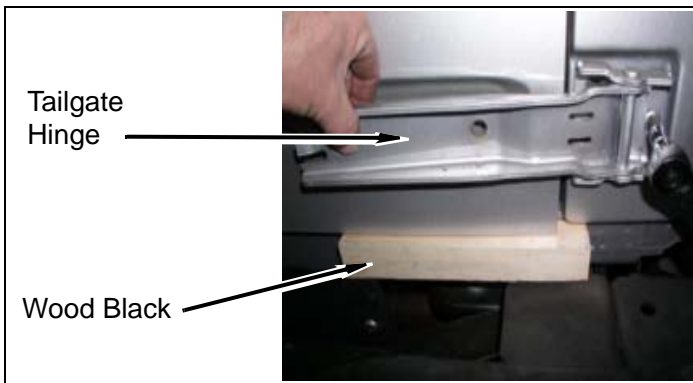

6. Clearance hinges for wrench

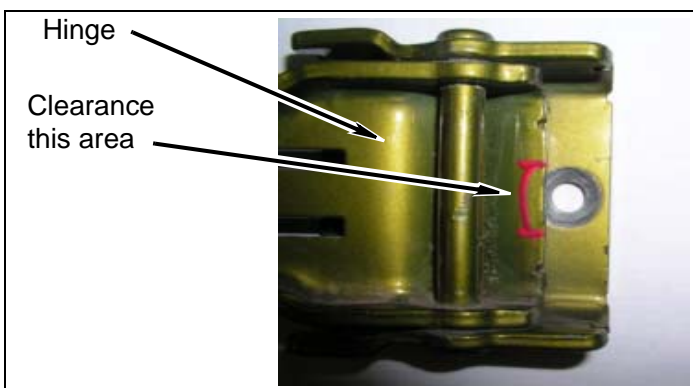

- a. Mark and grind out area shown on factory tailgate hinges to allow clearance for *kit bolt* (8mm & tapered washer) and wrench during install.

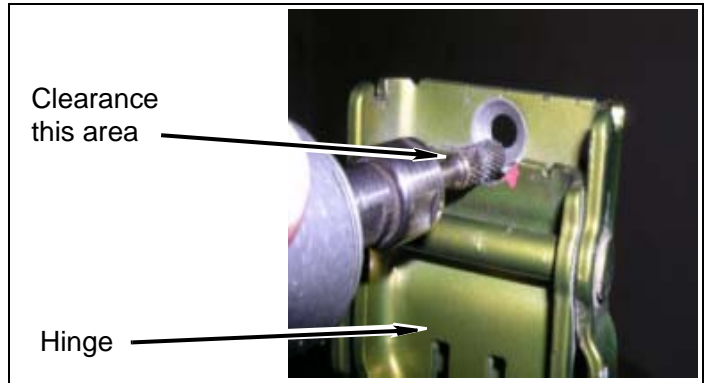

NOTE
Die grinder and rotary file work best for this task.

- b. Hinge should open and close with clearance of bolt head and 13mm wrench.



- 7. Install tailgate hinges, spacers, hinge plate spacers and hinge plate to jeep body. Make sure rounded edges of hinge spacer blocks are toward body.

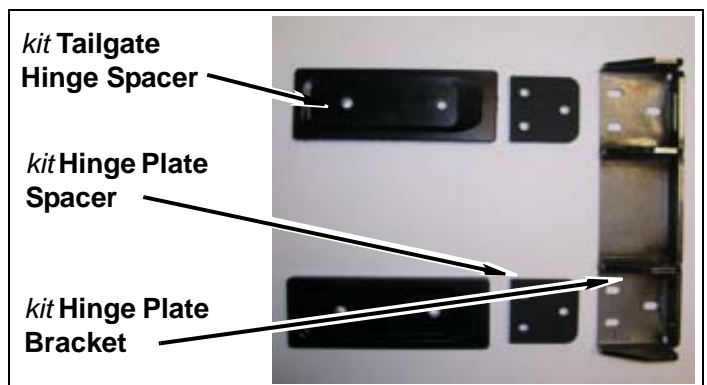

- a. On inner two holes of hinge, Install using *kit bolts* (8mm-1.25 x 50mm) with **taper washers** (8mm). Do not tighten at this time.

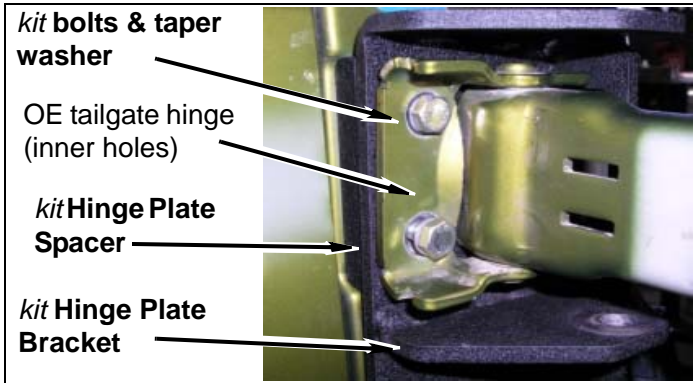

- b. On outer hole of top hinge, Install using one *kit bolt* (8mm-1.25 x 60mm) with **taper washers** (8mm). Do not tighten at this time.

- c. Install upper and lower tailgate spacers using four *kit bolts* (8mm-1.25 x 50mm) with **washers**. Do not tighten at this time.

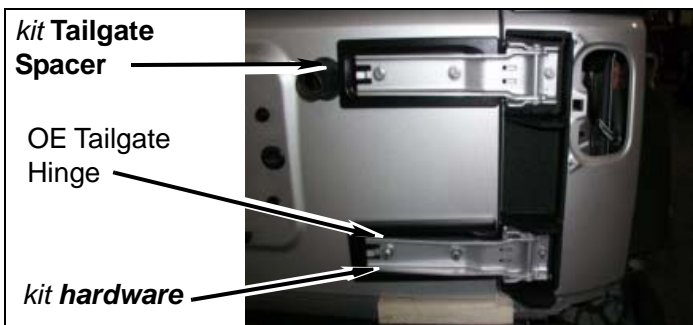

- d. Align tailgate and snug bolts.

NOTE
Lower tailgate hinge spacer has deeper dish area in face.

8. Install hing support bracket.

- a. Open tailgate and remove carpet from area of body around tailgate striker pad. Pull weather stripping from door edge.

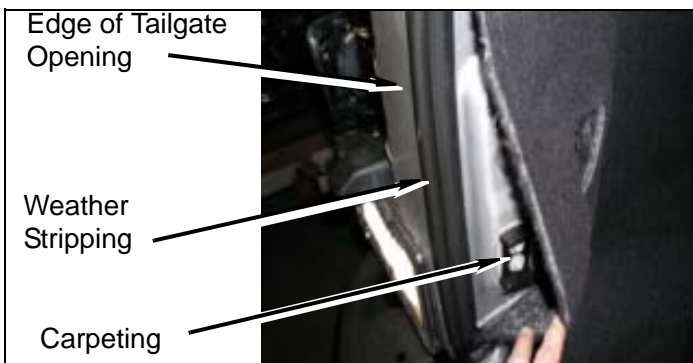

- b. Find the center of the door chanel and measure from inner lower corner of body up **3 7/8"** for first hole location and **10 7/8"** for second hole location center punch and drill **7/16"** hole on each as shown. (**Note:** Be sure to measure against flat sheet metal surface and *not* on top of body seam puddy. All JK's may need some minor adjustments made to these holes once bracket is set in place; due to variances in body panel positioning.)

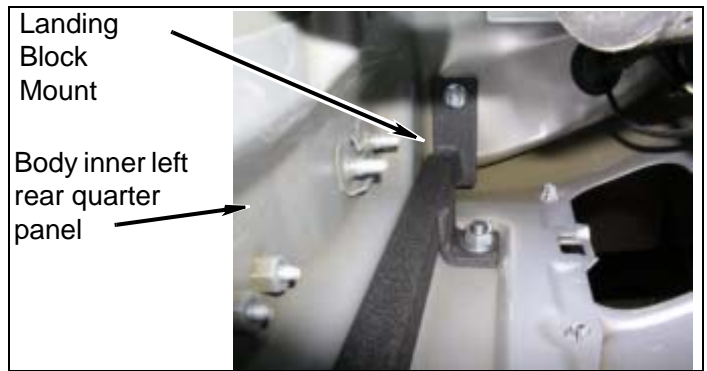
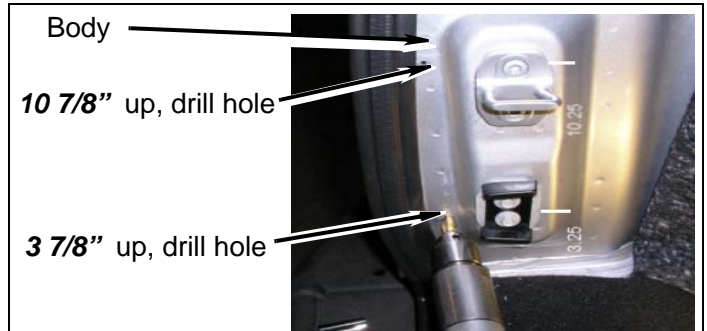

- c. Insert *kit landing block mount bracket* under left rear of body and align holes in bracket to holes drilled. Make sure **bracket** is snug to inner body corner. Install *kit bolts* (5/16" x 3/4") and **washers** into bracket and snug but do not tighten.

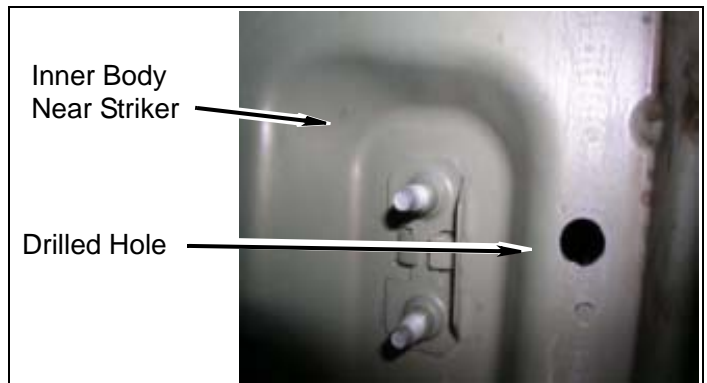

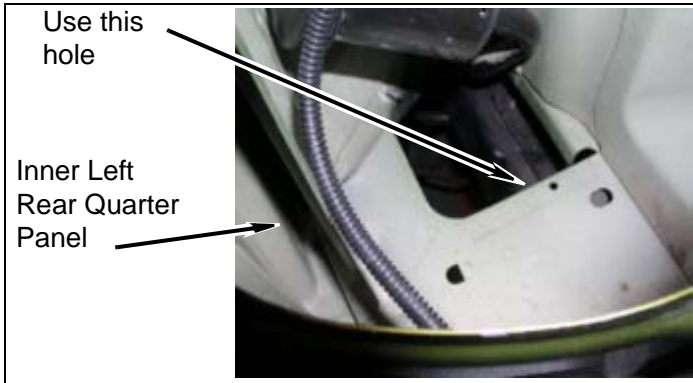

d. Align foot of bracket to location shown here and install **kit bolt** (1/4" x 1") with **hardware**.

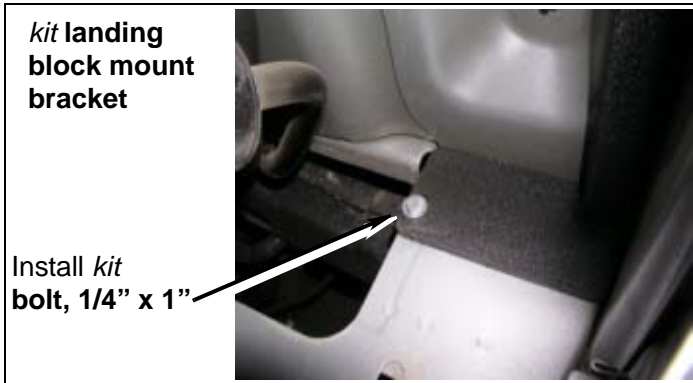

e. From underside of body center punch and drill upper hole into body with 1/8" pilot drill.

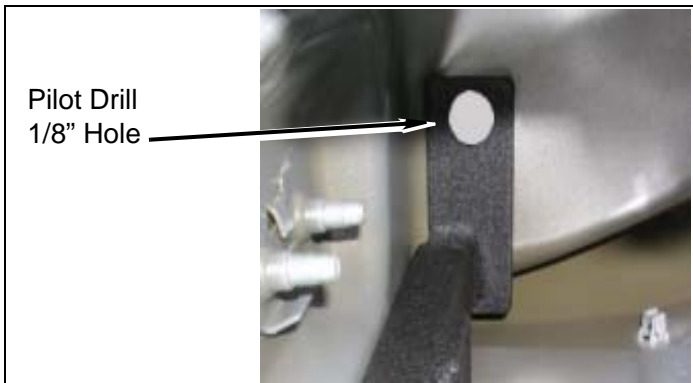

f. From top enlarge hole drilling with 3/8" drill and install **kit bolt** (3/8" x 1") and **hardware**.

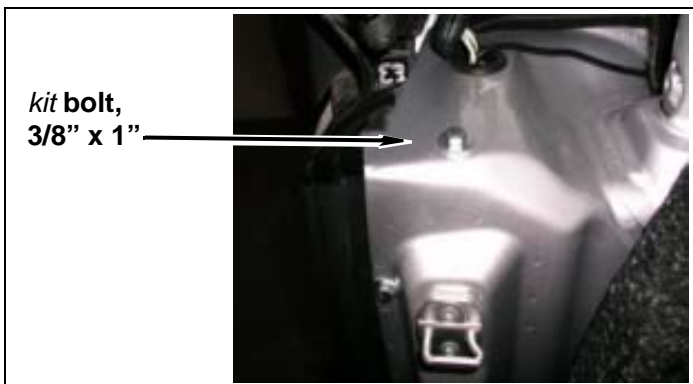

g. Tighten all installed hardware in previous steps.

9. Drill and hole saw for landing block.

a. From under-inside of body center punch remaining bracket hole on the rear inner body and drill a 1/8" pilot hole.

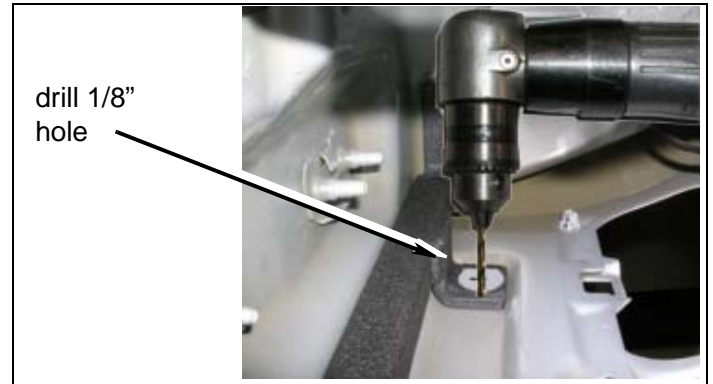

⚠WARNING

Careful to keep drilling straight through as you will drill two layers of body. An angle drill is highly recommended.

b. With hole drilled to outside of body as your pilot, use 1" hole saw through only first layer of body.

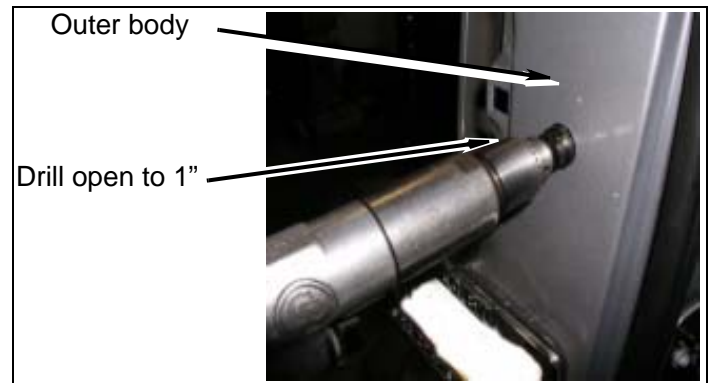

c. Drill out remaining inner body layer to 1/2"

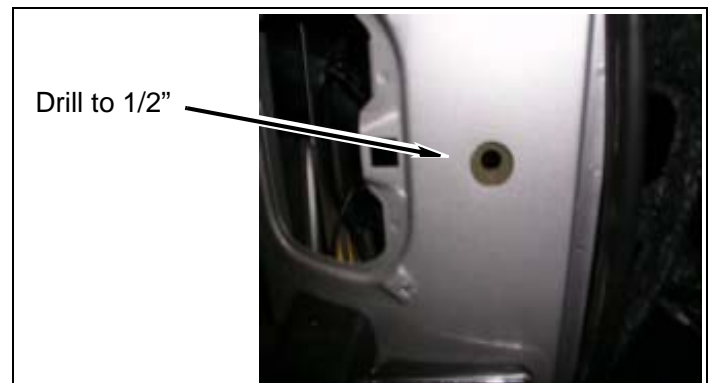

10. Install **kit landing block** to new hole in body support bracket with **kit bolt** (1/2" x 2"), **spacer** (1/2" x 1"), and **hardware**. Snug but do not tighten.

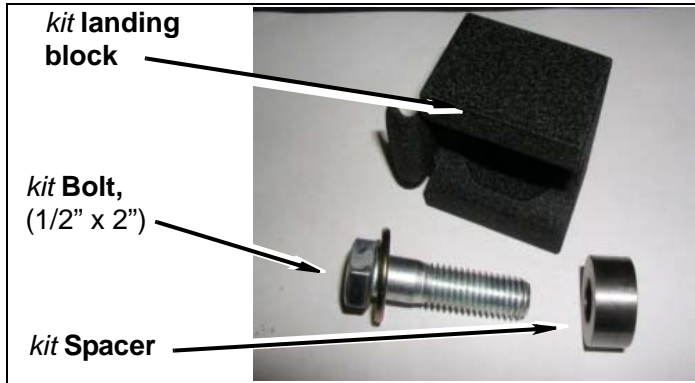

NOTE
Use RTV silicone sealer around spacer to make water-tight seal to body.

11. NOTE: The gap between the body and the landing block is required due to the contours of the body. This gap will help the rack align properly.

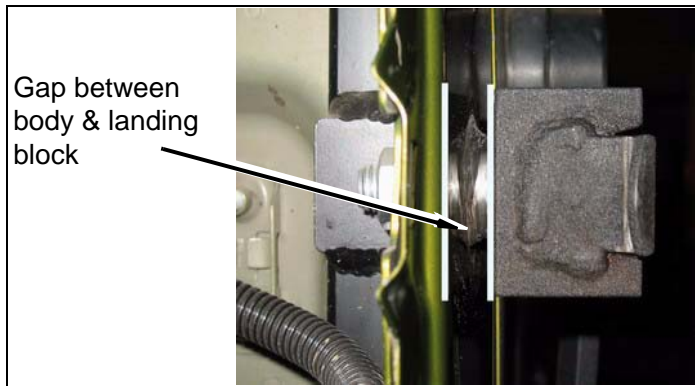

WARNING
Careful to keep drilling straight through as you will drill two layers of body. An angle drill is highly recommended.

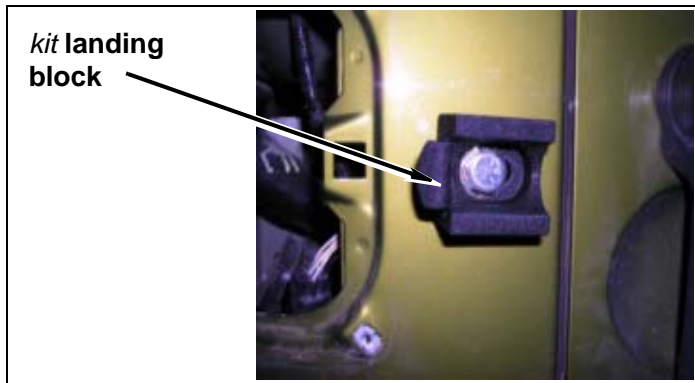

12. Install tire carrier rack to hinge plate with **kit bolts** (1/2" x 5-1/2") with **hardware** (1/2" brass washer, 1/2"

wave washer "shim", 1/2" sae washer, 1/2" lock nut, 1" spacer & 1.395" spacer)

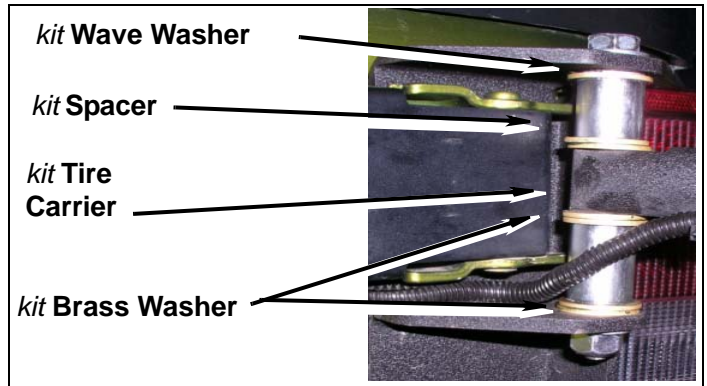

NOTE
Place washers and spacers in order shown below. If you have space or gap in the pivot washers use wave washers or extra washers included for shimming. On lower pivot spacers will be opposite position as top. Use small amount of lithium grease on face of brass washers to give better movement.

13. Adjust and tighten



- a. Close and latch rack.
- b. Hinge plate has cut-out for 13mm box wrench to tighten and for adjustments. Tighten both upper and lower outside hinge plate bolts through cut-outs.

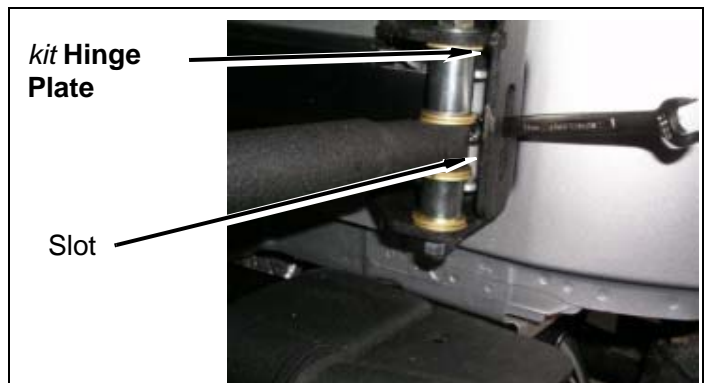

- c. Now open carrier rack and tailgate to tighten inner hinge plate bolts.

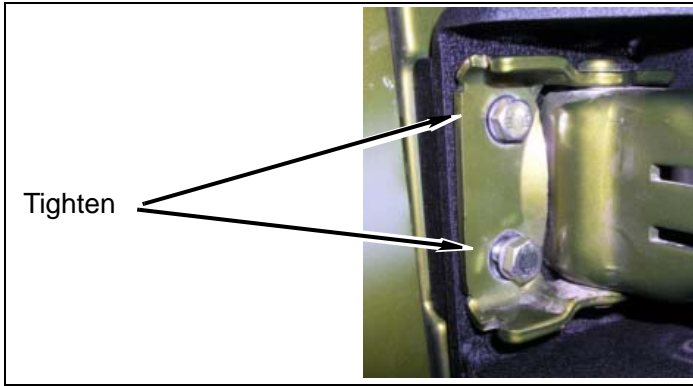

- d. Tighten Landing block position so hook area of block just has enough clearance for landing bar of rack, block is slotted for this adjustment. Adjust rack latch hoop and tighten jam nut, this will allow the latch to properly cam-lock itself when in closed position.

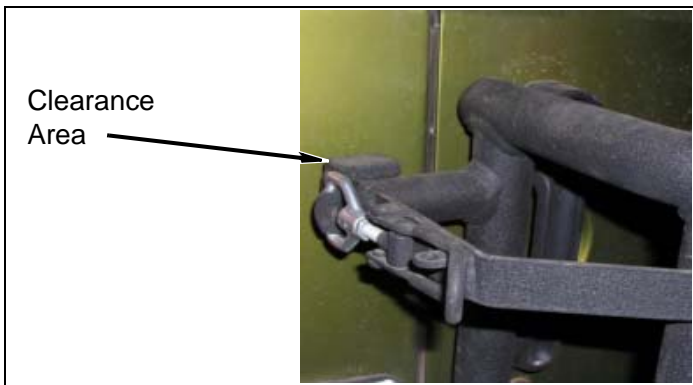

- e. Adjust tail gate for proper closing and tighten all remaining bolts inside body. Reinstall tail gate hinge plastic covers.

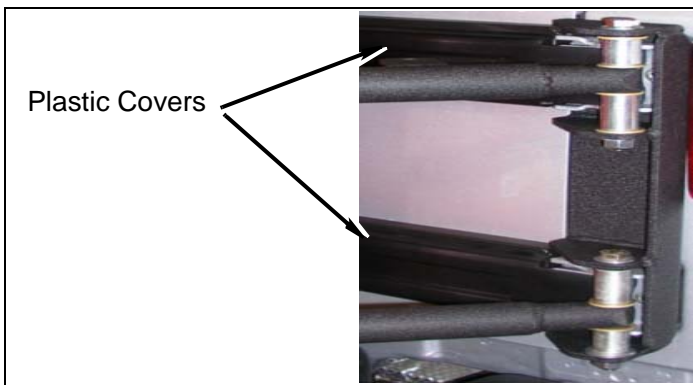

- f. Install on the back side of upper and lower hinge plate using *kit nut* (8mm flange) and tighten (exclude upper outer longer bolt for next step.)

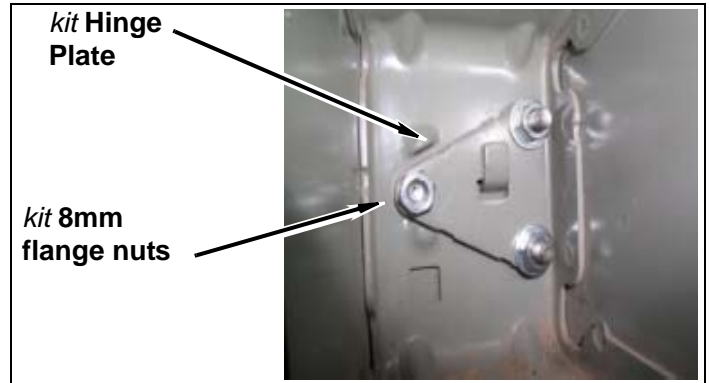

14. Install *kit hinge plate upper support bracket*



- a. On underside of body top mount plate, place bracket end on upper outer long hinge bolt shown. Secure with *kit nut* (8mm flange)

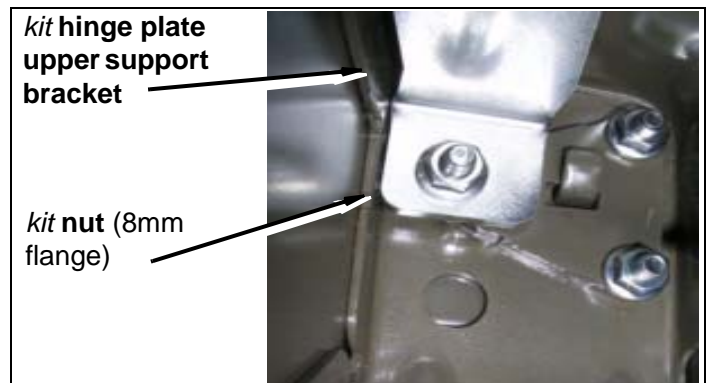

NOTE
Mechanics mirror will greatly help in this step.

- b. On opposite end of bracket center punch and pilot drill 1/8" hole up through the body.

- c. From top side inside of body enlarge hole to 3/8" drill and install *kit bolt* (3/8" x 1") with **hardware** and tighten.

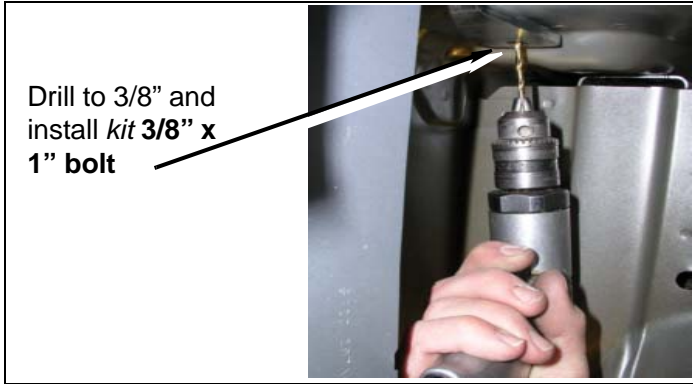

15. Reinstall quarter panel inner foam liner and tail lights

16. Tire mounting.

⚠WARNING

The load rating for these tire-can/tire carriers is a **MAXIMUM** of **200lbs**. Please be aware that some tire and wheel combinations along with gas cans and hi-lift jacks can **exceed** this **MAXIMUM** rating.

- a. Install *kit lock bar* on *kit tire carrier* with two *kit bolts* (5/16" x 1") and two *kit flange nuts* (5/16").
- b. Position and install tire and wheel assembly on *kit tire carrier* with *kit urethane spacer*, *kit aluminum plate*, and *kit T-bar*.

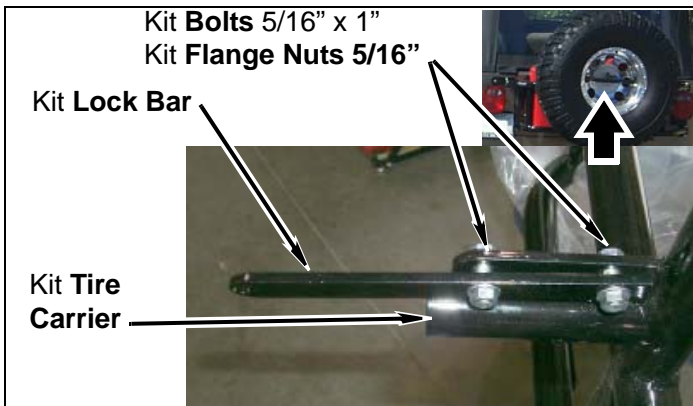

17. Kit bump-stop.

⚠CAUTION

In the step below you may need to slightly grind the face of the *kit lower bump-stop* so that it will not dent the tailgate. When adjusted properly the *kit lower bump-stop* should just touch the tailgate and the *kit 2" x 2" stainless stick pad*.

- a. Install the *kit lower bump-stop* on the *kit tire carrier*.

- b. Use the location of the *kit lower bump-stop* on the tire carrier to position the *kit 2" x 2" stainless steel stick pad* on the tailgate.

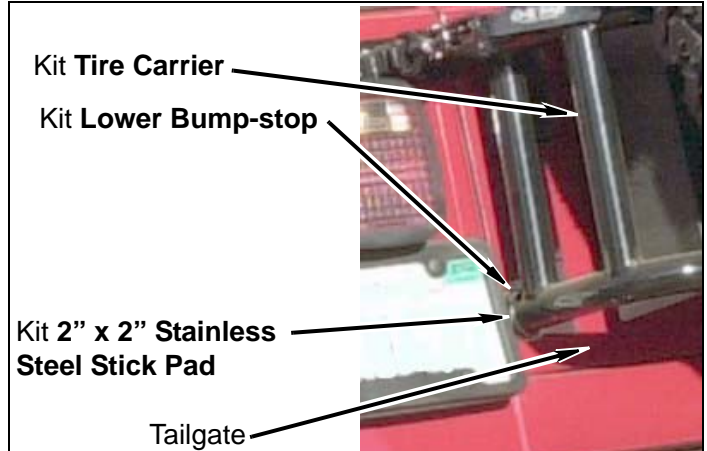

- c. **Tire-can carrier only:** Install your gas cans on tire-can carrier using the bottom lip of the cans along with two *kit threaded rods* (3/8 x 8"), *kit L-brackets* and *kit wing nuts* as shown.

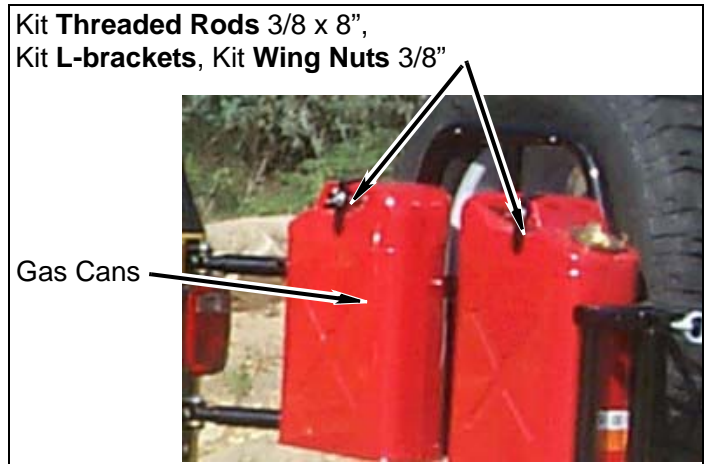

⚠NOTE

After installing tire and cans to rack, carrier may seem to sag at latch end. Set pre-load to rack by adjusting hinge plate landing bar to landing block is just above center of landing area. This will set pre-load after weight is applied and will close properly.



Accessories

The following accessories are also available:

Kit # 87013: Non-lip can carrier adapter.

Kit # 87269: Cargo box.

Kit # 87017: Third brake light kit

- 1 Bolt, 1/4" x 3/4"
- 4 Washer, M8
- 1 Washer, 1/2" SAE (Hardened)
- 16 Washer, 1/2" Brass
- 2 Washer, M12
- 4 Washer, 1/2" SAE
- 2 Washer, 7/16" USS
- 2 Washer, 5/16" USS
- 3 Washer, 1/4" USS
- 6 Washer, M8 (90 degree)
- 1 Nut, 1/2" Flange
- 2 Nut, 1/2" Stover
- 2 Nut, 3/8" Flange
- 2 Nut, 5/16" Flange
- 1 Nut, 1/4" Flange
- 6 Nut, M8 Flange
- 2 Nut, 3/8" Wing
- 1 Spacer, Landing Block (.5 x 1.0)
- 2 Spacer, Pivot (1.395 x 1.0)
- 2 Spacer, Pivot (1.008 x 1.0)
- 1 End Cap, Urethane
- 1 Bumpstop
- 1 Self Adhesive 2" x 2" Pad

△NOTE

Hi-lift jacks can be installed on the tire-can/tire carriers with the use of two bolts (3/8" x 1 1/2") not provided with these kits.

Parts list

QTY Description

- 1 Rack, Carrier
- 1 Bracket, Hinge plate
- 1 Bracket, Landing block mount
- 1 Bracket, Support mount upper
- 1 Spacer, Tail gate hinge lower
- 1 Spacer, Tail gate hinge lower
- 2 Spacer, Hinge plate block
- 1 Landing block, Welded
- 1 T-Handle
- 1 Aluminum Disc
- 1 Spacer, urethane disc
- 1 Lock Bar
- 2 Can Clamp
- 2 Can Holder

- 1 Hardware Bag, (Tire Carrier)

- 1 Bolt, M8 x 60mm
- 9 Bolt, M8 x 50mm
- 2 Bolt, 1/2" x 5-1/2"
- 1 Bolt, 1/2" x 2"
- 2 Bolt, 3/8" x 1"
- 4 Bolt, 5/16" x 1"

Rev. 2 © 2008 OR-FAB
Performance Automotive Group, Inc.