

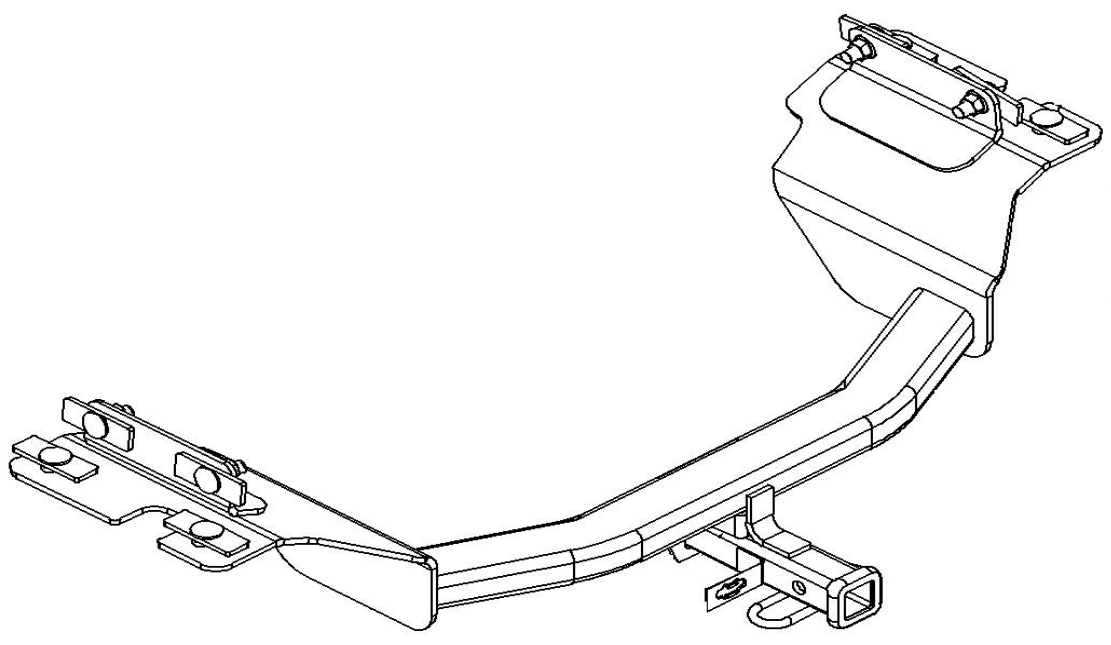

# DODGE DART TRAILER HITCH

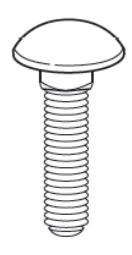

**A**



**8x**

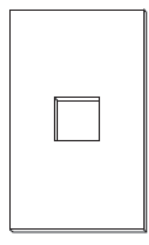

**8x**



**8x**



**8x**

**B**

**C**

**D**

**E**

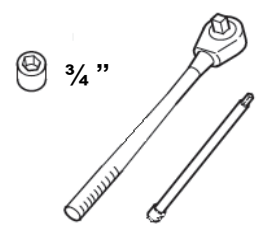
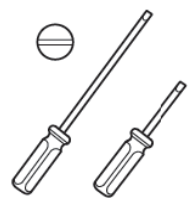

3/4"

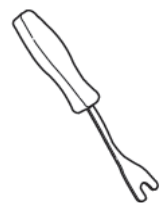
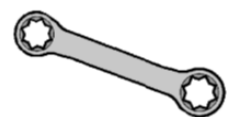
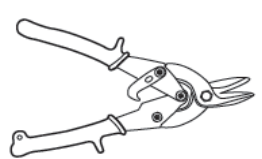

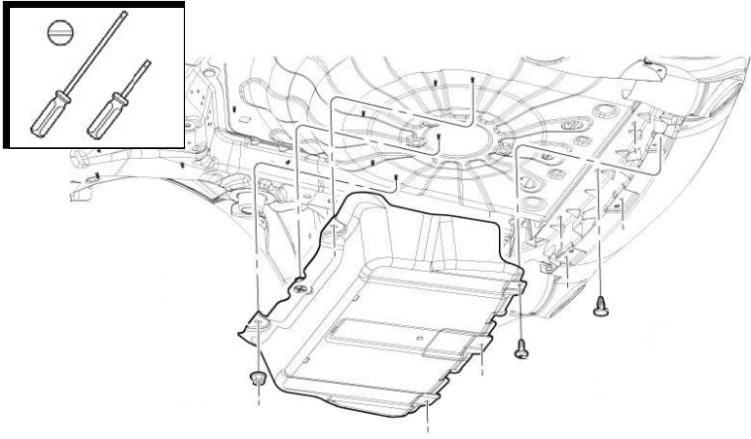

1

Remove center aero shield, and middle rear fascia nut to be installed on back side for the hitch receiver.



2

Support muffler



3

Remove muffler hangers

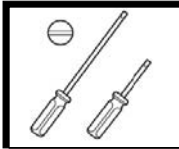

4

Remove chrome tips if necessary

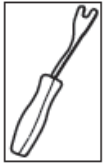

5

Remove access hole covers in both rails

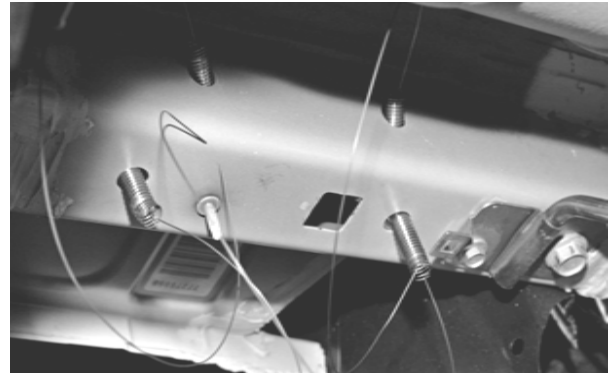
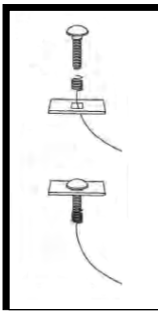

6

Insert bolt assemblies into rails

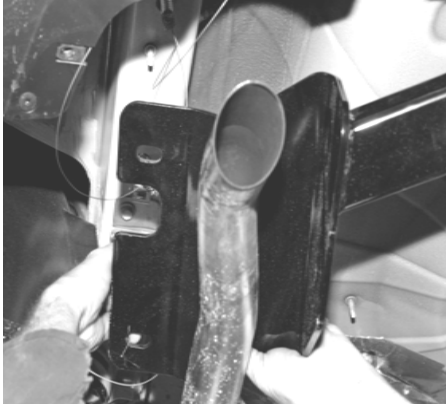
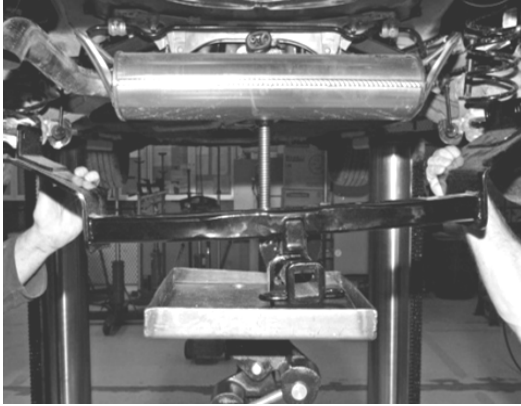
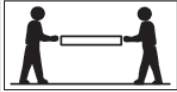

- 7** Lift trailer hitch into place while inserting fish wires through corresponding holes in trailer hitch. Insert drivers side first to position around muffler. Avoid the hanger tab. Remove the fish wires and hand tighten all the nuts.

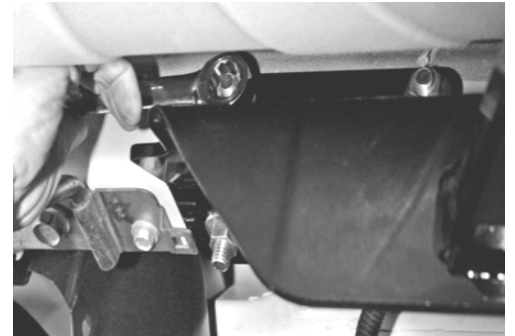
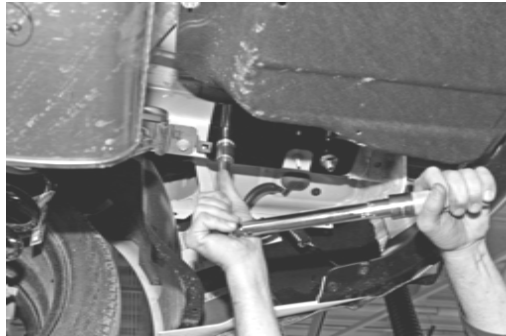
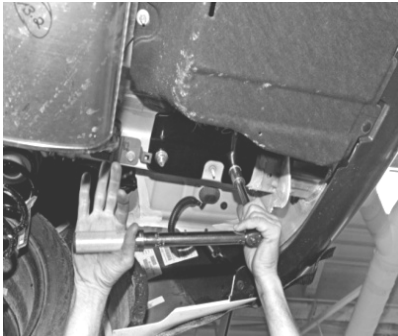
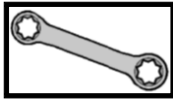

- 8** Tighten vertical nuts first. Torque all nuts to 75 ft-lb (102 N m).

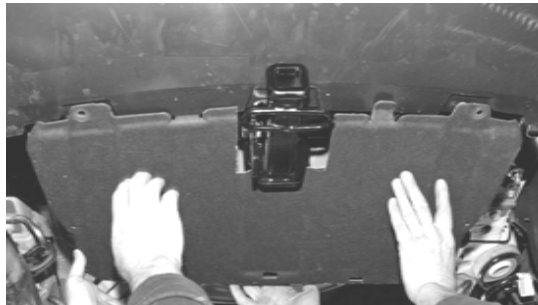
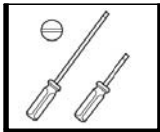
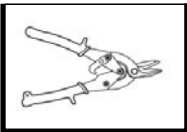

- 9** Trim center aero shield at marked lines. Re-install muffler isolators. Install clip nut from center hole on aero shield to front of hitch. Re-install center aero shield. Poke hole for center clip nut and reinstall fascia screws.