

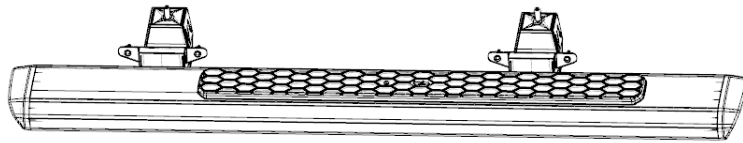

Jeep Wrangler

Tube Step - 2 Door



A LH

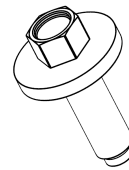

C 4x

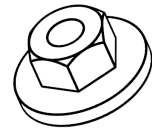

D 8x

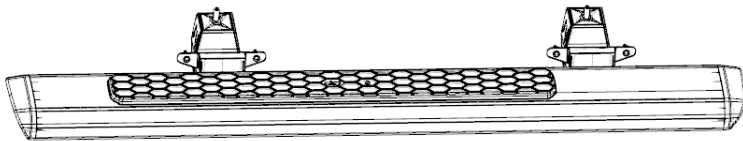

B RH

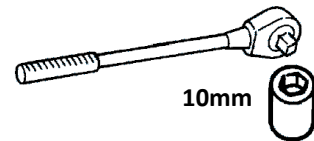

10mm

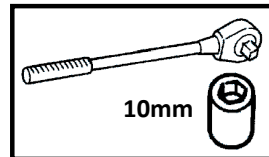
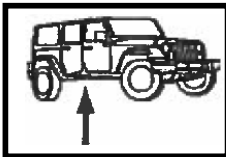

10mm

C 27.5 ± 2.8 Nm

D 13.0 ± 1.3 Nm

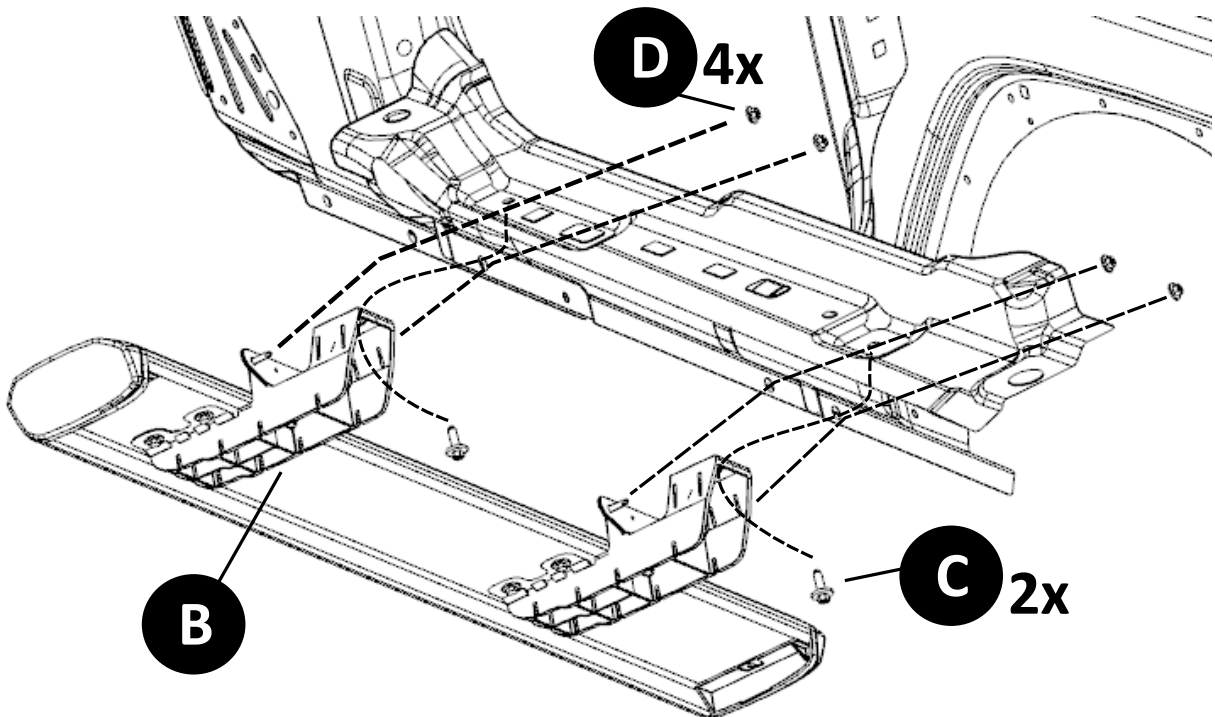

Note: Repeat for other side