

# EGR INSTALLATION INSTRUCTIONS

### Tools Required

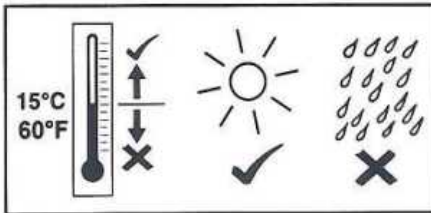

1• Clean and dry the vehicle. Lower the front windows completely.

2• Fit the front section of the Window Visor behind the mirror base. Ensure the bottom edge of the Window Visor locates on top of or over the lower window molding, as shown.

3• Fit rear section of Window Visor into channel about 1/2 inch away from the top of door frame, as shown.

**IMPORTANT:**  
When fitting the Window Visor it will be necessary to bend the center of the Window Visor away from the vehicle to enable fitment into the rear section of the door channel.  
**CARE MUST BE TAKEN AS THE PRODUCT COULD BREAK.**

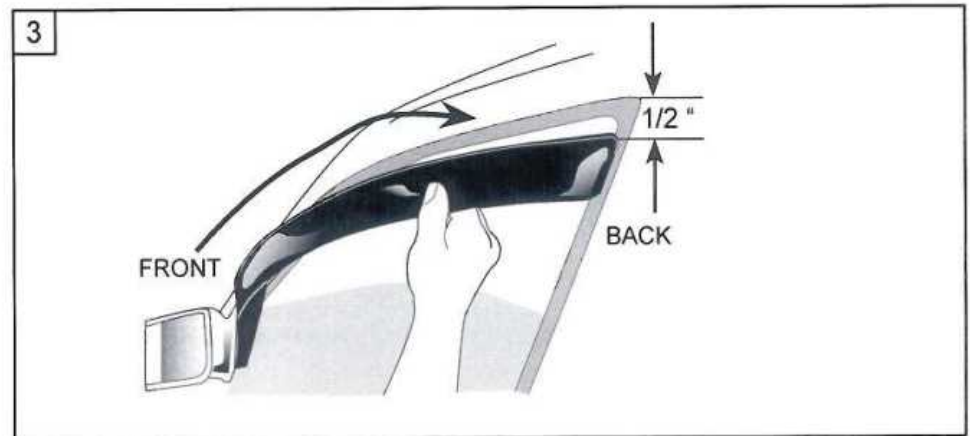
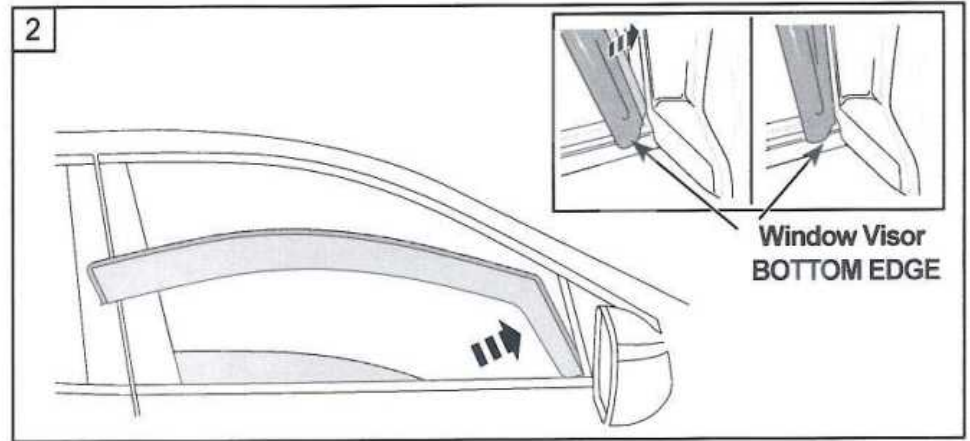
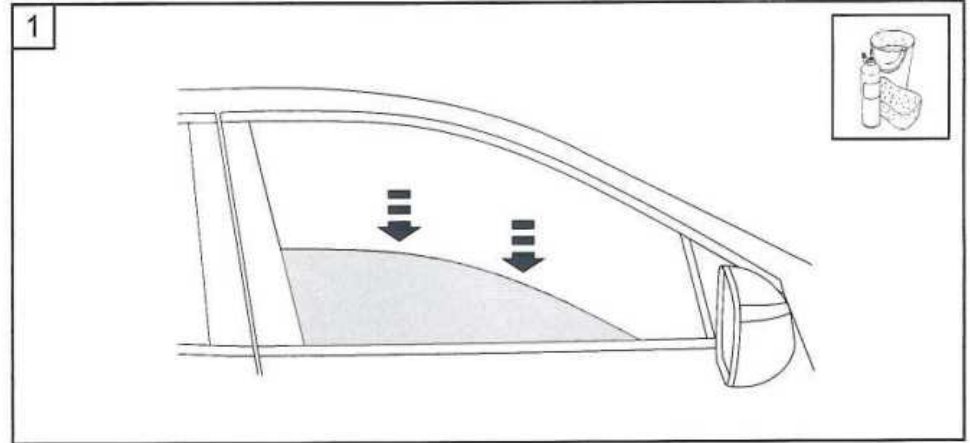

# EGR INSTALLATION INSTRUCTIONS

### Tools Required



**BEFORE  
INSTALLING  
PRODUCT,  
PLEASE READ  
INSTRUCTIONS  
FULLY**

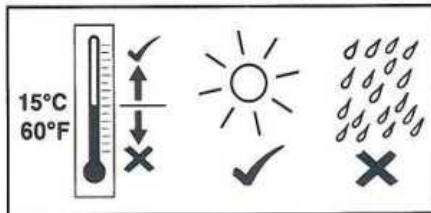
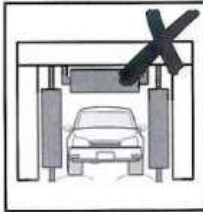

- 4• Start inserting the Window Visor by carefully rotating the Window Visor into the window channel.

**IMPORTANT**  
Working from the front of the Window Visor to the back as shown. Once installed gently push the Window Visor upwards into the window channel.

- 5• Ensure the Window Visor is located in the outermost section of the rubber window channel. Pull the bottom of the Window Visor outwards at the rear of the part while raising and lowering the window a minimum of 5 times to help seat the Window Visor into the rubber window channel.

**IMPORTANT:** Before fitting product, read instruction fully. Full tape strength is achieved after 72hrs. Allow tape to cure for 4hrs before driving vehicle. Reverse the above procedure to remove this product.

**To Clean:**

- Use mild detergent and water solution
- Do not use solvents
- Avoid the use of automatic "Brush Style" car washes.
- When closing the hood, do not pull on Hood Protector.

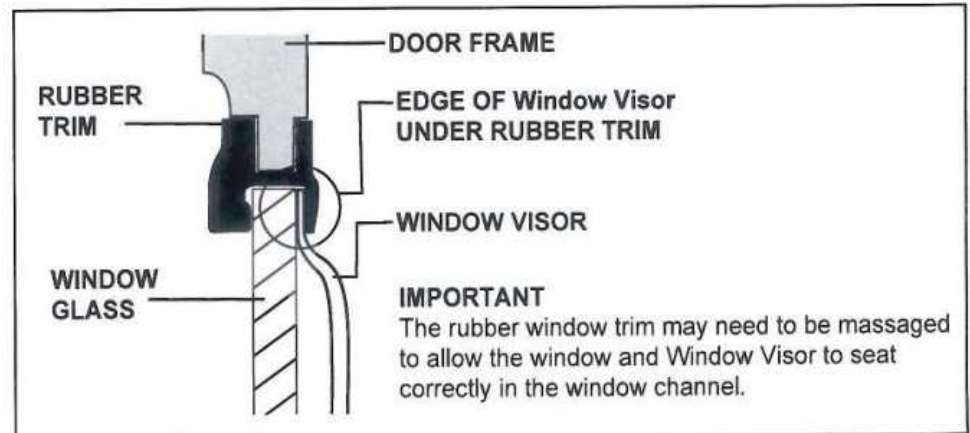
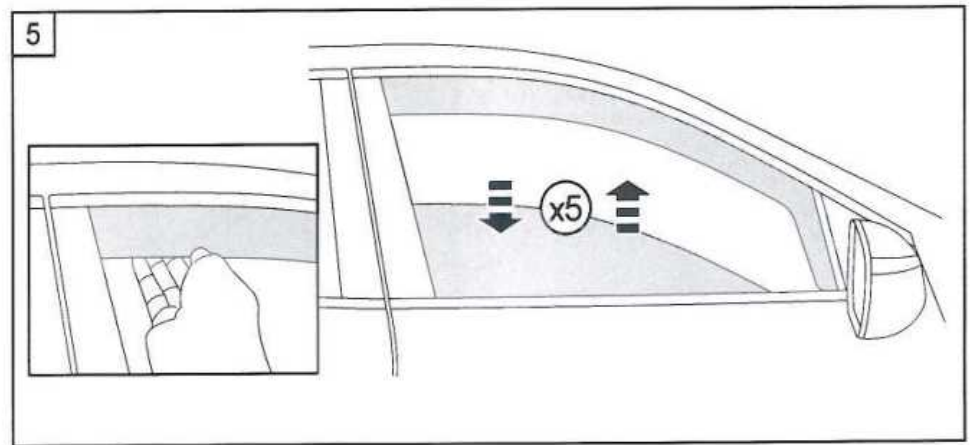
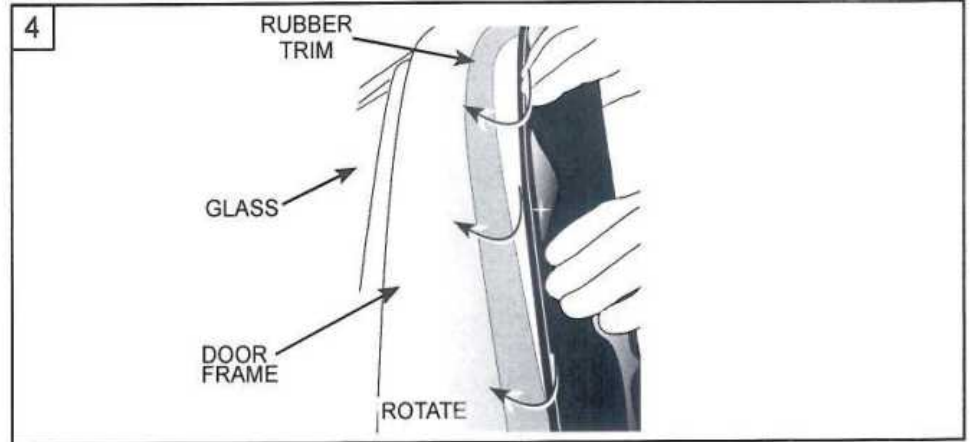

# EGR INSTALLATION INSTRUCTIONS

Tools Required



**BEFORE  
INSTALLING  
PRODUCT,  
PLEASE READ  
INSTRUCTIONS  
FULLY**

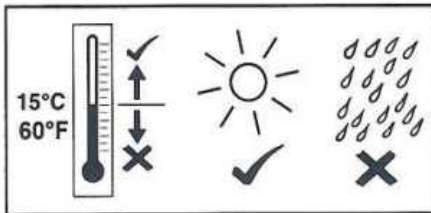
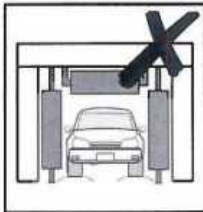

1• Clean and dry the vehicle. Lower the rear windows completely. Remove the tape liner from the double-sided tape attached to the window visor.

2• Fit the front section of the Window Visor into the rubber window channel, as shown.

The half notch at the end of the Window Visor indicates the rear end of the Window Visor.

3• Position the rear section of the Window Visor into the rubber window channel.

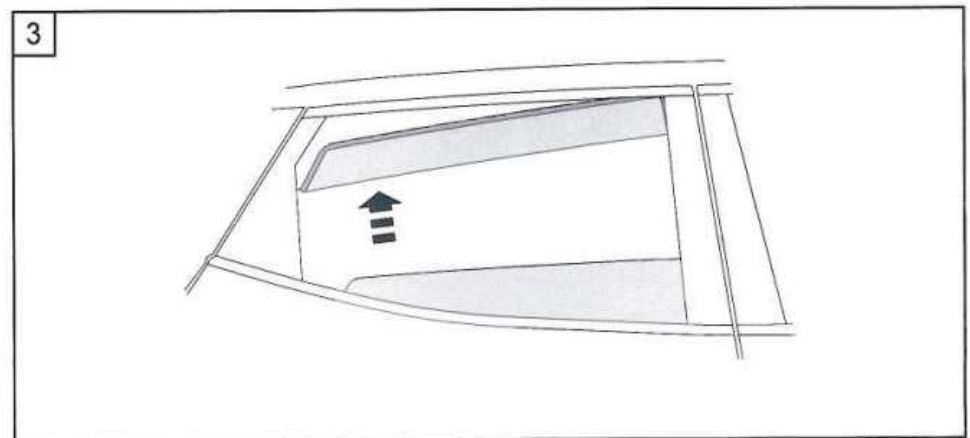
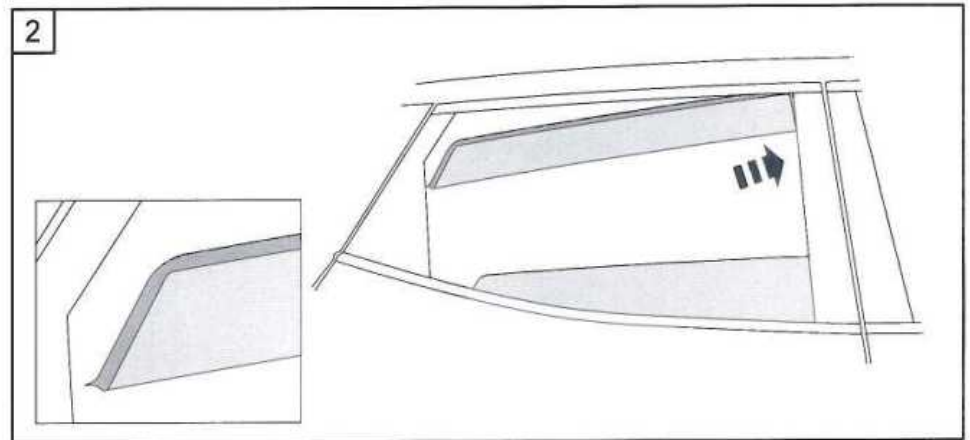
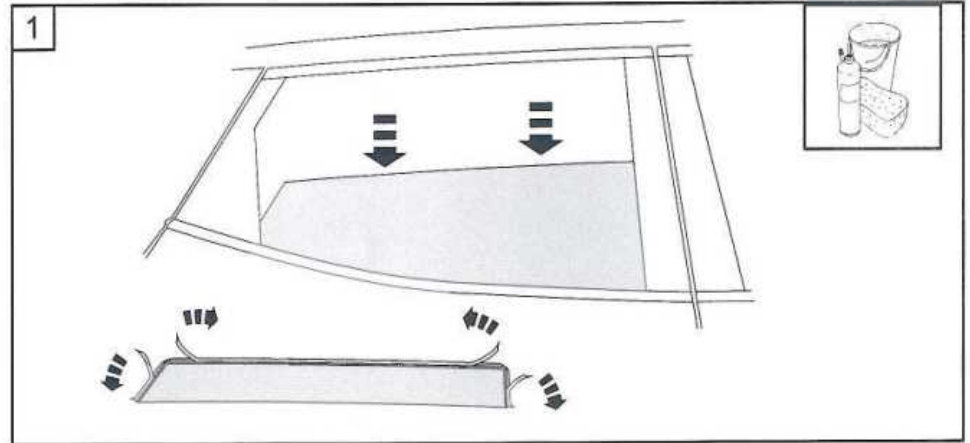



# EGR INSTALLATION INSTRUCTIONS

### Tools Required

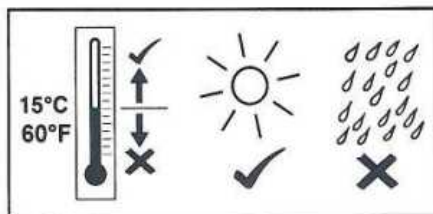

4• Work the Window Visor into the rubber window channel by hand, ensuring it locates securely.

5• Ensure the Window Visor is located in the outer most section of the rubber window channel. Pull the bottom of the Window Visor outwards at the rear of the part while raising and lowering the window a minimum of 5 times to help seat the Window Visor into the rubber window channel.

**IMPORTANT:** Before fitting product, read instruction fully. Full tape strength is achieved after 72hrs. Allow tape to cure for 4hrs before driving vehicle. Reverse the above procedure to remove this product.

#### To Clean:

- Use mild detergent and water solution
- Do not use solvents
- Avoid the use of automatic "Brush Style" car washes.
- When closing the hood, do not pull on Hood Protector.

