



EDELBROCK NITROUS SYSTEMS

PERFORMER RPM SERIES NITROUS SYSTEM INSTALLATION AND OPERATION INSTRUCTIONS

This instruction manual supports the following Kit Part Numbers:
Performer RPM Nitrous Systems #70050, #70051, and #70053



Edelbrock Nitrous Systems
2700 California Street
Torrance, California 90503
Tech Line (800) 416-8628
Tech Fax (310) 970-2730

Rev. 12/00

Thank You....

...for purchasing an Edelbrock Nitrous Oxide Injection System.

Nitrous Oxide injection is one of the most exciting performance enhancements for the dollar invested on the market today. With the use of nitrous oxide come some important safety considerations. This manual has been written to help you during the installation and use of your Edelbrock Nitrous System. Please read it completely before you install and use your system. Please pay close attention to the safety information at the beginning of each section. The information contained there specifically pertains to each of the components and installation methodologies within the section.

Please take the time to read and understand the following....

By installing your Edelbrock Nitrous System, you indicate you have read this document and you agree with the terms stated below.

It is the responsibility of the purchaser to follow all installation instruction guidelines and safety procedures supplied with the Edelbrock Nitrous Systems. It is also the responsibility of the purchaser to determine the compatibility of the product with the vehicle or the device on which the purchaser intends to install it.

Edelbrock Corporation assumes no responsibility for damages occurring from misuse, abuse, improper installation, improper operation, lack of responsible care, or all previously stated reasons resulting from incompatibility with other manufacturers products and/or systems.

Edelbrock Corporation neither recommends nor condones the use of products manufactured or sold by Edelbrock Corporation for use on vehicles, which may be driven on public roads or highways, and assumes no responsibility for damages incurred by such use.

Edelbrock Corporation assumes no responsibility for damages incurred by the use of products manufactured or sold by Edelbrock Nitrous Systems on vehicles used for competition or racing.

Edelbrock General Warranty

It is the constant endeavor of Edelbrock Corporation to give our customers the highest quality products obtainable. Edelbrock warrants each new product, except Performer Series Carburetors, Race Division Parts, Tubular Exhaust Systems, RPM Series Mufflers, Cat-Back Systems and Performer IAS Shock Absorbers which are warranted separately, to be free from defects in both workmanship and material for a period of one (1) year from the date of purchase, provided that the product is properly installed, subjected to normal use and service and that the product is not modified or changed in any way, negligence by customer or installer or used for racing or competition purposes.

Our warranty service and repair facility is located at 2700 California Street, Torrance, California 90503. Customers who believe they have a defective product should either return it to the dealer from which it was purchased or ship it directly to Edelbrock along with proof of purchase and a complete description of the problem. The product must be returned freight pre-paid. If a thorough inspection of the product by the factory indicates defects in workmanship or material, our sole obligation shall be to repair or replace the product. Warranty covers only the product itself and not the cost of installation or removal.

Edelbrock Corporation shall not be liable for any and all consequential damages occasioned by the breach of any written or implied warranty pertaining to this sale in excess of the purchase price of the product sold.

If you have any questions regarding a product or installation, please contact our Technical Department, toll free at 1-800-416-8628 from 7:00am to 5:00pm PST, Monday through Friday.

Thank you again for choosing Edelbrock Nitrous Systems.



EDELBROCK NITROUS SYSTEMS

PERFORMER RPM SERIES NITROUS SYSTEM

Table of Contents

| | | |
|------------|--|-------|
| a. | Before You Install Your Edelbrock Nitrous System | pg 2 |
| b. | What is Nitrous Oxide? | pg 3 |
| c. | Safety Tips for Working with Nitrous Oxide | pg 3 |
| 1.0 | Introduction to the Edelbrock Nitrous Systems Kit | |
| 1.1 | General Information | pg 4 |
| 1.2 | Jet Map Information | pg 5 |
| 1.3 | Engine Operation Considerations | pg 6 |
| 1.4 | Performer RPM Kit Bill of Materials | pg 7 |
| 2.0 | Performer RPM System Installation | |
| 2.1 | Nitrous Bottle Mounting | pg 9 |
| 2.2 | Bottle Mounting Instructions | pg 10 |
| 2.3 | Bottle Orientation | pg 10 |
| 2.4 | Bottle Installation | pg 11 |
| 2.5 | Nitrous Feed Line Mounting | pg 12 |
| 2.6 | Solenoid Mounting | pg 12 |
| 2.7 | Nitrous Solenoid Mounting and Installation | pg 13 |
| 2.8 | Fuel Solenoid Mounting and Installation | pg 13 |
| 2.9 | Nitrous/Fuel Solenoid Disassembly and Inspection | pg 14 |
| 2.10 | Nitrous Injection Plate Installation | pg 15 |
| 2.11 | Solenoid/Plate Plumbing Installation | pg 15 |
| 2.12 | Electrical System Installation | pg 16 |
| 2.13 | Relay and Fuse Holder Installation | pg 17 |
| 2.14 | Arming Switch | pg 19 |
| 2.15 | Microswitch Installation and Wiring | pg 19 |
| 2.16 | Final Electrical Installation Recommendations | pg 20 |
| 3.0 | Before You Run Your Vehicle With Nitrous | pg 21 |
| 4.0 | Baseline Tuning Suggestions. | pg 22 |
| 5.0 | Ignition Timing and Nitrous Oxide. | pg 23 |
| 6.0 | Troubleshooting and Routine Maintenance | pg 25 |



Caution!!

Before You Install Your Edelbrock Nitrous System...

Please read this Installation manual fully before installing this system.

You will need to have available the following tools:

Hand Tools

- Socket set including ratchets and extensions
- Screwdrivers
- Pliers
- Bench vise
- Wire crimping pliers, wire strippers
- Floor jack
- Vehicle jack stands
- Measuring tape and placement markers
- Timing light
- Fuel pressure measurement gauge
- Safety glasses

Power Tools

- Power drill
- Drill bits

You should understand the following skills:

- Power tool safety procedures
- Undercar safety procedures
- Proper measuring techniques
- Proper electrical assembly techniques
- Basic engine operation and tuning techniques which include:
 - Fuel pressure measurement techniques
 - Timing adjustment techniques



Anytime you have questions or concerns with your Edelbrock Nitrous System, please call our technical support hotline at 1-800-416-8628 before you start your engine.

WHAT IS NITROUS OXIDE?

Nitrous Oxide is a cryogenic gas composed of nitrogen and oxygen molecules. It is stored as a “gas over a liquid” which means that both liquid and gaseous nitrous oxide is delivered into your engine. It is 36% oxygen by weight, which is what produces the added horsepower. By injecting more oxygen (and a corresponding fuel signal), we create the additional power the same way a supercharger or a turbocharger does.

Nitrous Oxide is considered an “oxidizer” and not a fuel. Therefore, nitrous oxide is non-flammable by itself. Because nitrous oxide is a cryogenic, the same safety methods in handling dry ice apply to nitrous. Direct contact with the skin will cause a burn similar to contact with dry ice. The exception in using nitrous oxide comes from increased breathing hazards associated with the gaseous properties of nitrous oxide.

Nitrous Oxide is offered for sale in two common grades, which are U.S.P., and *Nytrous Plus* U.S.P. nitrous oxide is medical grade nitrous oxide. Its common use is dental and veterinary anesthesia as well as use as a propellant in food such as canned whip cream. U.S.P. is not available to the public and would provide no advantage in the making of horsepower over the automotive grade nitrous oxide.

Nytrous Plus was specifically designed for automotive consumption and differs from U.S.P. in that it contains trace amounts of sulfur dioxide (100 parts per million or “PPM”) added to prevent substance abuse. The Sulfur Dioxide is an irritant to all of your breathing passageways and will create sore throats and sore nasal passages. *Nytrous Plus* was specifically created for automotive applications and is available for sale to the public at many speed shops across the USA.

Safety Steps For Working With Nitrous Oxide

1. **Never** inhale *Nytrous Plus* (Nitrous oxide (N₂O) for vehicular use) as continued exposure can cause death. *Nytrous Plus* has a maximum of 100 parts per million (ppm) of sulfur dioxide and will cause irritation to nose and throat passageways.
2. When working around any high-pressure gas including nitrous oxide, take all precautions to ensure that exposure to nitrous oxide is minimized.
3. **Do not** vent nitrous oxide to atmosphere in confined spaces. Only vent nitrous oxide in well-ventilated and open areas.
4. Liquid nitrous oxide can cause burns to human flesh so protect all skin in and around your hands, arms and face. Wear safety glasses and rubber gloves to protect from liquid nitrous oxide splatter.
5. When venting down the nitrous system, vent the line down closest to the nitrous bottle.
6. **Do not** use any form of Teflon tape as sealant on fitting connections. Use only Teflon paste.
7. When washing components, ensure the clean components are completely dry, free of oils, and solvents. Failure to remove all liquids could cause component or system failure.
8. **Always** turn the bottle off before making any repairs to the nitrous delivery system.
9. To safely release nitrous oxide in a pressurized line;
 - a. Position vehicle in a well-ventilated, unconfined space.
 - b. Turn bottle off.
 - c. Slowly turn the nitrous feed line at the bottle open until you hear a light hissing noise.
 - d. Allow the entire nitrous pressure to vent from the line.
 - e. Perform your work on the system.
 - f. Re-attach the nitrous line to the bottle.
 - g. Slowly open the nitrous bottle valve, listening for leaks.
 - h. Perform leak checks on all affected fittings and the bottle fitting.



Anytime you have questions or concerns with your Edelbrock Nitrous System, please call our technical support hotline at 1-800-416-8628 before you start your engine.

1.0 Introduction To Your Edelbrock Performer RPM Nitrous Oxide System

....about this manual!

Within the pages of this manual is information, safety tips and operation instructions for your new Edelbrock Nitrous System. Watch for these symbols to know where to go for information....



.....there is safety related information listed here.



....shows where technical information about your specific vehicle or specific skills will help during the installation.



.....call Edelbrock for more information.

1.1 General information

The Edelbrock Performer RPM Nitrous Systems are intended for use on domestic style V-6 and V-8 engines using single square-flange 4 bbl. carburetors (Part Number 70050), spread-bore 4 bbl. carburetors (Part number 70051), and Dominator-flange carburetors (Part Number 70053). Horsepower and torque increases can vary with engine displacement and equipment upgrades and modifications. Approximate power increase estimates can be made based on the mass flow of nitrous oxide into the engine.

These types of systems utilize an adjustable plate that sandwiches in between the carburetor and the carburetor mounting pad on the intake manifold. The adjustability comes from the ability of the plate to accept different orifice-sized jets. The plate has jet fittings at opposite ends of the plate that control the amount of nitrous oxide and fuel flow into the engine.

This system has been designed with flexibility as to where certain components can be located within the engine compartment. The electrical components have properly-sized and ample lengths of wire for some flexibility on where voltage signals are intercepted on the electrical system.

The solenoid and microswitch brackets have a universal shape to allow for adjustability in placement and location of these components. The solenoids have ample feed line lengths for many different manifold, air cleaner, carburetor configurations and the microswitch bracket will allow for several different positions.

This system includes the bottle, bottle feed line and universal footprint steel bottle brackets. The mounting brackets also include rubber insulators to protect the surface of your nitrous bottle while in the brackets. When installing your nitrous bottle, pay close attention to the installation instruction for the location of your bottle. Ensuring the installation of your bottle does not compromise systems that may lie under the potential location where you plan to drill mounting holes.

Call your local automotive store, motorcycle shop and race track for refilling of your bottle. Trust a professional to properly fill your bottle and reference this manual when re-installing your new filled bottle back into your vehicle.

Always take care when handling a full bottle of nitrous oxide. Please reference this manual for further safety measures to take during the handling of a nitrous oxide bottle.

Please follow all safety methods during the installation of your Edelbrock Nitrous System, and follow all vehicle regulations and road laws when using your nitrous system.

1.2 Jet Map Information

Edelbrock engineering has conducted dyno testing with the Performer RPM system to provide jetting maps for the three separate plates at different jetting levels. These jet combinations are supplied with this system kit to enable you to vary your engine's power output. On a typical mildly-modified 350 cubic-inch engine, you can expect the following approximate power gains for each of the jetting levels:

Square-Flange Jet Map

| Nitrous/Fuel Jetting | Approx. HP Gains | Final Air/Fuel Ratio | Timing Adj. | Footnotes |
|----------------------|------------------|----------------------|----------------|-----------|
| 55/61 | 100hp | 11.0:1 | 32 Deg. Total. | ①③ |
| 71/75 | 150hp | 11.0:1 | 30 Deg. Total. | ①③ |
| 78/82 | 175hp | 11.0:1 | 30 Deg. Total. | ①③ |
| 85/89 | 200hp | 11.0:1 | 28 Deg. Total. | ②④⑤ |
| 99/102 | 250hp | 11.0:1 | 26 Deg. Total. | ②④⑤ |

Spread-Bore Jet Map

| Nitrous/Fuel Jetting | Approx. HP Gains | Final Air/Fuel Ratio | Timing Adj. | Footnotes |
|----------------------|------------------|----------------------|----------------|-----------|
| 59/62 | 100hp | 10.8:1 | 32 Deg. Total. | ①③ |
| 71/75 | 150hp | 10.5:1 | 30 Deg. Total. | ①③ |
| 81/86 | 175hp | 10.2:1 | 30 Deg. Total. | ②③ |

Dominator-Flange Jet Map

| Nitrous/Fuel Jetting | Approx. HP Gains | Final Air/Fuel Ratio | Timing Adj. | Footnotes |
|----------------------|------------------|----------------------|----------------|-----------|
| 57/63 | 100hp | 11.0:1 | 32 Deg. Total. | ①③ |
| 71/75 | 150hp | 11.0:1 | 30 Deg. Total. | ①③ |
| 85/89 | 200hp | 11.0:1 | 28 Deg. Total. | ②④⑤ |
| 104/108 | 250hp | 11.0:1 | 26 Deg. Total. | ②④⑤ |

The dyno tests were conducted at Edelbrock using a mildly-modified 350 cubic-inch engine. Both dual-plane and open-plenum intake manifolds were tested to ensure validity of jetting maps for each horsepower setting. Modifications included Edelbrock intake manifolds, Edelbrock aluminum heads, dyno headers, and improved ignition. We also used different grades of fuel and colder plugs during the testing. All stated timing adjustments listed in jet maps is where the motor being tested worked best. Final timing should be adjusted to achieve best power and/or MPH per application. See section "5.0 Ignition Timing and Nitrous" for more info on timing selection.

These jetting patterns are designed to be rich and will provide the above-listed power settings under normal operational usage of this system. Any variation in jetting patterns other than what is listed above and engine damage could occur. Please contact the Edelbrock Technical Department with any questions you have concerning jetting patterns and their effects on engine performance.

Jet Map Footnotes

The jet map above has footnotes that offer the following instructions and technical information.

- ① Spark Plugs use Champion RC-12-YC or equivalent.
- ② Spark Plugs use Champion C-614-C or equivalent.
- ③ Fuel use 92 octane pump gasoline or better.
- ④ Fuel use 110 octane race gasoline or better.
- ⑤ Single Plane manifold only. **DO NOT** use a dual plane manifold at this horsepower level.

Italics...

The last two horsepower settings (200 and 250) are for single plane manifolds only. In testing, we found that dual plane manifolds have some distribution problems at these super high flowrates that could cause engine damage. Please contact the Edelbrock Technical department with any questions you have concerning jetting patterns and their effects on engine performance when using a dual plane manifold.

1.3 Engine Operation Considerations

When used correctly, nitrous oxide safely elevates cylinder pressures and temperatures while increasing combustion rate. These characteristics make the engine more sensitive to detonation. To ensure proper performance and engine life, the following tips are suggested:

- **Adequate Fuel Pressure and Delivery**

When designing your fuel system, plan on your pumps and lines flowing at least 0.1 gallons per hour per horsepower at rated pressure. The testing at Edelbrock was conducted with a fuel pressure of 6.5 to 7 psi. Any variation from this fuel pressure will cause your final air/fuel ratio to change. Consult our technical department for any questions on fuel pressure and its effects on final air/fuel ratios when using nitrous oxide.

- **Performer RPM Fuel System Requirements**

When using the Performer RPM series kits, the potential horsepower gains are quite high. The critical area for continued success with your nitrous system lies in the fuel system. In most cases, an auxiliary fuel supply system will be a required addition to your nitrous system. A high flow electric fuel pump and high capacity adjustable fuel pressure regulator are both recommended to ensure the fuel flow rate is enough to ensure proper system operation. The minimum size we recommend for the fuel inlet feed line is a -6 (3/8" inch), with a size of -8 (1/2" inch) recommended for the higher horsepower settings.

- **Performer RPM System Monitoring Requirements**

Fuel pressure and nitrous pressure gauges are very important. Your fuel pressure must be set properly and a gauge is the only sure way to monitor system performance. The same is true of the nitrous bottle pressure. A nitrous pressure gauge is the only way to ensure that your system calibrations are within the parameters required of your horsepower setting.

- **Fuel Quality**

Because nitrous oxide is an oxidizer, fuel selection is critical. Both octane and fuel consistency affect fuel burn rate. The oxidizer quality of nitrous oxide will accelerate the burn rate, so we recommend a high quality of gasoline. We also recommend you use the same grade of gasoline every time you use your nitrous oxide system. This will maintain the same fuel burn rate every time. Please refer to the jet map footnotes for information on what fuel types and fuel qualities that were used during the testing here at Edelbrock.

- **Engine System Upgrades**

With all performance modifications complementary system upgrades will always serve to elevate the consistency and longevity of an engine, especially when using nitrous oxide as a power adder. Ignition upgrades, intake manifold upgrades, and fuel controls and fuel pumps can all add to the performance of a nitrous oxide injected engine.

- **Cast Pistons**

With all nitrous oxide applications, forged pistons are highly recommended. Because of heightened potential for detonation, cast pistons are more prone to failure and cannot handle horsepower increases over 125 hp. Never initiate your nitrous system before you are at full-load, wide-open throttle conditions. Cast pistons will not be able to survive this kind of stress.



Anytime you have questions or concerns with your Edelbrock Nitrous System, please call our technical support hotline at 1-800-416-8628 before you start your engine.

1.4 Performer RPM System Bill of Materials (BOM)



| Item | Quantity | Description |
|---|----------|--|
| <u>Plates and Plate Hardware</u> | | |
| 1 | 1 ea | Performer RPM Square-flange Plate, 70050 System |
| 1a | 1 ea | Performer RPM Spread-bore Plate, 70051 System |
| 1b | 1 ea | Performer RPM Dominator Plate, 70053 System |
| 2 | 2 ea | Square-flange gaskets, 70050 System |
| 2a | 2 ea | Spread-bore gaskets, 70051 System |
| 2b | 2 ea | Dominator gaskets, 70053 System |
| 3 | 4 ea | Long Carb Studs, 70050 System |
| 3a | 4 ea | 2 ea Long Carb Studs, 2 ea Long Carb Bolts, 70051 System |
| 3b | 4 ea | Long Carb Studs, 70053 System |
| <u>Solenoids and Solenoid Hardware</u> | | |
| 4 | 1 ea | Performer RPM Nitrous Solenoid (Black) |
| 5 | 1 ea | Performer RPM Fuel Solenoid (Red) |
| 6 | 2 ea | Solenoid Brackets with Screws (4 ea) |
| 7 | 1 ea | 12" Nitrous Feed Line (Blue), Solenoid to Plate |
| 8 | 1 ea | 8" Fuel Feed Line (Red), Solenoid to Plate |
| <u>Fittings</u> | | |
| 9 | 1 ea | N2O Filter Fitting, 4AN x 1/8" NPT, Blue |
| 10 | 1 ea | 6AN x 1/4" NPT Fuel Fitting, Red |
| 11 | 1 ea | 4 AN x 1/8" NPT Nitrous Fitting, Blue |
| 12 | 1 ea | 4AN x 1/8" NPT Fuel Fitting, Red |
| <u>Bottle and Bottle Hardware</u> | | |
| 13 | 1 ea | 10 lb. Nitrous Bottle |
| 14 | 1 pr | Nitrous Bottle Bracket Set, (1 Tall, 1 Short) |
| 15 | 1 ea | 660 Bottle Nut and Teflon Washer |
| 16 | 1 ea | 14' Nitrous feed Line, bottle to solenoid |
| <u>Electrical System Components</u> | | |
| 17 | 1 ea | Electrical Component Package (see page 16 for BOM) |
| <u>Technical Information</u> | | |
| 18 | 1 ea | Performer System Information Packet |

1.4 Performer RPM System Bill of Materials (Continuation)

Jets

Performer RPM Square-Flange Jet Pack P/N 70050

| | | |
|----|-------|-----------|
| 19 | 1 ea. | Jet, #55 |
| 20 | 1 ea. | Jet, #61 |
| 21 | 1 ea. | Jet, #71 |
| 22 | 1 ea. | Jet, #75 |
| 23 | 1 ea. | Jet, #78 |
| 24 | 1 ea. | Jet, #82 |
| 25 | 1 ea. | Jet, #85 |
| 26 | 1 ea. | Jet, #89 |
| 27 | 1 ea. | Jet, #99 |
| 28 | 1 ea. | Jet, #102 |

Performer RPM Spread-Bore Jet Pack P/N 70051

| | | |
|-----|-------|----------|
| 19a | 1 ea. | Jet, #59 |
| 20a | 1 ea. | Jet, #62 |
| 21a | 1 ea. | Jet, #71 |
| 22a | 1 ea. | Jet, #75 |
| 23a | 1 ea. | Jet, #81 |
| 24a | 1 ea. | Jet, #86 |

Performer RPM Square-Flange Jet Pack P/N 70053

| | | |
|-----|-------|-----------|
| 19b | 1 ea. | Jet, #57 |
| 20b | 1 ea. | Jet, #63 |
| 21b | 1 ea. | Jet, #71 |
| 22b | 1 ea. | Jet, #75 |
| 23b | 1 ea. | Jet, #85 |
| 24b | 1 ea. | Jet, #89 |
| 25b | 1 ea. | Jet, #104 |
| 26b | 1 ea. | Jet, #108 |

2.0 Performer RPM System Installations

2.1 Nitrous Bottle Mounting

The nitrous oxide storage cylinder is typically called a “nitrous bottle”. The “bottle” is not unlike a scuba tank. It is an aluminum cylinder, designed and manufactured to withstand very high pressures. The valve on top of the bottle is a high-flow design that allows easy opening and close which controls the nitrous flow to the engine compartment.

Accurate calibration of your nitrous system depends on the bottle remaining at a stable temperature. In vehicles (such as Corvettes) where the bottle must be mounted in an area subject to direct sunlight, it is suggested that the bottle be shielded with a bottle blanket.

If the bottle is mounted inside the passenger compartment or in a space that has access to the passenger compartment such as hatchbacks or vehicles that feature fold down rear seats, the pressure relief device (PRD valve) must be vented externally from the cockpit. This procedure will prevent the passenger compartment from filling with a cloud of nitrous oxide, should the safety pressure relief valve rupture.

Special consideration should be made to protect the bottle installation by not placing the bottle in a known crumple or crash zone within the vehicle. At no time should the bottle be mounted within the seating area of the passenger compartment of a street-driven vehicle.

Bottle Valve Handle Pictured

660 High Flow
Nitrous Exit



Pressure Relief
Device
(PRD)

The Performer RPM Bottle Valve installed on all the bottle valves used in Edelbrock Nitrous Systems is a Pressure Relief Device or “PRD”. It is a safety valve designed to vent the contents of the bottle into the atmosphere in case of a catastrophic event, such as a collision.

It also serves to prevent the over-pressurization of the bottle itself. Over pressurization can result from over-filling, exposure to direct sunlight, or high-temperatures. It can also come from a violent strike to the bottle surface.

It is illegal to tamper with, modify, or remove the PRD device.

Bottle Safety Information

1. **Do not** attempt to remove the bottle valve. Please return your bottle to Edelbrock if service is required to the siphon tube inside the bottle or the bottle valve itself.
2. **Never** heat the outside of your nitrous bottle with an open flame such as a torch.
3. **Do not** strike the surface of your nitrous bottle with a heavy or sharp object.
4. **Do not** drop your nitrous bottle.
5. **Do not** attempt to grind off or destroy any imprinted markings on the face of the bottle.
6. **Do not** remove, modify or otherwise tamper with the safety valve on the bottle valve.

Racing Vehicles

Before using the Edelbrock bottle mounting brackets to mount a nitrous bottle in a vehicle intended for use in racing or sanctioned events, check with the sanctioning association or local race track for any rules regarding bottle installation. Most associations require the bottle be mounted within the confines of the safety roll cage, with the safety pressure relief cap vented away from the driver’s compartment.

2.2 Bottle Mounting Instructions

Choosing the proper location and orientation for your bottle can greatly affect the overall operation of the nitrous system. Please read the entire bottle mounting instruction section before making your final bottle location decisions.

2.3 Bottle Orientation

Bottle placement is critical to the performance of your nitrous system. It is important to understand how the bottle valve and siphon tube are assembled to properly orient the bottle in your vehicle and ensure that it picks up liquid nitrous while undergoing acceleration. All nitrous bottles are assembled so that the bottom of the siphon tube is at the bottom of the bottle and opposite of the bottle label.

An Edelbrock nitrous bottle cannot be mounted upside-down. Edelbrock does not offer a non-siphon tube bottle for automotive use. If the bottle must be mounted parallel to the axles of the vehicle (sideways), the valve handle and label must be angled at approximately 45 degrees toward the front of the vehicle. This orientation will position the siphon tube toward the rear and pointing to the lower rear-facing quadrant of the bottle. All of this positioning information is critical to system operation. It is important to draw as much liquid nitrous as possible. The siphon tube cannot do this unless the bottle is positioned correctly.

The most efficient mounting is the lay-down position with the valve handle toward the front of the vehicle and the bottle label facing up. This position allows the greatest amount of liquid to be used before the siphon tube begins to pick up gaseous nitrous oxide.



The bottle in this location allows for access to other areas within the trunk, does not interfere with access to the spare tire, and is away from the very rear of the vehicle.

This bottle orientation also positions the end of the siphon tube for best liquid nitrous draw.

2.4 Bottle Installation

After you have determined the location and orientation of the nitrous bottle, use the following procedure to install the bottle:

2.4.1 Street Car Installations

1. Determine the location of the bottle within the confines of the rear of the vehicle.
2. Once a mounting location has been determined, raise the vehicle (following all safety practices involved in working on a vehicle from under the vehicle) and verify that there are no fuel lines, fuel tank(s), brake lines, emissions equipment, or structural members in the way of potential mounting bolt locations.
3. Using the mounting bracket bolt holes as templates, mark an area for each of the two (2) brackets with chalk, metal marking pen, scribe, or marking pen to locate the bolt placements for drilling.
4. Drill two (2) 3/8" mounting holes for each bracket.
5. Install the bottle mounting brackets using Grade 8 bolts, nuts and flat washers (not included with kit).
6. Tighten the mounting bolts using a thread locking chemical (not included with kit).
7. Install the rubber insulators within the bottle brackets.
8. Slip bottle into the mounting brackets.
9. Tighten bracket clamps as shown in the picture.



Shown here is a bottle with a bottle bracket properly installed with the rubber insulator. The distance between the bottle brackets is somewhat adjustable. Remember, mount the short bottle bracket at least 1" from the bottom of the bottle, and never cover any of the bottle label with a bottle bracket.

Do not attempt to install the bottle in the bracket without the rubber insulator. The bottle hoop on the bracket is designed to include the thickness of the insulator.

2.4.2 Race Car Nitrous Bottle Installations

Install the bottle brackets in accordance to race track and/or sanctioning body rules. Contact the factory for assistance with meeting sanctioning body rules.

2.4.3 Nitrous Bottle Installations For Vehicles With Hatchbacks Or Trunk Areas That Are Connected With The Passenger Compartment.

Please contact Edelbrock for more information.

2.5 Nitrous Feed Line Mounting

1. Determine the route your main nitrous feed line will follow. Ensure the path does not route the nitrous feed line too close to the exhaust system, suspension, electrical lines/components and tires.
2. Attach nitrous supply line to bottle.
3. Feed nitrous line along proposed route.
4. Secure nitrous supply line to underside of vehicle.
 - Note:** Stainless steel covering of the main nitrous feed line is very abrasive. Shield painted components or sensitive system components like electrical, fuel lines, brake lines or suspension components to prevent them from contacting main feed line. Rubber hose can be slid over and retained as a chafe guard.
5. Leave nitrous line loose pending installation of nitrous solenoid.

2.6 Solenoid Mounting

Use the following procedures to install the Performer RPM nitrous solenoid and fuel solenoid.

Note: Remember to use Teflon paste only on pipe threads. **Do not use Teflon tape.**

Hint: Placement of the solenoid is often limited by the lack of possible mounting locations in the engine compartment. However, if possible, observe the following suggestions:

Solenoid Safety Information

1. Keep solenoid and lines away from exhaust components.
2. Trial fit the solenoids with all lines attached to ensure a proper fit.
3. Solenoids may be mounted sideways or upside-down, if necessary.

2.6.1 Preparing To Mount Your Solenoids

1. Locate the universal solenoid brackets and solenoid mounting screws.
2. These solenoid brackets can be modified to clear almost any potential interference around the carburetor/plate mounting surface. Please look at the pictures or potential solenoid mounting locations and adapt your brackets according to the needs of your particular application.

Pictured here is an unmodified Performer RPM solenoid bracket with a modified bracket with solenoid attached, ready for installation on an intake manifold.

The modifications can be performed by clamping the solenoid bracket in a bench vise, or by using wide jaw pliers.



2.7 Nitrous Solenoid Mounting and Installation

1. Hold the nitrous solenoid securely (like in a bench vise) being careful not to harm the solenoid or block the inlet or outlet of the solenoid.
2. Install nitrous filter fitting (Blue fitting 4AN X 1/4 NPT) using liquid Teflon in the inlet port of the nitrous solenoid.
3. Install 4AN x 1/8 NPT (Blue straight fitting) using liquid Teflon in the outlet port of the nitrous solenoid.
 - i. Remove nitrous solenoid assembly from vise.
 - ii Attach solenoid-mounting bracket to the bottom of nitrous solenoid.
 - iii. Verify desired mounting location for nitrous solenoid.
4. Install nitrous solenoid. If solenoid-mounting location is difficult to access, leave solenoid loose so the solenoid inlet and outlet port can be easily accessed.
5. Leave wires loose for electrical system installation.
6. Attach nitrous feed line to solenoid. (blue fitting 4AN x 1/4 NPT).

Pictured here is the Performer RPM solenoid mounted on an Edelbrock intake manifold using a modified solenoid bracket. The modifications performed to a solenoid bracket depend on many factors. The considerations of solenoid placement are the same for both Nitrous and Fuel. The modifications to the solenoid bracket pictured is just an example. The modifications for all system brackets will be different per your application.

The line length between the Performer RPM fuel solenoid and the jet fitting on the injection plate is 8 inches. The line length between the Performer RPM nitrous solenoid and the jet fitting on the injection plate is 12 inches. Other factors or components that could potentially interfere with solenoid placement are:

- * Water neck/thermostat housings
- * Water fittings
- * Distributor housings
- * Vacuum advance canisters
- * Air filter housings
- * Throttle linkage passageways
- * Valve covers and valve cover fasteners



2.8 Fuel Solenoid Mounting and Installation

1. Hold the fuel solenoid securely (like in a bench vise) being careful not to harm the solenoid or block the inlet or outlet of the solenoid.
2. Install 6AN x 1/4 NPT fuel inlet fitting using liquid Teflon in the inlet port of the fuel solenoid.
3. Install 4AN x 1/8 NPT (Red straight fitting) using liquid Teflon in the outlet port of the nitrous solenoid.
4. Remove fuel solenoid assembly from vise.
5. Attach the universal solenoid-mounting bracket to the bottom of nitrous solenoid.
6. Verify desired mounting location for nitrous solenoid.
7. Install fuel solenoid. If solenoid-mounting location is difficult to access, leave solenoid loose so the solenoid inlet and outlet port can be easily accessed.
8. Leave wires loose for electrical system installation.

2.9 Nitrous/Fuel Solenoid Disassembly and Inspection

1. Close valve on nitrous bottle.
2. Empty main nitrous supply line.
3. Remove solenoid from the engine and securely clamp it into a vise, taking great care not to damage the solenoid.
4. Remove the solenoid cover-retaining nut from top of the nitrous solenoid.
5. Remove coil and housing from nitrous solenoid base.
6. Unscrew stem from nitrous solenoid base. Do this by using a solenoid stem removal tool or by "double nutting" the stem and unscrewing the stem from the housing body. **Do not** use pliers on solenoid stem; damage to the stem will result.
7. Remove the stem, spring and plunger from the solenoid base paying close attention to the way they are assembled.
8. Examine the plunger seal for swelling, cuts and abrasions. The seal surface should be flat, except for a small circular indentation in the center of the seal.

Note: *A seal that has been contaminated or over-pressurized will bulge from exposure to chemicals other than fuel or nitrous oxide. It can appear to extend down from the plunger and be dome-shaped. A contaminated seal may return to its original shape if left out in fresh air for approximately 48 hours. It may then be returned to service. If it does not return to its original shape, it must be replaced.*

9. Clean the solenoid body. **Do not** use an oil-based solvent to clean any part of the solenoid. Remove all foreign matter and dirt. Make sure solenoid body is clean, dry and free of oils before assembly.
10. Replace the O-Ring, plunger and piston spring.
11. Re-assemble solenoid by reversing disassembly procedure.

2.10 Nitrous Injection Plate installation

The Edelbrock Nitrous System injection plate is a precision-designed CNC-machined component. It has been designed to safely introduce a precise, metered nitrous and fuel signal to promote proper mixing and distribution into the intake manifold. The jet map on page 5 will give you the proper jets to use for each of the power levels available for this plate.

The jet fittings are color-coded for use with nitrous (*blue*) and fuel (*red*). The red fitting faces the front of the engine and the blue fitting faces the rear. The plate has been etched indicating which of the gasket surfaces face upward. Look at the brass tubes, a properly oriented plate will have the nitrous tube above the fuel tube ensuring the angled orifices machined into the tube face orient to the floor of the intake manifold.

Use the following procedures to install injector plate:

1. Remove carburetor air cleaner.
2. Mark all vacuum lines and external connections attached to carburetor and disconnect them.
3. Disconnect throttle linkage from carburetor.
4. Disconnect fuel line from carburetor.
5. Remove carburetor.
6. Remove stock carburetor studs and clean mounting surface.
7. Install extended carburetor studs supplied with kit. (70050, 70053 Systems)
 - 7a. Install extended carburetor studs in front of manifold, and use extended bolts when re-attaching carburetor on the rear of carburetor. (70051 system)
8. Install injector plate and gaskets supplied on intake manifold.
9. Install carburetor.
10. Re-connect linkage, all external vacuum lines and fuel line.

Note: Every precaution has been taken to ensure the cleanliness of our components during the assembly of your Edelbrock Nitrous System. However, because of the importance of the jets and their calibration, extra care should be taken before you install your jets. Wash them thoroughly with carburetor cleaner or another non-oil based cleaner, before installing them into the plate.

2.11 Solenoid/Plate Plumbing Installation

1. Choose the final mounting location for your solenoids and mount them solidly.
2. Install desired nitrous and fuel jets in the jet fittings on the plate. Remember the red fitting is for fuel and the blue fitting is for nitrous. Mixing the jets up during installation can cause engine damage.
3. Using the braided-steel line that has the “red” ends, install the line on the “red” jet fitting on the plate and run the other end to the fuel solenoid. Make sure that you do not use any thread sealant on these types of fittings. Tighten both ends of the line.
4. Using the braided-steel line that has the “blue” ends, install the line on the “blue” jet fitting on the plate and run the other end to the nitrous solenoid. Make sure that you do not use any thread sealant on these types of fittings. Tighten both ends of the line.

2.12 Electrical System Installation

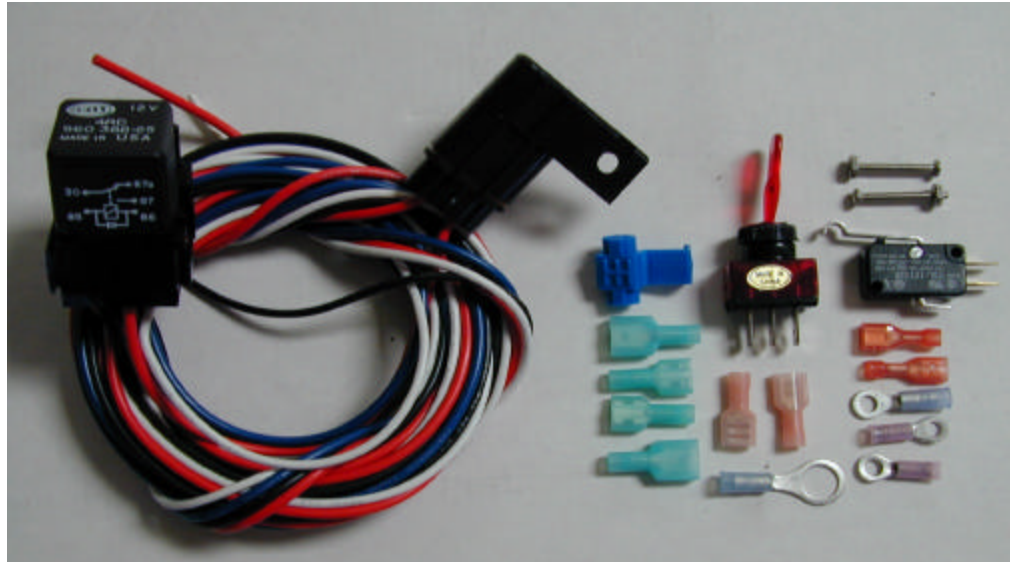

Electrical Components Bill of Materials (BOM)

| Item | Qty. | Description |
|------|-------|--|
| 1 | 1 ea. | Activation Microswitch |
| 2 | 1 ea. | Activation Microswitch bracket |
| 3 | 2 ea. | Activation Microswitch mounting nut (#4-40) |
| 4 | 2 ea. | Activation Microswitch mounting screw (#4-40x1") |
| 5 | 1 ea. | 30 amp relay |
| 6 | 1 ea. | Wire Harness w/integral Relay/Fuse holder |
| 7 | 1 ea. | Red-lighted toggle switch |
| 8 | 2 ea. | 18/22g ring terminal #10 stud, Nylon insulated |
| 9 | 1 ea. | 14/16g ring terminal #10 stud, Nylon insulated |
| 10 | 1 ea. | 14/16g male spade connector, Nylon insulated |
| 11 | 2 ea. | 14/16g female spade connector, Nylon insulated |
| 12 | 4 ea. | 18/22g female spade connector, Nylon insulated |
| 13 | 1 ea. | 15a ATO blade fuse |
| 14 | 1 ea. | 14/16g 3/8" ring terminal |
| 15 | 1 ea. | Nylon Splice, Insulation Displacement (16/18g) |

Nomenclature Descriptions.

ATO... the fuse configuration is ATO. When replacing this fuse, ask for an ATO fuse.

"a"... Amperage.

"g"... gauge of wire for that particular connector.

Important: The wiring hardware and instructions included with this kit are intended for 12-volt electrical systems only. Before attempting to wire your Edelbrock Performer nitrous oxide system, examine, and follow the above wiring diagram. Please call the Edelbrock technical department with any questions concerning electrical wiring at 1-800-416-8628.



When working with electrical systems in your vehicle, it is a good idea to have a service manual that features your vehicle. It is also good practice to have a book that specializes on the specialized techniques required when working with vehicular electrical systems.

2.12.1 Electrical System Installation Procedures

Determine the location of the Relay and Fuse Holder wire harness. Most common installations locate these components inside the driver's compartment and close to the fuse panel under the dash. You can also mount the Relay and Fuse Holder and harness close to the battery. However, these connectors are water-resistant, not waterproof, so care is required when mounting this assembly under the hood of your vehicle.

Wire Schematic Origin and Destination Map

| Wire Color | System | Origin | Destination | Terminal Used |
|------------|----------------------|---------------|-------------------|----------------------|
| Red | Bat Voltage | Relay Harness | Bat. Volt. Signal | Ring |
| Red | Arming Switch | Underdash | Switched 12v | Spade/Wire Intercept |
| Black | Relay Ground | Relay Harness | Chassis Ground | Ring |
| Black | Solenoid Ground | Solenoids | Chassis Ground | Ring |
| Black | Arming Switch Ground | Arming Switch | Chassis Ground | Ring |
| Blue | Solenoid Power | Relay Harness | Solenoids | Spade |
| White | Microswitch | Relay Harness | Microswitch | Spade |
| White | Microswitch | Arming Switch | Microswitch | Spade |

2.13 Relay and Fuse Holder Installation

The wire harness attached to the relay and fuse holder includes 8 feet of color-coded wires to make the electrical system installation for your Edelbrock Nitrous System as easy as possible. We recommend you do not cut any lengths of wires from the wire harness or complete the wiring of the nitrous system until all of the mechanical components are securely mounted in their permanent locations.

Once all of the solenoids and switches are placed, then route the un-cut wires from the harness to each location allowing enough wire length on each circuit to not interfere with operating linkages, heat sources, brackets, etc. Pay particular attention to sharp edges along the route of your wire harness, as they can chafe the wire and cause your system to fail.

After you have accounted for the routing of your wires, follow the Wire Harness Schematic on page 18, and use the Origin and Destination Map as a guide for which electrical connectors are used in each circuit.

Once you have determined the location of the relay and fuse holder, secure them with fasteners (not included with kit) such as sheet metal screws, bolts and nuts, etc. Allow for some slack in the red wire that connects the relay and fuse holders together.

When mounting your relay and fuse holder, make sure the mounting surface is strong enough to support servicing the relay and fuse. Also, ensure you allow for some slack in the wire that joins the fuse holder to the relay mount. This will avoid any potential loss of power due to stress on the wire harness.

The fuse is covered by the fuse mount housing.

The relay for the Performer RPM System is 30 amps. The fuse is 15 amps.

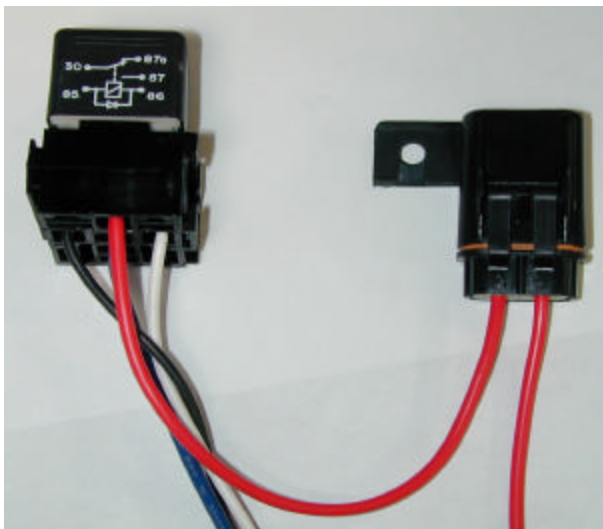

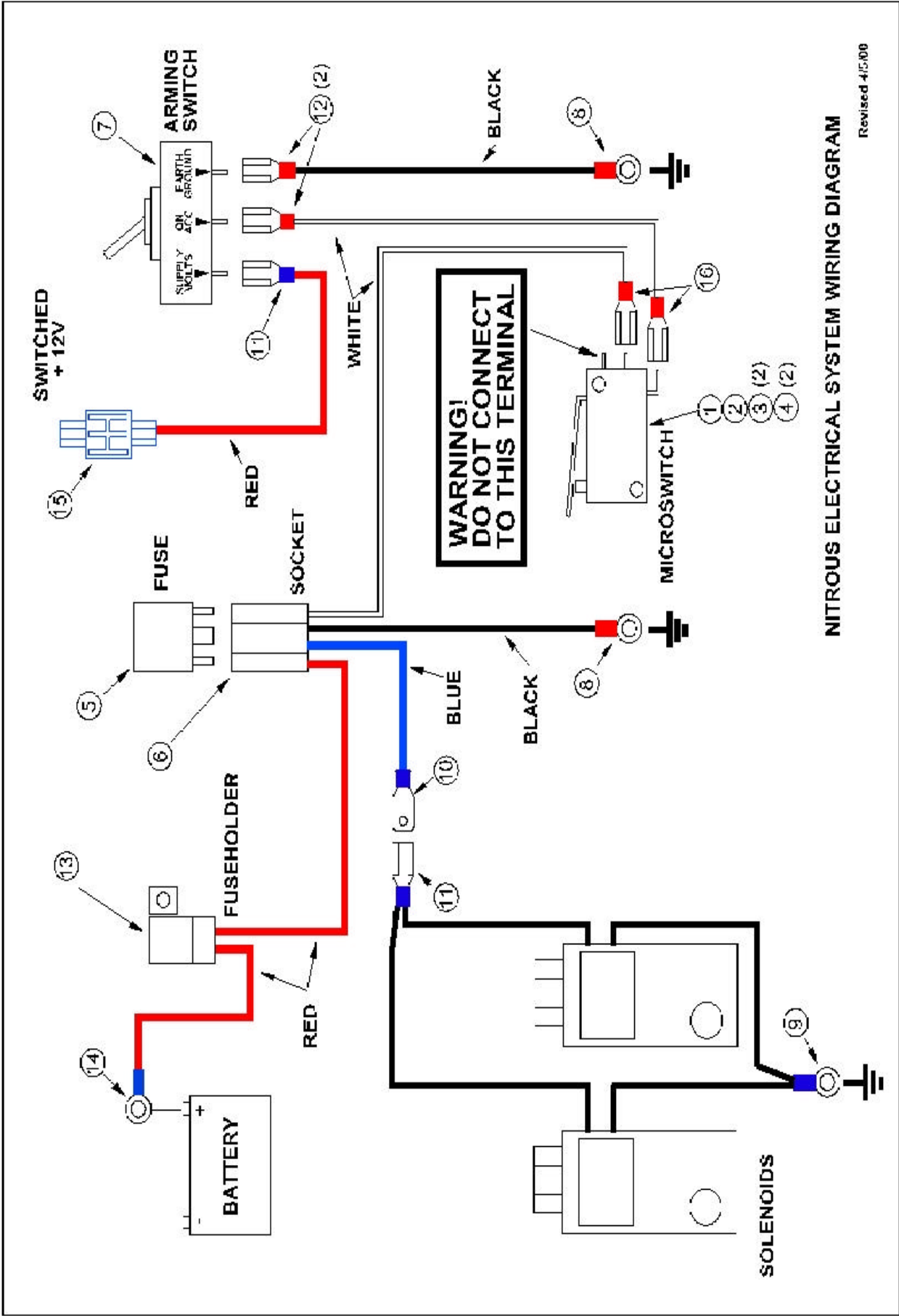

NITROUS ELECTRICAL SYSTEM WIRING DIAGRAM

Revised 4/5/00

2.14 Arming Switch

The arming switch is a red, lighted switch that is a “MASTER” arming switch for your nitrous system. Without it, your nitrous system would be “on” all of the time and capable of coming on anytime you go to wide-open throttle conditions. The switch when in the “armed” position is well lit, therefore it should be placed in an obvious position, well within the line of sight and easy reach of the driver.

2.14.1 Arming Switch Installation

1. Locate the final position of your arming switch.
2. Drill a .450” hole for the switch location.
3. Insert the switch from behind the mounting hole and secure with the switch nut.
4. Do not wire until all other mechanical components are in place. Please see the electrical system installation instructions for further information.

Note: There is a collar included with the switch for applications that require special spacing during installation.

2.15 Microswitch Installation and Wiring

The function of the microswitch is to enable your nitrous system. It should be installed so that the switch is forced closed by coming in contact with the carburetor linkage only at the wide open throttle position. The nitrous system must only function at fully-loaded wide-open throttle operating conditions.

Microswitch Safety Information

1. **Do not** allow wiring from the microswitch to come in contact with heat sources on the intake manifold such as EGR risers or passageways.
2. **Do not** run wires to the microswitch that can create interference with the operation of the carburetor linkage.
3. The microswitch must be located in such a way as to be clear of the normal operation of the carburetor linkage.
4. **Do not** directly expose the microswitch to liquids (water, gasoline).

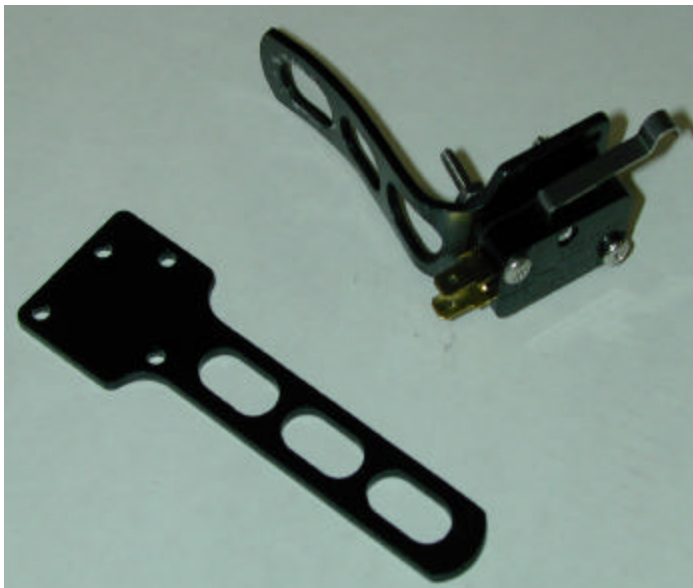

Pictured here is an unmodified microswitch bracket, and a “ready to install” microswitch assembly. The switch bracket has several mounting positions available for clocking of the switch. It also is of a universal length and can be attached to several positions on and around the carburetor linkage.

The bolts used to attach the microswitch have extra length to allow for spacing the microswitch away from the bracket to offer a level of adjustability of the microswitch. After determining the position of the microswitch, we recommend trimming the bolts for a clean installation.

2.15 Microswitch Installation and Wiring (cont.)

Pictured here is the microswitch assembly mounted for use with an Edelbrock Carburetor on an Edelbrock intake manifold. This is an example of one of the ways to mount a microswitch to your manifold. The microswitch bracket allows for many different mounting positions, to clear almost any potential interference around the carburetor/plate mounting surface.

Please look for potential microswitch mounting locations and adapt your microswitch bracket according to the needs of your particular application.



Due to the wide variety of carburetor and throttle linkage combinations in use, it is impossible to supply a microswitch bracket custom-tailored to each application. The universal bracket supplied will need to be modified to fit your specific application.

The microswitch bracket is drilled to permit many different switch mounting positions. This flexibility allows for the microswitch to be positioned in such a manner to engage the carburetor linkage without interfering with its normal and safe operation. The bracket may be manipulated (bent, twisted, and/or cut) to best suit your combination. Mount the microswitch on the carburetor so the actuation arm is triggered by throttle linkage making sure that all wiring and the bracket do not interfere with the smooth and safe operation of the carburetor.

Adjust the microswitch to ensure the actuation arm “clicks” at the same point your throttle linkage reaches wide open throttle against the throttle stop. At no time should the microswitch be enabled before wide open throttle.

2.16 Final Electrical Installation Recommendations

At this time, it is advised that you double check the following areas:

1. **Double check** all wires so that they do not come in contact with any heat sources like exhaust manifolds, and EGR crossovers, etc.
2. **Double check** the wires that lead from the microswitch to ensure they do not interfere with the operation of the carburetor linkage.
3. Make sure the relay and the fuse are serviceable and mounted securely.

You are ready to hook up your battery and prepare your vehicle to run.

3.0 Before You Run Your Vehicle Using Your Edelbrock Nitrous System

You have just completed the installation of your Edelbrock Nitrous System. It is time to perform some basic system checks to ensure all the work you have done is correct and ready to operate properly. The following procedure is designed to validate the operation of your nitrous system before operating your vehicle:



Note: Before performing steps 1 through 4, make sure the nitrous bottle is closed and main nitrous supply line is empty of any nitrous.

3.1 Fuel System Check

1. Hook up all battery leads.
2. Double-check all wires and leads for signs of heat and proper connections.
3. Start your vehicle.
4. Check all fuel lines and fitting for leaks.
5. Switch master (Red-lighted switch in drivers compartment) arming toggle switch to the "on" position. Raise engine speed to an above-idle RPM setting (example 2000 RPM). Briefly depress the activation arm on microswitch, which will open the fuel and nitrous solenoids. Listen for a loud click or hold the solenoids while you activate the microswitch. Engine speed should decrease if the fuel solenoid and delivery system is performing properly. If not, refer to "Troubleshooting Guide."

3.2 Nitrous System Check

1. Open nitrous bottle valve. (See note below).
2. Inspect nitrous lines and fittings for leaks using a soapy water mixture and a small brush.
3. If any of the fittings/connections show bubbling around the attachment nut or on the threaded area of the fitting, shut the nitrous bottle valve off immediately and dry the fitting before attempting any service to that particular fitting connection.
4. If the engine idle does not come up, and all of the fittings appear to be leak-free, you have successfully completed the installation of you Edelbrock Nitrous System.

Note: There should be no change in engine idle speed. If idle speed changes, close bottle valve. Your nitrous solenoid is probably open. Please refer the "Troubleshooting Guide" on page 25.

Pictured here is a fitting connection that was assembled using no thread sealant as a demonstration of what a leaking fitting can look like. As you can see, both fittings installed on the junction block are leaking high-pressure nitrous oxide.

Always use Teflon paste on all pipe fittings. **Never** use any kind of thread sealant on taper seal fittings like a jet fitting, or bottle line connections.

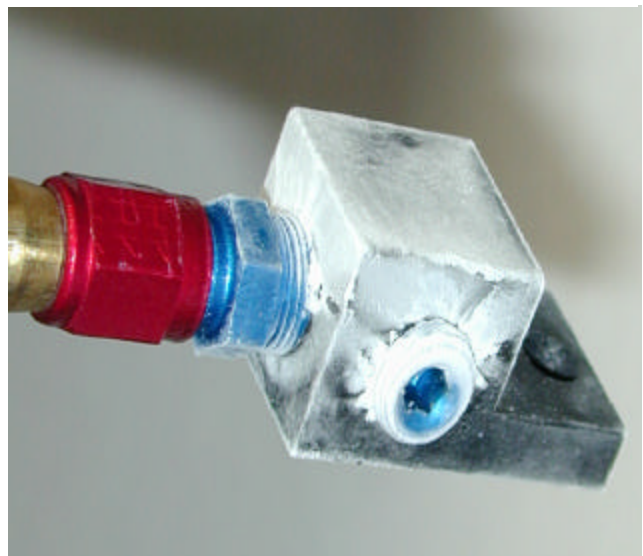

4.0 Baseline Tuning Suggestions

Utilizing nitrous oxide as a power adder is similar to a supercharger or a turbocharger in that it increases the amount of air an engine can get from atmospheric conditions. There are some significant differences:

1. The “air” in nitrous oxide is very oxygen rich. This oxygen is of a much higher density, so the opportunity to extract very high quotients of power is very high.
2. Nitrous oxide injection does not have a parasitic load factor associated with its use like a turbocharger or a supercharger. Meaning, it does not cost as much horsepower as a crank-driven supercharger or an exhaust-driven turbocharger.

The most important thing to remember when looking at baseline tuning issues associated with nitrous oxide is that a Nitrous “rich” condition is bad. Two parameters that will keep you from catastrophically affecting your engine are:

- 4.1 Nitrous Bottle Pressure...** Always keep your bottle pressure between 900 and 950 psi. Yes, there are racers that use different pressures, but the testing we did here at Edelbrock to ensure the jetting maps within this manual are correct, was done in this pressure range. Use any higher pressure than 950 psi and you will be nitrous “rich”. Use any pressures below 900 psi and you will be nitrous “lean”.
- 4.2 Fuel Pressure...** Always ensure you have between 6 and 7 psi of fuel pressure every time you enable your nitrous system. We used 6.5 to 7 psi of fuel pressure to perform our jet map testing on this system. If you do not have at least 6 psi of fuel pressure going to the fuel solenoid, when it is activated, you will be nitrous “rich”. If you were to have more than 7 psi of fuel pressure, when it is activated, to the fuel solenoid, you would be nitrous “lean”.

The jet map provided for your Performer RPM nitrous system is purposely “rich”, or biased to the fuel side of the nitrous to fuel ratio. There are many different ways to jet to a specific power level. However, for the continued safe operation of your nitrous system, we suggest you do not move too far away from the jet map listed within this manual. Catastrophic engine failure could result.

Your Performer RPM nitrous system comes with matched sets of nitrous and fuel jets. These are conservative jetting combinations, based upon 900 to 950 psi nitrous oxide bottle pressure, and 6.5 to 7 psi flowing fuel pressure. Operating with these pressure levels should yield safe and reliable power increases.

How To Read Spark Plugs From A Nitrous Oxide Injected Engine...

Spark plugs are a window into the combustion chamber. They will tell many things about the operation of the vehicle. Here are some tips on looking at spark plugs to “read” what is happening with your engine:

- **Correct timing, mixture and spark plug heat range**
Ground strap retains “like new” appearance. Edges are crisp, with no signs of discoloration.
Porcelain retains clear white appearance with no “peppering” or spotting.
- **Excessively rich mixture**
Porcelain may be fuel-stained, appearing brown or black. In extreme cases, ground strap, electrode and porcelain may be damp with gasoline, or smell of fuel.
- **Detonation**
Edges of ground strap may become rounded. Porcelain has the appearance of being sprinkled with pepper, or may have aluminum speckles. During heavy detonation, the ground strap tip may burn off. This phenomena can result from excessive ignition timing, too high a heat range spark plug or inadequate fuel octane.
- **Excessively lean mixture**
Edges of ground strap may become rounded. Under moderate overheating, the tip of the ground strap can discolor, usually turning purple, or the entire ground strap can become discolored.

5.0 Ignition Timing and Nitrous

Because we are oxidizing the air/fuel mix going into the engine when nitrous oxide is used, we must pay close attention to the ignition timing profile. Remember, “nitrous” oxygen is more dense than “atmospheric” oxygen and results in an accelerated burn rate of your fuel.

In anticipation of the quicker burn time, you must retard the timing of the ignition system when using nitrous oxide. The more power we try to make, the more timing in degrees we must remove from the timing profile. This is not only in total advance but the time in which we bring timing in (the advance curve).

This is why all nitrous users are so concerned with evidence of detonation. The accelerated burn rate of the air/fuel charge can cause severe detonation without a “nitrous” ignition strategy. A timing profile that is accelerated and a total timing number retarded will keep you from experiencing catastrophic engine damage.

The general rule of nitrous use ignition timing should be to retard the “Total” advance number approximately 2 degrees for every 50 HP increase when using nitrous oxide. It is always best to start with your engines best total timing (without nitrous) and reduce total timing from there. Use an initial timing retard setting that is at least 2-4 degrees more retarded than you expect to be the best setting for your application. All stated timing adjustments listed in jet maps is where the motor being tested worked best.

When using aftermarket ignition components and/or systems, it would be advisable to contact the manufacturer for information on using their components with a nitrous system. It is always better to be very conservative in your timing approach and tune towards an optimum timing setting.

Example:

| | |
|---|--------------------|
| Ignition timing without Nitrous Oxide | 38 degrees “total” |
| 100 HP increase from Nitrous Oxide | 4 degrees “retard” |
| Initial safety margin | 2 degrees “retard” |
| Initial timing with Nitrous Oxide | 32 degrees “total” |

The following test plan, for determining ignition timing, will give you a guide to determine the best timing profile for your vehicle, hopefully avoiding engine damage during the tuning phase:

1. Install the nitrous jetting for a selected horsepower increase. Use the 100 horsepower setting to learn the finer points of working with nitrous oxide. This will keep your margin for error as large as possible.
2. Estimate the reduced ignition timing that you think will produce best power, based upon the 2-degree retard per 50 horsepower increase rule. Here is the Performer RPM jet map for the 70050 system and timing retard recommendations. The timing numbers listed below are **without** a tuning cushion.

Example: Square-Bore Carburetor Jet Map

| Nitrous/Fuel Jetting | Approx. HP Gains | Final Air/Fuel Ratio | Timing Adj. | Footnotes |
|----------------------|------------------|----------------------|----------------|-----------|
| 55/61 | 100hp | 11.0:1 | 32 Deg. Total. | ①③ |
| 71/75 | 150hp | 11.0:1 | 30 Deg. Total. | ①③ |
| 78/82 | 175hp | 11.0:1 | 30 Deg. Total. | ①③ |
| 85/89 | 200hp | 11.0:1 | 28 Deg. Total. | ②④⑤ |
| 99/102 | 250hp | 11.0:1 | 26 Deg. Total. | ②④⑤ |

See page 5 for spread-bore jet map information.

- ① Spark Plugs use Champion RC-12-YC or equivalent.
- ② Spark Plugs use Champion C-614-C or equivalent.
- ③ Fuel use 92 octane pump gasoline or better.
- ④ Fuel use 110 octane race gasoline or better.
- ⑤ Single Plane manifold only. **DO NOT** use a dual-plane manifold at this horsepower level.

5.0 Ignition Timing and Nitrous (cont.)

1. Set ignition timing 2-3 degrees retarded from your best power estimate setting. This is your cushion for error.
2. Stabilize nitrous bottle pressure at 900 to 950 psi. It is best to select a pressure and keep the pressure to +/- 25 psi.
3. Run your vehicle in a controlled manner (like a ¼ mile drag strip) without the use of nitrous. This is called “on motor”. Note vehicle mph as a baseline to measure nitrous assisted increases.
4. Adjust your ignition timing to a nitrous timing setting.
5. Run your vehicle in the same controlled manner (like a ¼ mile drag strip) with the use of nitrous. Note vehicle mph increase and compare it to your baseline.

Note: Listen for any knocking sounds when running the vehicle. Watch your temperature gauges. Continued nitrous use will elevate coolant temperatures. See Testing Checklist for more testing methodology helpful hints.

6. What Happened? Did your vehicle go faster? Slower? What did the engine sound like? Did the nitrous system work? Refer to the timing charts, and examine spark plugs for signs of detonation.
 - a. If power increased or vehicle mph increased and your spark plugs show no signs of overheating or detonation, you could try to increase ignition timing 1 to 2 degrees.
 - b. If power increased or vehicle mph increased and spark plugs begin to show slight signs of detonation - **STOP! Do not** advance timing further. You may choose to reduce timing 2 degrees at this point for an extra margin of safety. At this point, you need to look at the troubleshooting chart on pages 25-28 for assistance. Pay close attention to the fuel supply with your nitrous system.
 - c. If power decreases or vehicle mph decreases, check for a burned spark plug or engine damage, and reduce ignition timing 2 degrees.

Please refer to the Troubleshooting section of this manual for help in determining any system trouble you may feel that you are having.

7. Repeat step 6 until optimum ignition timing is obtained.

| | |
|---|--|
|  | When working with your ignition system, it is a good idea to have a service manual that features your vehicle's ignition system. It is also good practice to have a book that specializes on the specialized techniques required when working with vehicular ignition systems. |
|---|--|

| | |
|---|--|
|  | Anytime you have questions or concerns with your Edelbrock Nitrous System, please call our technical support hotline at 1-800-416-8628 before you start your engine. |
|---|--|

Testing Checklist

Suggestions on how to perform accurate and repeatable tests with a nitrous vehicle.

1. Always use the same test route. A 1/4 or 1/8-mile timed drag strip is a good way to ensure test durations never vary.
2. Always test with your vehicle when up to normal operating temperatures and operating conditions.
3. Ensure all vehicle systems and components are adjusted to proper settings (tire pressures, oil levels, coolant levels, etc.).
4. Always verify fuel pressures and nitrous pressures are the same, every time you test the vehicle. Different pressures will always yield different results.
5. Use all of your senses to determine how your vehicle is operating. Listen for detonation, watch your gauges, smell for strange odors, etc.

6.0 Troubleshooting Your Edelbrock Nitrous System

How to use our Troubleshooting Flowchart:

The troubleshooting of a nitrous system is basic and straightforward. The symptom chart is divided by symptom, cause and action required. Determine your problem (symptom), identify the potential problem (cause) and correct the problem (action required).

Symptom #1... *There is No change in engine speed when fuel solenoid is activated.*

1. System wired incorrectly.
 - a. Compare wiring to schematic.
 - i. Wire per instructions. See page 17 for wiring schematic.
2. Restricted fuel line.
 - a. Inspect fuel line for restrictions.
 - i. Remove restrictions (kinks in rubber line, pieces of rubber hanging in flow path, etc.).
 - ii. Change fuel line routing.
 - b. Check Fuel Pressure.
 - i. Increase fuel delivery as needed.
 - c. Service the nitrous system fuel filter?
 - i. Replace/clean fuel filter.
3. Malfunctioning fuel solenoid.
 - a. Turn arming switch on, engine off. Activate microswitch, listen for the solenoid to "click". If no click is heard...
 - i. Repair/Replace solenoid.
 - ii. Check wire connections.
 - iii. Verify the power is on.
 - iv. Perform the wire "wiggle" test.

Symptom #2... *Change in engine speed when nitrous bottle valve is opened.*

1. Malfunctioning nitrous solenoid.
 - a. Repair/replace solenoid. See solenoid inspection instructions on page 14
2. Contamination in nitrous solenoid.
 - a. Remove and inspect solenoid for dirt around seat area of plunger in solenoid.

Symptom #3... *Engine runs excessively rich when system is activated.*

1. Nitrous bottle valve not fully opened.
 - a. Check bottle valve.
 - i. Open valve fully.
2. Nitrous bottle mounted improperly.
 - a. Mount bottle properly. See manual pages 9-10 for more information.
3. Plugged nitrous filter.
 - a. Clean and/or replace nitrous filter.
 - b. See nitrous solenoid symptom #2.
4. Low bottle pressure.
 - a. Weigh bottle.
 - i. Bottle should be 10 lbs. above empty bottle weight listed on bottle label when full.
 - b. Check bottle temperature.
 - i. Maintain 80 to 85 degrees of bottle surface temperature.

Symptom #4... No change in performance when system is activated.

1. System wired incorrectly.
 - a. Compare wiring to schematic.
 - i. Wire per instructions.
2. Loose ground wires.
 - a. Connect test light to battery "+" (positive) terminal. Check for continuity at grounds.
 - i. Tighten/repair loose grounds.
3. No power to arming switch.
 - a. With ignition on, connect test light to battery "-" (negative) terminal. Check for power at pole #1 on arming switch.
 - i. Repair wiring.
4. Malfunctioning arming switch.
 - a. With ignition on, turn arming switch on. Connect test light to battery "-" (negative) terminal. Check for power at red wire on arming switch.
 - i. Replace arming switch.
5. Malfunctioning microswitch.
 - a. Turn arming toggle off. Close throttle microswitch, check for continuity between microswitch wiring terminals.
 - i. Replace microswitch.
 - b. Check bottle valve.
 - i. Open valve fully.
 - c. Check bottle orientation.
 - i. Mount bottle properly.
6. Inadequate nitrous supply.
 - a. Weigh bottle.
 - i. Bottle should be 10 lbs. above empty bottle weight listed on bottle label when full.
 - b. Check bottle temperature.
 - i. Maintain 80 to 85 degrees of bottle surface temperature.
 - c. Check bottle valve.
 - i. Open valve fully.
 - d. Check bottle orientation.
 - i. Mount bottle properly.
7. Mismatched nitrous/fuel jetting
 - a. Compare jetting to recommended values.
 - i. Install correct jets
 - b. Verify the number stamped in the jet match the desired power level.
 - i. Acquire the right size jets and install correct jets.
8. Excessive fuel pressure.
 - a. Perform Fuel Pressure Test Procedure.
 - b. Install fuel pressure gauge.
 - i. Regulate pressure to proper settings.
9. Loose nitrous solenoid wiring.
 - a. Inspect solenoid wiring. See manual pages 17 for wiring information.
 - b. Consult a book concerning proper wiring methods.
10. Malfunctioning nitrous solenoid.
 - a. Inspect solenoid wiring. See manual pages 17 for wiring information.
 - i. Repair wiring.
 - b. Inspect solenoid. See symptom # 2
 - i. Rebuild/replace solenoid.

Symptom #5... Engine detonates mildly when system is activated.

1. Excessive ignition timing.
 - a. Check Timing.
 - i. Reduce timing in 2-degree increments for every 50 hp.
2. Inadequate octane fuel.
 - a. Verify what gasoline you use.
 - i. Use higher-octane fuel.
3. Spark plug heat range too high.
 4. Verify what heat range the spark plug is, and how it functions in a high load, high performance application.
 - i. Install a performance spark plug.
 - ii. Reduce spark plug heat range.
4. Too little fuel flow.
 - a. Check pressure and flow.
 - i. Correct fuel flow to proper specification.
5. Too much nitrous flow.
 - a. Verify the size of the nitrous jet.
 - i. Install the proper nitrous jet.
 - b. Check bottle temperature and pressure.
 - c. Ensure before every nitrous usage that you only use nitrous when the temperature and pressure of your bottle are correct.

Symptom #6... Engine detonates heavily when system is activated.

Inadequate fuel delivery due to:

1. Plugged fuel filter.
 - a. Inspect fuel filter.
 - i. Clean or replace filter.
2. Crimped fuel line.
 - a. Inspect fuel line.
 - i. Replace crimped line.
3. Weak or inadequate fuel pump.
 - a. Install fuel pressure gauge. Run engine under load at wide-open throttle, with system activated.
 - i. Repair or replace fuel pump.
 - ii. Install nitrous dedicated fuel supply.

Symptom #7... High RPM misfire when system is activated.

1. Excessive spark plug gap.
 - a. Inspect spark plugs.
 - i. Set plug gap at 0.030 – 0.035 inch.
 - ii. Contact the manufacturer of your plugs for more information.
2. Weak ignition/ignition component failure.
 - a. Inspect ignition components.
 - i. Replace worn components.
 - ii. Upgrade ignition system to high performance high load capable ignition components.

Symptom #8... *Vehicle surges under acceleration when system is activated.*

1. Inadequate nitrous supply.
 - a. Weigh bottle.
 - i. Bottle should be 10 lbs. above empty bottle weight listed on bottle label when full.
 - b. Check bottle temperature.
 - i. Maintain 80 to 85 degrees of bottle surface temperature.
 - b. Check bottle valve.
 - i. Open valve fully
 - c. Check bottle orientation.
 - i. Mount bottle properly



Edelbrock Nitrous Systems

This page is left for notes:



Edelbrock Nitrous Systems
2700 California Street
Torrance, California 90503
Phone (800) 416-8628