

# INSTALLATION SHEET

## TUFF TONNO III™

## & Saber TONNO

## extang



**NEW Improved**  
"DOUBLE HOOK"  
Side Rail Clamps

Spring Bows  
(x3-Short Bed)  
(x4-Long Bed)

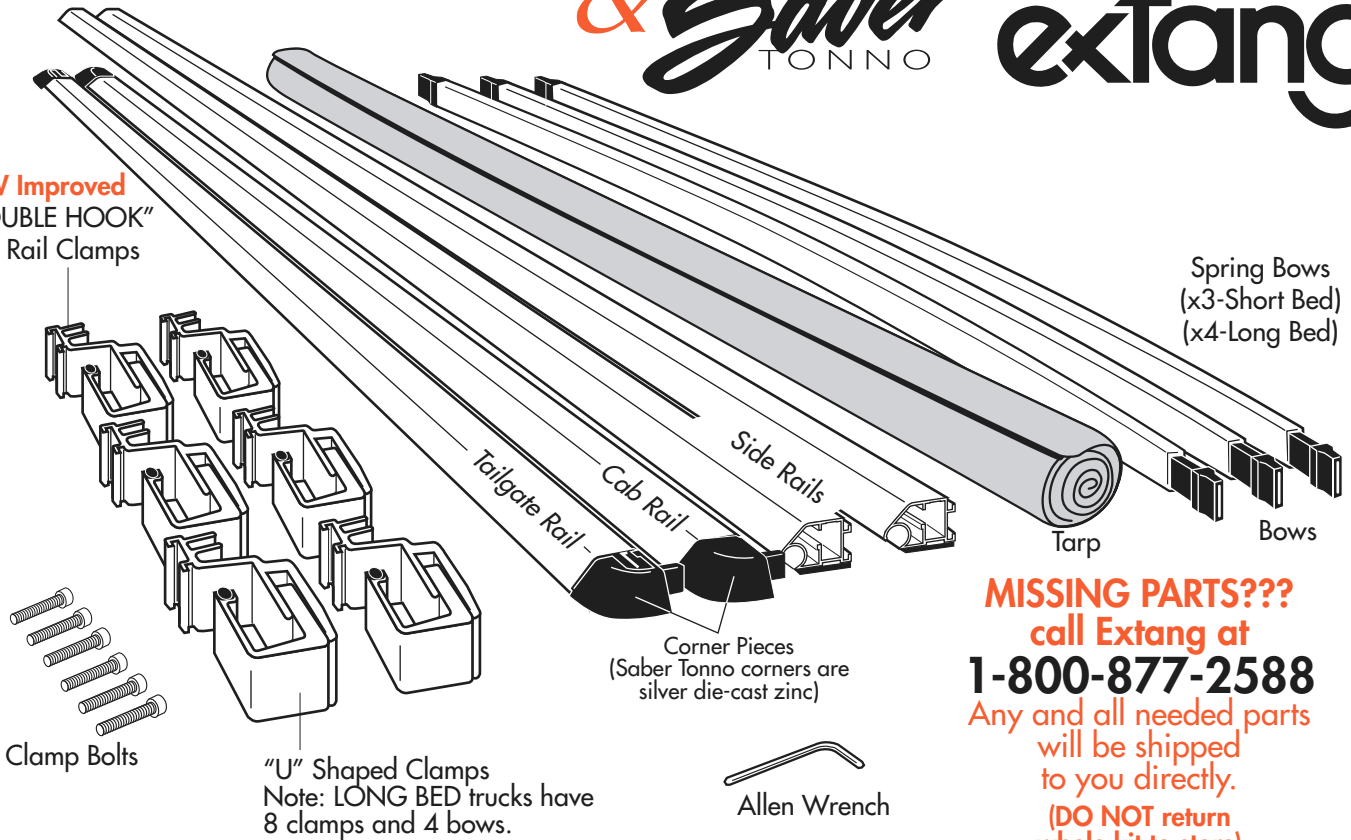

**MISSING PARTS???**  
call Extang at  
**1-800-877-2588**  
Any and all needed parts  
will be shipped  
to you directly.  
**(DO NOT return  
whole kit to store)**

**PARTS INCLUDED IN YOUR KIT.** You may want to lay them out in this manner for accessibility.

**1**

Wash truck bed.

**2**

Foam has **NO adhesive**  
to touch truck finish.

Remove paper tape from all rails.  
Discard properly.

**3**

Depress the mechanism,  
release, and remove one  
corner from cab rail.

LeverLock™  
(Tuff Tonno III)

ClickLock™  
(Saber Tonno)

**4**

Off the truck bed, connect  
the end rails to the two  
side rails.

Feed tarp dowel into  
cab rail. **NOTE:** For  
easiest feeding action,  
place tarp on a flat  
smooth surface, and keep  
dowel straight while  
feeding into cab rail.

**Caution,  
pavement may  
scuff tarp.**

Reinsert corner piece into  
cab rail until it "clicks" and  
locks into place.

**extang**  
Stands for Quality

Extang Corporation  
1901 E. Ellsworth Rd.  
Ann Arbor, MI 48108  
734 677-0444, Fax: 734 677-8409

Visit us at:  
**www.extang.com**

Item No. 0018-1202 RH Printed in U.S.A.

## For an OVER-THE-RAIL Bedliner

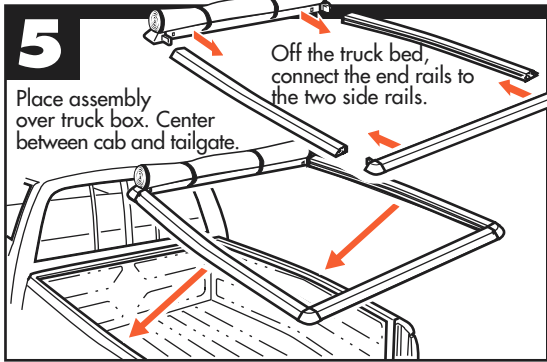

DIAGRAM  
**A**

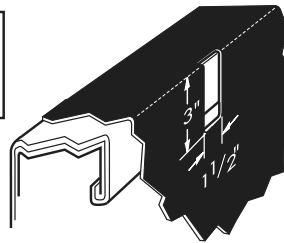
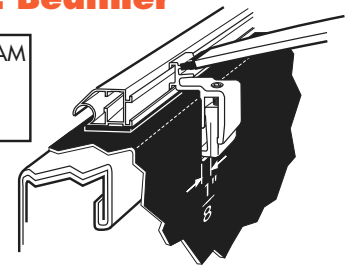
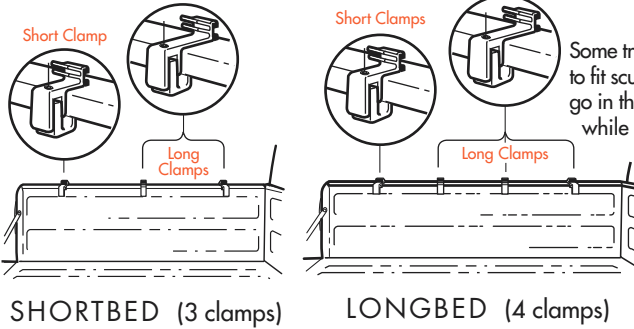
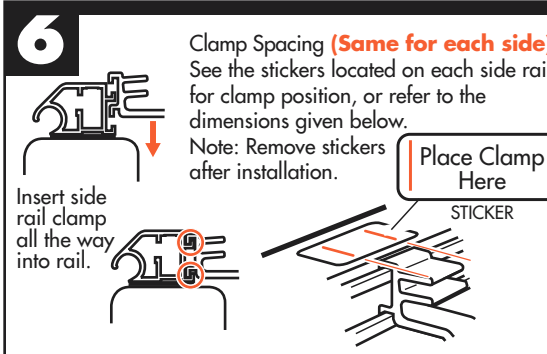

DIAGRAM  
**B**



For each clamp mark on your bedliner a 1-1/2" x 3" hole as shown above. Remove clamp. Cut holes in bedliner. Reinsert side rail clamp. Return to step 5.

Side rail clamped to bed with bow attached.



### Longer Clamps

Some trucks use two lengths of bracket to fit sculpted sidewalls. Longer clamps go in the forwardmost (Cab) positions while the shorter pair hold the rails at the rear (tailgate) end.

### FOR INSTALLATION IN THE FOLLOWING TRUCK MODELS:

Ford HD Long-Bed  
Ford HD Short-Bed

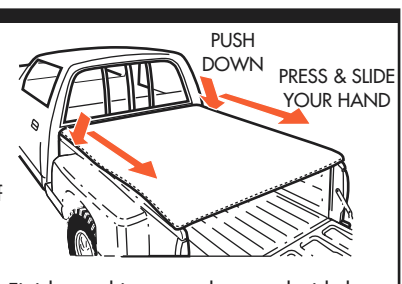
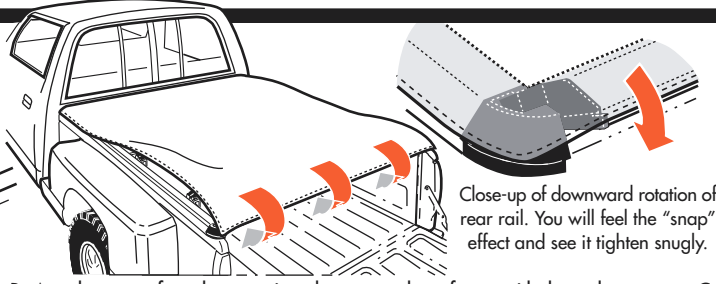
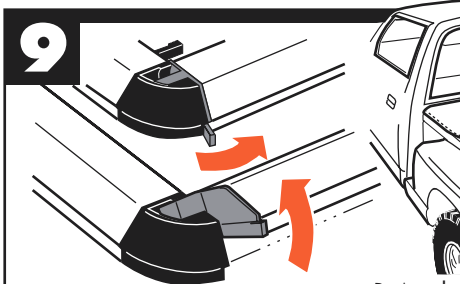
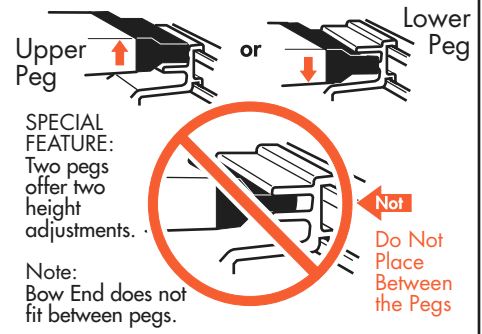
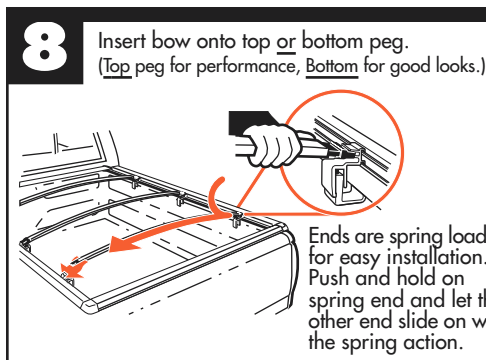
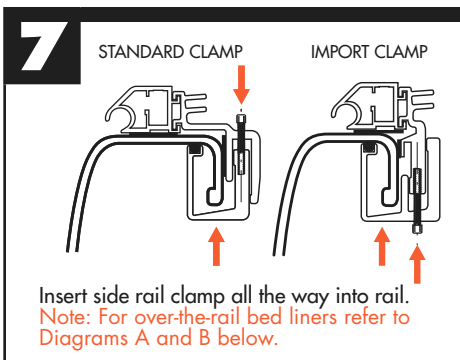

### For Tuff Tonno III:

### For Saber Tonno:

