

# INSTALLATION SHEET

# FULLTILT™

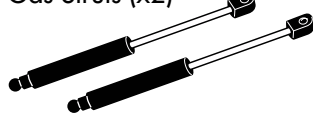

Gas Struts (x2)



Spring Bows  
(x3-Short Bed)  
(x4-Long Bed)

Lower Hinge Rail

"L" Bars  
(L and R)  
with clamps  
included

Side Rails  
(L and R)

Tailgate  
Rail

Upper Hinge Rail Assembly  
w/Tarp attached

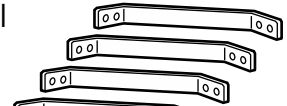

Corner  
Braces (x4)



Allen Wrenches  
(3 sizes)

**MISSING PARTS???**

**Call Extang at 1-800-877-2588**

Any and all needed parts will be shipped to you directly.  
(DO NOT return whole kit to store)

PARTS INCLUDED IN YOUR KIT. You may want to lay them out in this manner for accessibility.

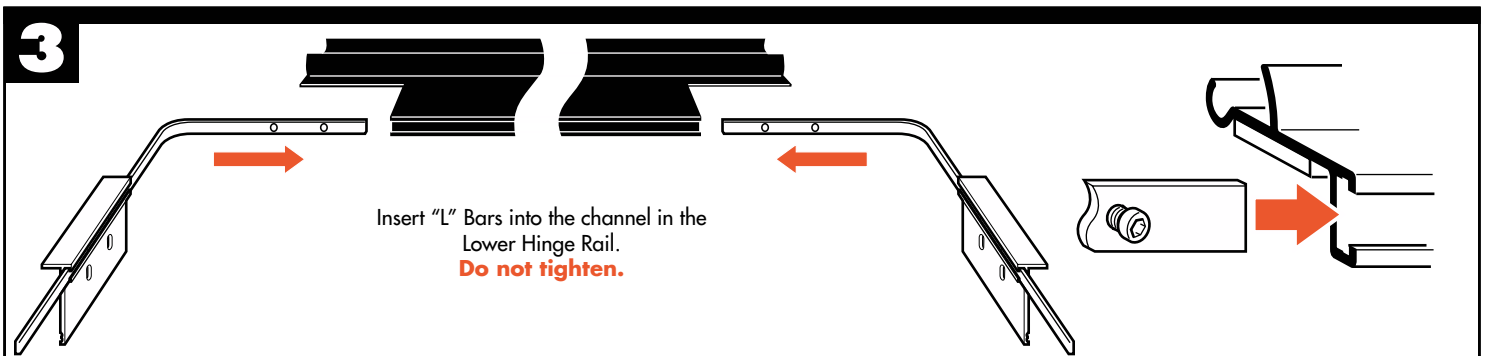
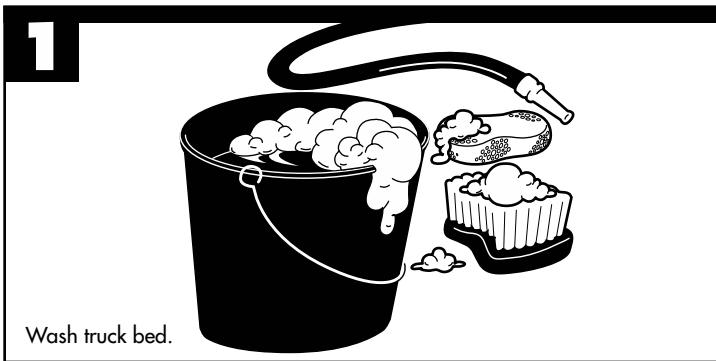

**extang**  
Stands for Quality

Extang Corporation  
1901 E. Ellsworth Rd.  
Ann Arbor, MI 48108  
734 677-0444, Fax: 734 677-8409

Visit us at:  
**www.extang.com**

Item No. 0035-0502RH Printed in U.S.A.

**4** Set assembly into the forward end of payload bed. The forward channel of the Lower Hinge Rail centers over front wall edge.

Adjust front clamps as far forward as possible.  
**Tighten both Allen bolts.**

**5**

Adjust "L" bars out so that neoprene pads rest on side walls of payload bed.

**6**

Adjust clamp for each side bracket with two clamp bolts. Set clamp in highest possible groove. (Small bead of clamp fits groove in plate.)  
**Do not tighten.**

**7**

Rotate Upper Hinge Rail Assembly (at least 45°) and fit into curved channel of Lower Hinge Rail.

Rotate Upper Hinge Rail Assembly down so that deep channel engages the ridge on the Lower Hinge Rail. Unroll tarp over truck cab.

**8**

Attach Side Rails to Upper Hinge Rail Assembly with brackets inside payload bed, and locking levers to rear. Be sure that ClickLock™ closures are fully secure.

**9**

Attach Tailgate Rail to Side Rails and center entire assembly side-to-side, leaving adequate clearance at front with the truck cab.

**10**

The forward channel of the Lower Hinge Rail should center over front wall edge of the payload bed.

Tighten front Allen bolts (x4) and side clamp bolts (x8) with large and medium wrenches provided. Connecting "L" bars firmly to the Lower Hinge Rail and the walls of the payload bed.

**11**

Remove each pair of corner small Allen bolts on ends of rails and insert diagonal bracket between them.  
**Do Not Tighten at this time.**

Square the tonno frame by aligning to side rails of truck, or measuring diagonally, corner-to-corner, and make sure that dimensions are equal. (This can be done with frame detached from truck.)

With tonno frame squared, retighten the corner Allen bolts.  
Note: Be sure that all corner members are seated inside of rails

# 12

Frame Locking Lever must be parallel to side rail when opening and closing tonno.

Locking Lever is secure when positioned at right angle to, and engaged with side wall.

Locking Levers come from the factory ready to fit your truck.

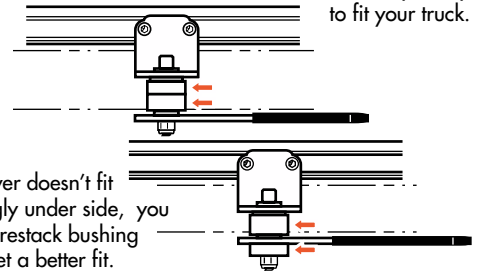
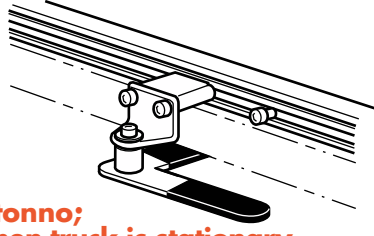
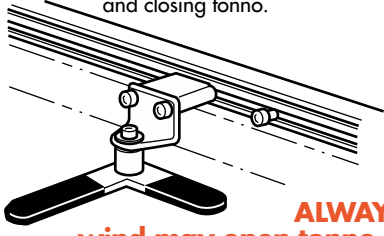

**ALWAYS latch tonno; wind may open tonno, even when truck is stationary.**

If lever doesn't fit snugly under side, you can restack bushing to get a better fit.

# 13

Insert bow onto top or bottom peg, (Top peg for performance, Bottom for good looks.)

Ends are spring loaded for easy installation. Push and hold on spring end and let the other end slide on with the spring action. **NOTE: Center bow provides support to side rails and may seem tight when inserting between side rails. It may be necessary to pull out on side rails to install the center bow.**

Upper Peg

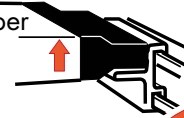

or

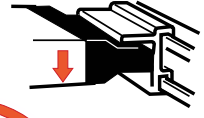

Lower Peg

**SPECIAL FEATURE:** Two pegs offer two height adjustments. Note: Bow End does not fit between pegs.



Not

Do Not Place Between the Pegs

# 14

**Start at Corners**

Attach tarp by starting at the corners, and snap in place.

**SPECIAL FEATURE**

**Weather-adjustable Snaps**

**If it gets too cold, just bring the tonno inside!**

Studs Down

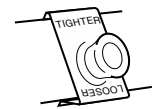

Slides Off

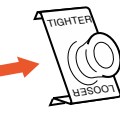

Rotate 180°

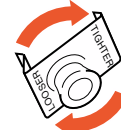

Studs Up



**SUMMER SETTING**

Takes up slack in tarp caused by warm weather.

**WINTER SETTING**

Allows more slack in tarp for cold temperatures.

# 15

Place sockets of Gas Strut over ball joints on each bracket (cylinder-end attaches to truck). Cylinder (round) socket should press easily over the lower ball. Press retainer of upper socket into the ball to lock securely in place. To remove cover from truck, disengage Gas Strut at lower joint only.

**NOTE: Round socket will release with hand pressure. Do not remove strut from tonno frame.**

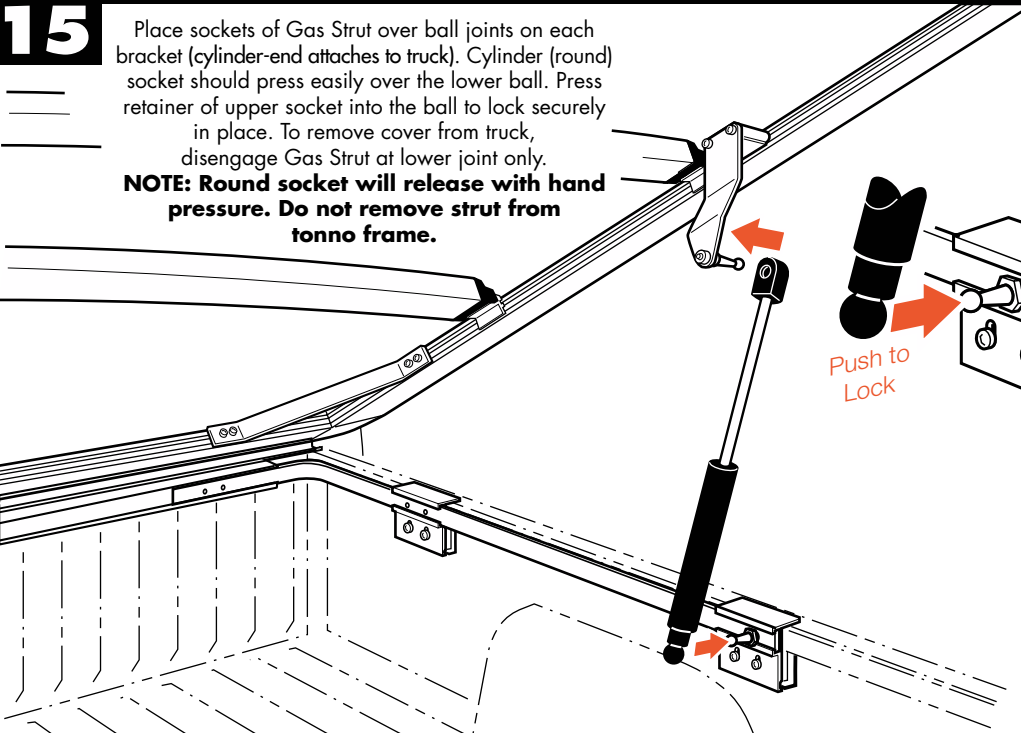

Push to Lock

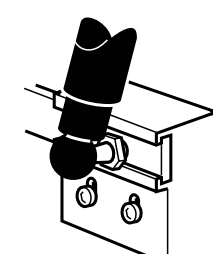
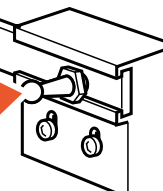

Pull to Release

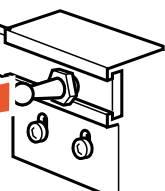

# Operating Your FullTilt™ Tonno

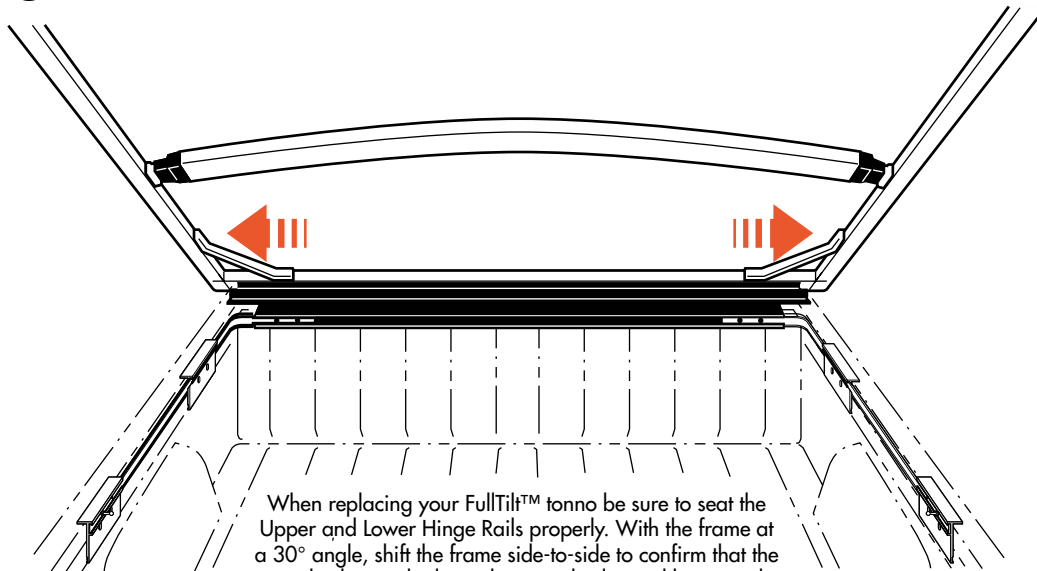

When replacing your FullTilt™ tonno be sure to seat the Upper and Lower Hinge Rails properly. With the frame at a 30° angle, shift the frame side-to-side to confirm that the curved ridge on the lower hinge rail is located between the tonno frame corner caps.

**When in the proper position, the frame should freely translate about 1/8".**  
**If not, raise the frame and seat it again.**

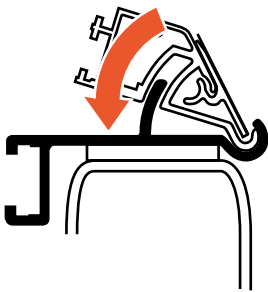

Make sure that Upper Hinge Rail Assembly slides easily over ridge on Lower Hinge Rail.

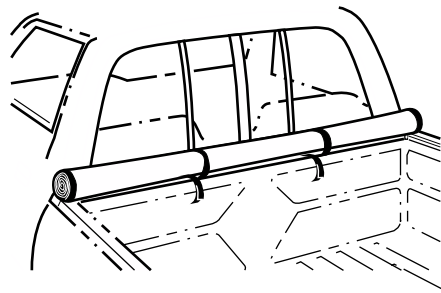

If you need to tow your vehicle backward, be sure to release the cover and stow against the hinge rail using Velcro® straps provided.

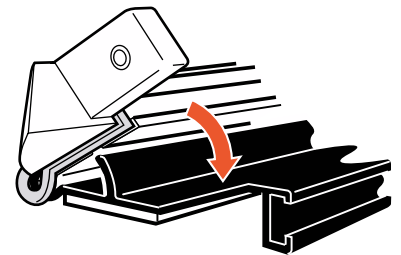

When the Upper Hinge Rail Assembly is properly centered side to side—the rail will rotate easily. Be sure that steel Rail End Plates are in place to keep rails from jamming.

## WARNING!

**High winds may catch the tonno cover and cause it to open if not latched. Be very careful raising tonno in windy conditions.**

**Cover should always be latched when down.**

**Do not drive with cover raised or unlatched, even at slow speeds.**

**When towing vehicle backwards, cover must be removed or tarp fully rolled and secured with Velcro® straps.**

### Quick and Easy Removal

- Step 1- Lift and hold cover while releasing the lower joint of the gas strut.
- Step 2- Rotate the cover upward past 45° and lift out of the quick-hinge front rail system.
- Step 3- Slide off the Lower Hinge Rail.

### Quick and Easy Reattachment

- Step 1- Lift cover as a unit and drop front edge into the quick-hinge front rail system groove. Be careful that locking tongue (vertical web) is between both corner pieces and Rail End Plates. There is about 1/8" total clearance on the ends. Slowly and gently rotate downward. **DO NOT FORCE! IT SHOULD FALL INTO PLACE!!** Note: Frame should slide side-to-side about 1/8" freely, **If hinge is tight, something is wrong, you are most likely not centered.**
- Step 2- Reattach the gas struts with body on bottom in open position. Drop cover and latch both sides securely.