



# DELTA FORCE

COLD AIR INTAKES  
BY FLOWMASTER

## Installation Instructions for: SYSTEM #615104

2011-2015 CAMARO  
3.6L Engine

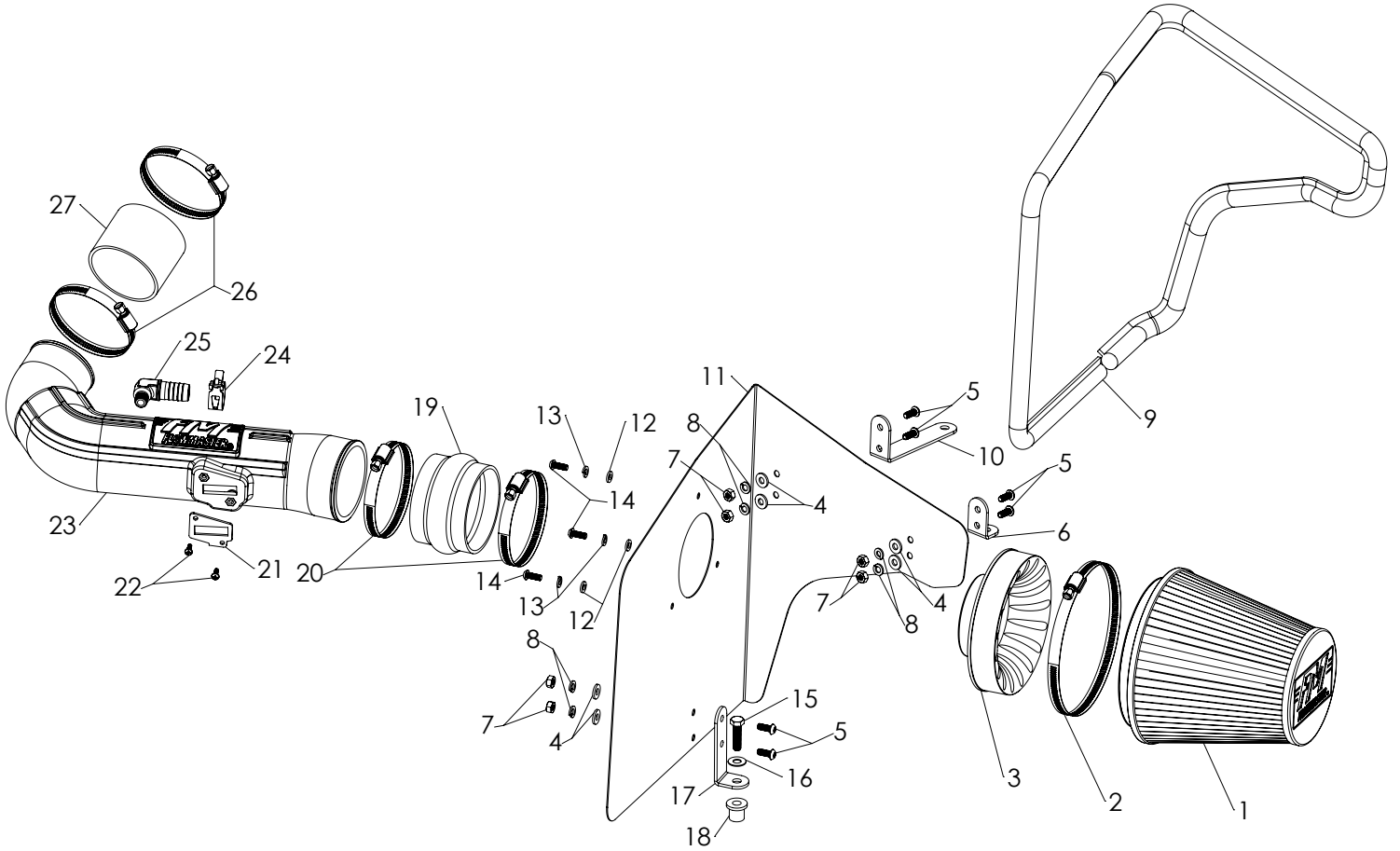

ITEM NO.	PART NUMBER	DESCRIPTION	QTY.
1		FILTER, AIR 7.5" HIGH, 6" DIA FLANGE	1
2	AF1002	#104 HOSE CLAMP 4.125 TO 7" DIA.	1
3	AF6001	3.5" AIR FILTER ADAPTER	1
4	HW320	1/4" FLAT WASHER SAE SS	6
5	HW245	1/4"-20 X 5/8" BTNHD SS	6
6	AF5001	1" BRACKET 1	1
7	HW115	1/4"-20 NUT SS	6
8	HW322	1/4" SPLIT LOCK WASHER SS	6
9	49000061	PUSH IN VINYL AIR BOX TRIM SEAL	1
10	AF5003	1" BRACKET 3	1
11	AF3012	11-15 CAMARO BASE V6 3.6L INTAKE AIRBOX	1
12	HW319	M6 FLAT WASHER SS	3
13	HW318	M6 SPLIT LOCK WASHER SS	3
14	HW244	M6 X 1.0 X 16MM BTNHD SS	3

ITEM NO.	PART NUMBER	DESCRIPTION	QTY.
15	HW246	5/16"-18 X 1.25" HEX HEAD SS	1
16	HW321	5/16" FLAT WASHER SS	1
17	AF5002	1" BRACKET 2	1
18	HW108	5/16"-18 RUBBER WELL NUT	1
19	AF4019	3.5"ID X 2.5"L RUBBER COUPLER, HUMP	1
20	MC350H	#56 HOSE CLAMP 3 1/16 TO 4" DIA.	2
21	GA139	MAF SENSOR GASKET	1
22	HW248	M4 X 0.7 X 12MM RH PHILLIPS SCREW SS	2
23	AF2012	10-15 CAMARO BASE V6 3.6L INTAKE TUBE	1
24	MC005P	3/4" HOSE PINCH CLAMP	1
25	AF4014	3/4" BARB TO 1/4" NPT MALE 90DEG	1
26	MC314H	#52 HOSE CLAMP 2 13/16 TO 3 3/4" DIA.	2
27	AF4030	3.0"ID X 2.5"L RUBBER COUPLER, STRAIGHT	1





7. Disconnect the positive crankcase ventilation (PCV) tube from its fitting on the intake tube.



8. Loosen the hose clamp that secures the intake tube to the throttle body.



9. Remove the 2 airbox nuts. Firmly lift the airbox straight up to release it from its rubber grommet, then carefully remove the airbox and intake tube from the vehicle. **Retain nuts for reinstallation at Step 16.**



10. Remove rubber grommet from vehicle frame.



11. Remove the MAF sensor from the intake tube, then remove the factory gasket from the sensor. **CAUTION: The sensor is delicate!** Handle with care, and store in a safe location until reinstallation.

**ASSEMBLE AND INSTALL YOUR FLOWMASTER COLD AIR INTAKE SYSTEM:**

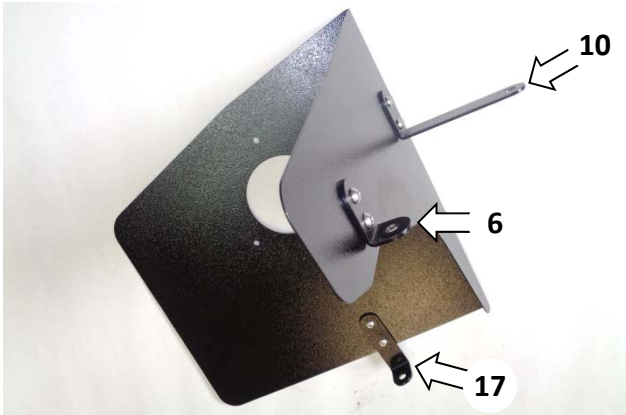

12. Attach brackets (6), (10) and (17) to airbox (11) at the locations shown, using ¼-20 screws (5) (against the brackets), and flat washers (4), lock washers (8) and nuts (7) (against the airbox).

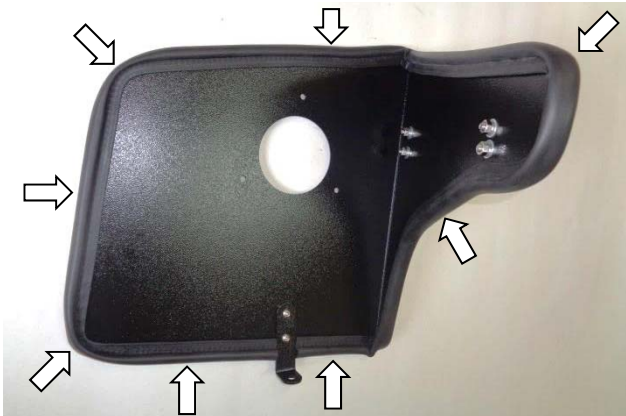

13. Attach rubber trim seal (9) to airbox . Starting next to bracket (17), press trim seal fully onto edge of airbox, slowly working around the airbox. When you return to the other side of bracket (17), trim the seal to fit using metal cutting shears.

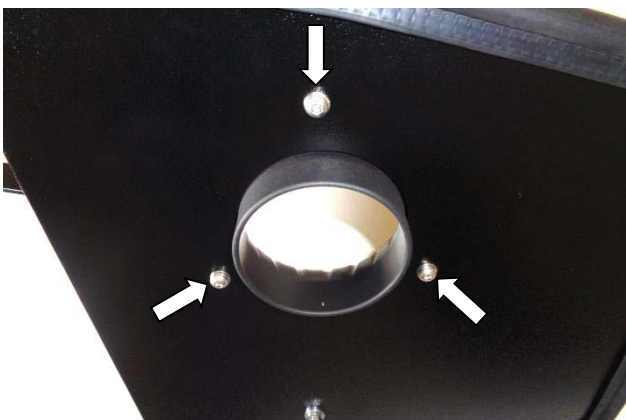

14. Attach air filter adapter (3) to airbox using M6 screws (14), lock washers (13) and flat washers (12).

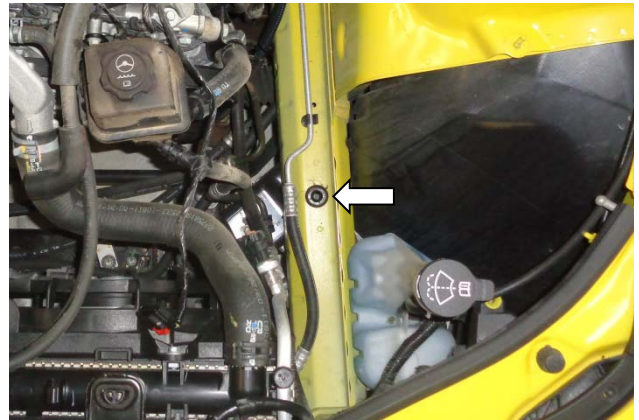

15. Place rubber well nut (18) in the mount hole that the grommet was removed from in Step 10.

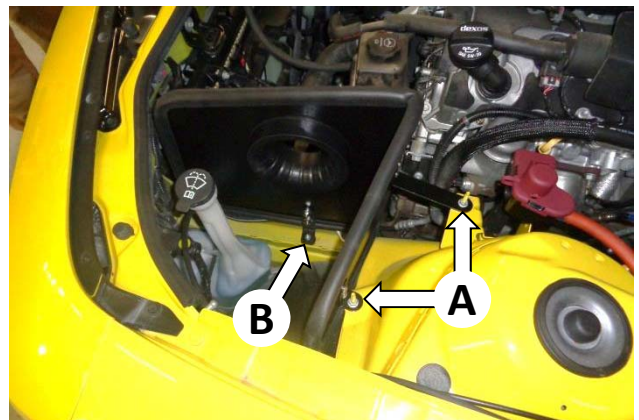

16. Install the assembled airbox:

- A. Slip the 2 upper brackets over the studs, and hand-start the nuts removed at Step 9.
- B. At the lower bracket, install the 5/16-18 bolt (15) and flat washer (16) in the well nut. Tighten all three fasteners.



17. Apply 2 wraps of nylon thread tape to threads of PCV elbow (25), and install elbow into intake tube (23).



18. Install MAF sensor gasket (21) onto the sensor, ensuring correct orientation. Then install sensor in intake tube, using M4 screws (22).



19. Install 2 hose clamps (20) on flex (or humped) coupler (19), then install coupler on intake end of intake tube. Orient clamp screws upward to allow tightening after installation on vehicle.

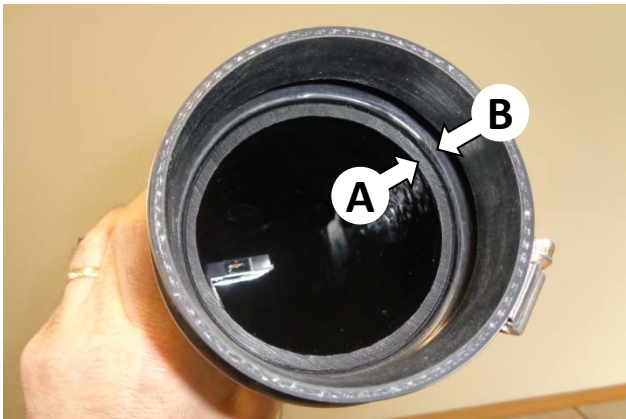

20. To allow proper flexing of the flex coupler during engine torqueing, verify that the end of the intake tube (A) sits behind the coupler's transition lip (B).



21. Install 2 hose clamps (26) on straight coupler (27), then install coupler on discharge end of intake tube. Orient clamp screws upward to allow tightening after installation on vehicle.



22. Install assembled intake tube in vehicle and tighten all hose clamps.



23. Install clamp (2) on air filter (1), install filter on filter adapter and tighten clamp.

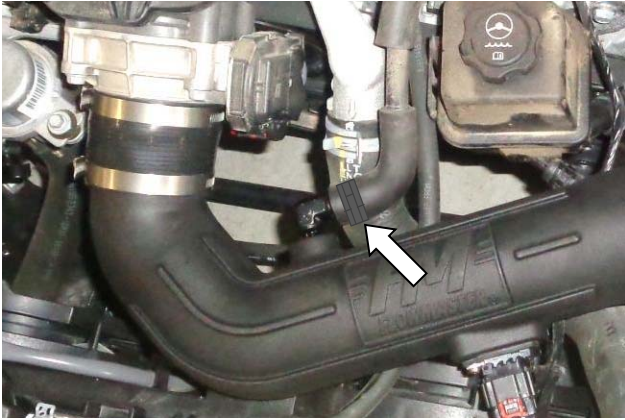

24. Install pinch clamp (24) on PCV hose, then install hose on elbow, checking for secure installation.



25. Reinstall the connector on the MAF sensor and close the locking tab, checking that the connector is secure.



26. Remove the oil fill cap and temporarily protect the open fill neck with a clean paper towel. Reinstall the engine heat shield, remove the paper towel from the fill neck, and reinstall the fill cap.

**Congratulations, the installation of your FLOWMASTER cold air intake kit is now complete!**