

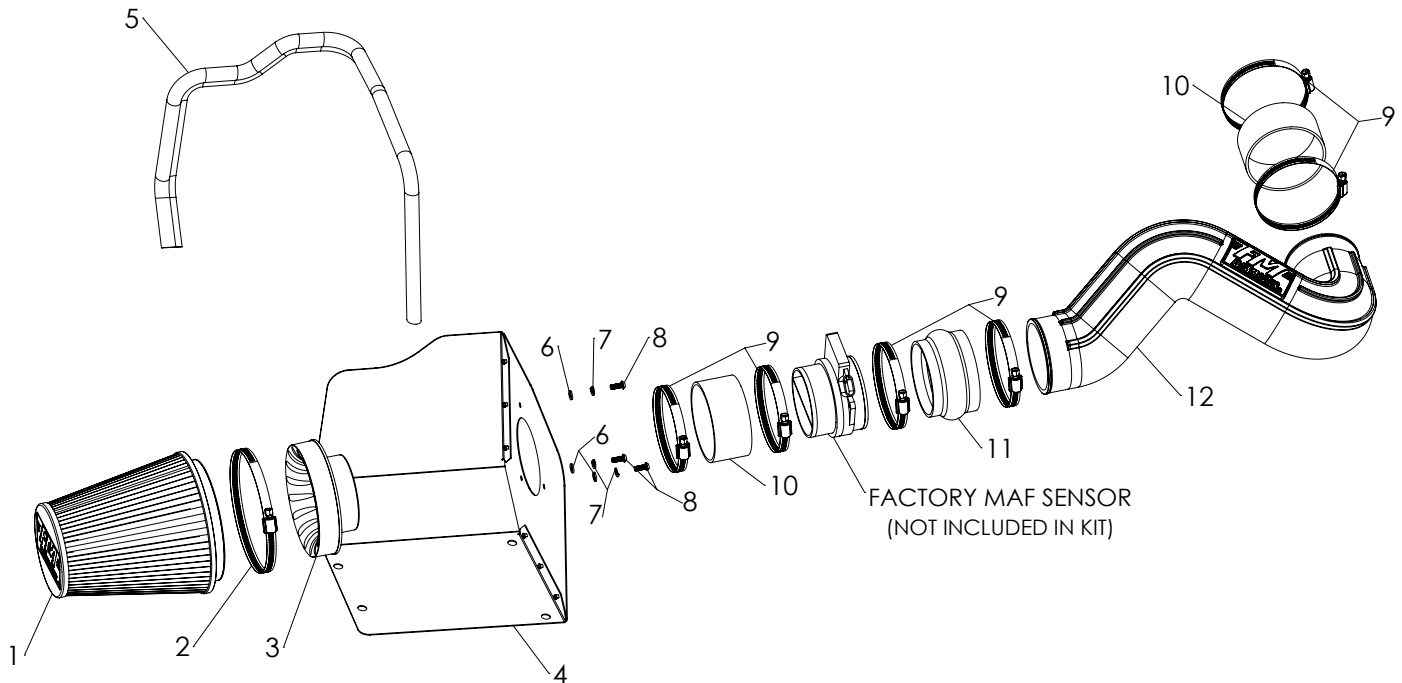

# Installation Instructions for: SYSTEM #615118

2005-2007 GM 1500  
4.8L, 5.3L, 6.0L, & 6.2L Engines



ITEM NO.	PART NUMBER	DESCRIPTION	QTY.
1	AF1001	FILTER, AIR 8.625" HIGH, 6" DIA. FLANGE	1
2		#104 HOSE CLAMP 4.125 TO 7" DIA.	1
3	AF6002	4" AIR FILTER ADAPTER	1
4	AF3002	05-07 GM 1500 INTAKE AIRBOX	1
5	49000061	PUSH ON VINYL AIR BOX TRIM SEAL	1
6	HW319	M6 FLAT WASHER SS	3
7	HW318	M6 SPLIT LOCK WASHER SS	3
8	HW244	M6 X 1.0 X 16MM BTNHD SS	3
9	MC400H	#64 HOSE CLAMP 3 9/16 TO 4.5" DIA.	6
10	AF4004	4.0" X 2" L RUBBER COUPLER, STRAIGHT	2
11	AF4009	3.75-4.0" ID X 2.5" L RUBBER COUPLER, HUMP	1
12	AF2002	05-07 GM TRUCKS, 4.8L, 5.3L, 6.0L & 6.2L INTAKE TUBE	1

## VERIFY KIT CONTENTS:



1. Before starting, use the exploded drawing and parts list (front page) to verify the contents and condition of your kit. In the unlikely event that any parts are missing or damaged, please contact FLOWMASTER Technical Support (see number below) to receive replacements.

## REMOVE FACTORY AIR INTAKE SYSTEM:

NOTE: Please refer to vehicle manufacturer's recommendations regarding removal of factory components.

2. **Turn off the vehicle's ignition and disconnect the negative battery cable.**

NOTE: Disconnecting the negative battery cable erases pre-programmed electronic memories. Write down all memory settings before disconnecting the negative battery cable. Some radios will require an anti-theft code to be entered after the battery is reconnected. The anti-theft code is typically supplied with your owner's manual. In the event that your vehicle's anti-theft code cannot be recovered, contact an authorized dealership to obtain your vehicle's anti-theft code.



3. Remove the engine heat shield.



4. Loosen the hose clamp that secures the intake tube to the throttle body.

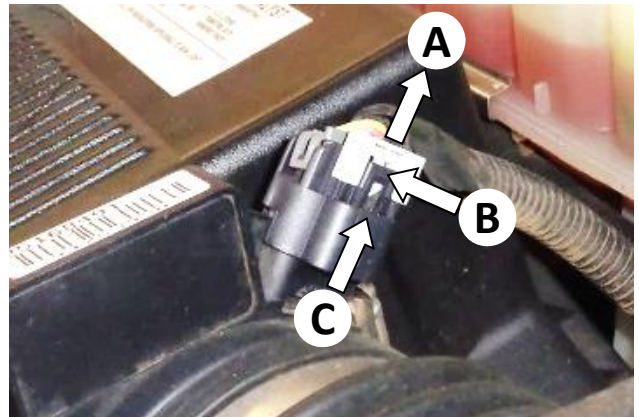

5. Carefully remove the mass airflow (MAF) sensor plug as follows:
  - A. Pull the locking tab out until it stops; then
  - B. depress the latch, while
  - C. pulling the plug straight off the sensor.



6. Loosen the hose clamp that secures the intake tube to the MAF sensor.



9. Loosen the hose clamp that secures the MAF sensor to the airbox, and remove the sensor.  
**CAUTION: The MAF sensor is delicate – handle with care!**



7. Disconnect the coolant hose clamps from the intake tube.



10. Remove the clamp and rubber seal from the MAF sensor. **Store the sensor in a safe location until reinstallation.**



8. Remove the intake tube from the vehicle.

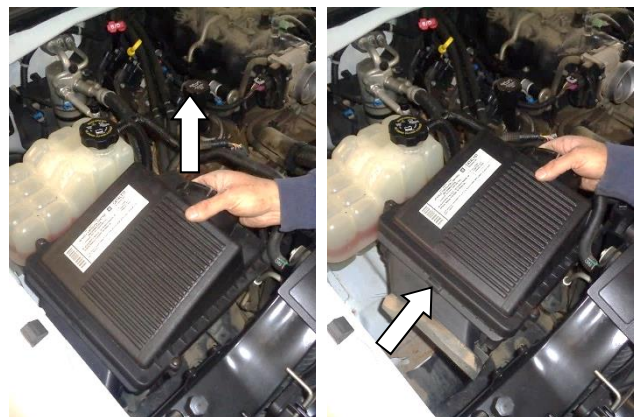

11. Remove the stock airbox. First, grasp its inlet side and lift straight up to release its 2 mount pins from their rubber grommets. Then slide the airbox inboard to release it from the airbox shelf.

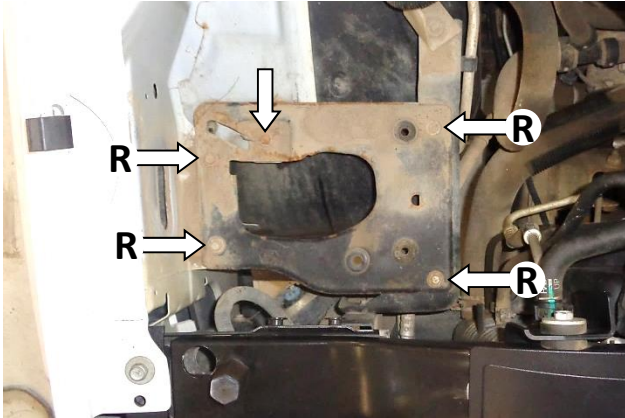

12. Finally, remove the airbox shelf by removing its 5 mount bolts. Retain the 4 bolts marked "R" above. **NOTE: To maintain proper hardware clearances at installation (see Step 18), make note of the length of the bolts removed from locations "R."**

**NOTE: We highly recommend that you retain all factory air intake system components.**

### ASSEMBLE AND INSTALL YOUR FLOWMASTER COLD AIR INTAKE SYSTEM:



13. Attach rubber trim seal (5) to the airbox (4) along the edges shown. Starting at one end, press the seal fully onto edge of airbox, gradually working around the airbox. When you reach the end point, trim the seal to fit using metal-cutting shears.

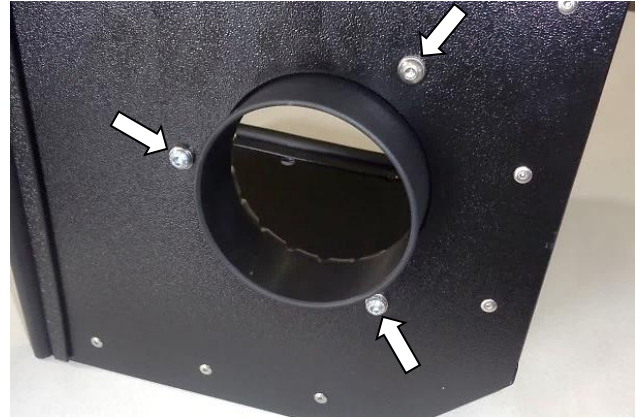

14. Attach air filter adapter (3) to airbox using M6 screws (8), lock washers (7) and flat washers (6).



15. Install 2 hose clamps (9) on flex (or humped) coupler (11), then install coupler on intake end of intake tube (12). Orient clamp screws upward to allow tightening after installation on vehicle.

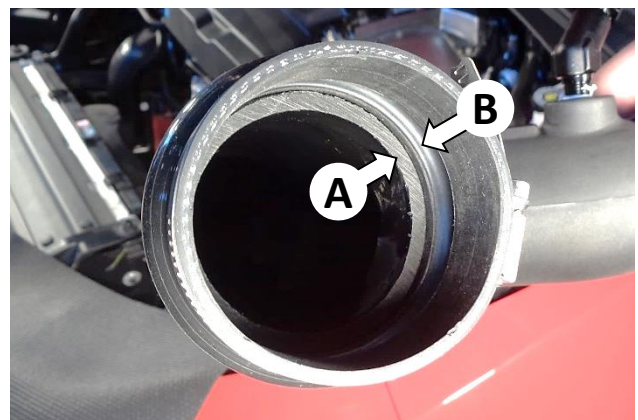

16. To allow proper flexing of the coupler during engine torqueing, verify that the end of the intake tube (A) sits behind the coupler's transition lip (B).



17. Install 2 clamps (9) on straight coupler (10), then install coupler on discharge end of the intake tube. Orient clamp screws upward to allow tightening after installation on vehicle.



18. Install MAF sensor in end of flex coupling. Then install 2 clamps (9) and straight coupler (10) on other end of MAF sensor. Orient clamp screws upward to allow tightening after installation on vehicle.

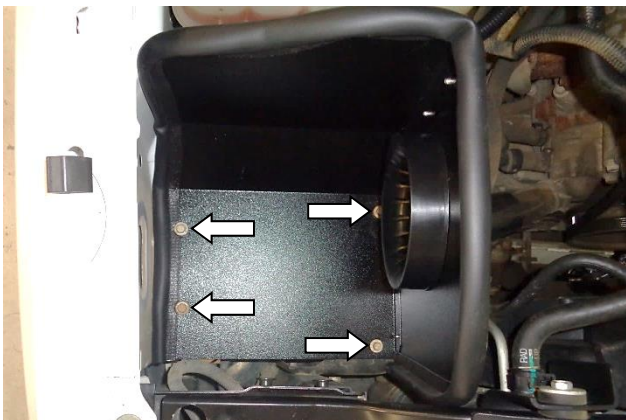

19. Use the 4 bolts retained at Step 12 to install the assembled airbox in the vehicle. **NOTE: Be sure to use the correct length bolt at each location, as determined at Step 12.**



20. Install assembled intake tube in vehicle and tighten all hose clamps.



21. Reinstall the connector on the MAF sensor, close the locking tab, and check that the connector is secure.



22. Install clamp (2) on air filter (1), install filter on filter adapter, and tighten clamp.



22. Reinstall the engine heat shield.



**Congratulations, the installation of your FLOWMASTER cold air intake kit is now complete!**