

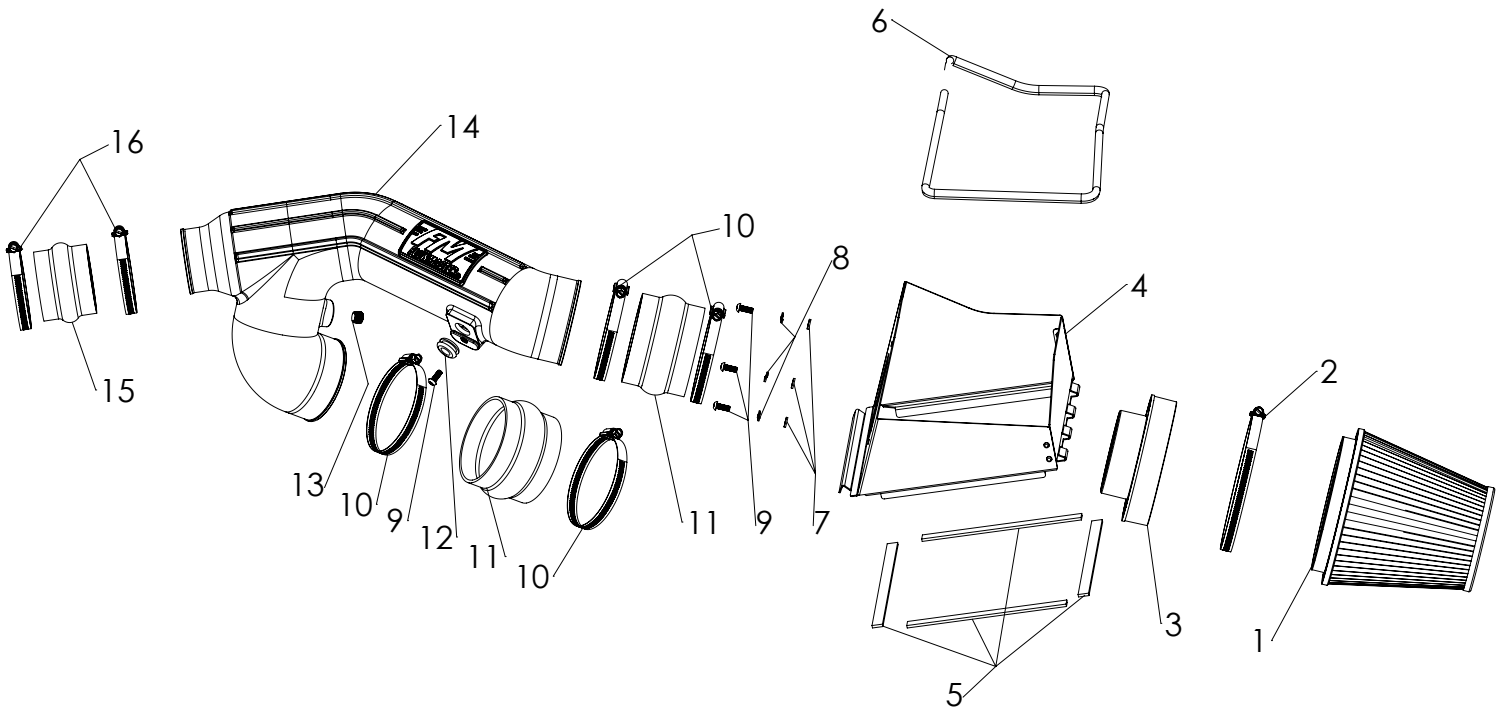

# Installation Instructions for: SYSTEM # 615149 2012-2014 FORD F-150 TRUCKS with 3.5L Engines

NOT LEGAL FOR SALE OR USE ON ANY POLLUTION-CONTROLLED MOTOR VEHICLE IN CALIFORNIA OR IN STATES THAT HAVE ADOPTED CALIFORNIA EMISSION PROCEDURES.



REV. 9/18/17

ITEM NO.	PART NUMBER	DESCRIPTION	QTY.
1	AF1002	AIR FILTER 7-1/2" x 6" DIA	1
2		SCREW CLAMP, #104 (4-1/8" - 7")	1
3	AF6002	ADAPTER, AIR FILTER 4" x 6"	1
4	AF3018	HEAT SHIELD, 11-14 FORD F-150 3.5L	1
5	49000067	SEAL STRIP, ADHESIVE, 1/8" x 1/2"	48"
6	49000061	GASKET, HEAT SHIELD	48"
7	HW319	FLAT WASHER, M6	3
8	HW318	LOCK WASHER, M6	3

ITEM NO.	PART NUMBER	DESCRIPTION	QTY.
9	HW244	SCREW, M6 x 1.0 x 16MM	4
10	MC400H	SCREW CLAMP, #64 (3-9/16" - 4-1/2")	4
11	AF4005	COUPLER, FLEX 4" I.D. x 3" L	2
12	AF4008	GROMMET, 1-1/16" OD x 1/2" ID x 7/16" THK	1
13	AF4033	PLUG, 1/4" NPT	1
14	AF2028	INTAKE TUBE, 11-14 FORD F-150 3.5L	1
15	AF4036	COUPLER, FLEX, 3" I.D. x 2-1/2" L	1
16	MC314H	SCREW CLAMP, #52 (2-13/16" - 3-3/4")	2

**REVIEW THE INSTRUCTIONS AND VERIFY THE KIT CONTENTS:**

1. Please take a moment to read and understand these instructions before installing your Flowmaster cold air intake kit.



2. Use the parts drawing and list (front page) to verify your kit's contents.

In the unlikely event that any parts are missing, please contact FLOWMASTER Technical Support for replacements.

**REMOVE THE FACTORY AIR INTAKE SYSTEM:**

**NOTES**

- We highly recommend that you retain all factory air intake system parts.
  - Please refer to vehicle manufacturer's recommendations regarding removal of factory components.
  - Disconnecting the negative battery cable erases pre-programmed electronic memories. Write down all memory settings before disconnecting the negative battery cable. Some radios will require an anti-theft code to be entered after the battery is reconnected. The anti-theft code is typically supplied with your owner's manual. In the event your vehicle's anti-theft code cannot be recovered, contact an authorized dealership to obtain your vehicle's anti-theft code.
3. Turn off the vehicle's ignition and disconnect the negative battery cable.



4. Loosen the screw clamps on the three ends of the air intake duct.

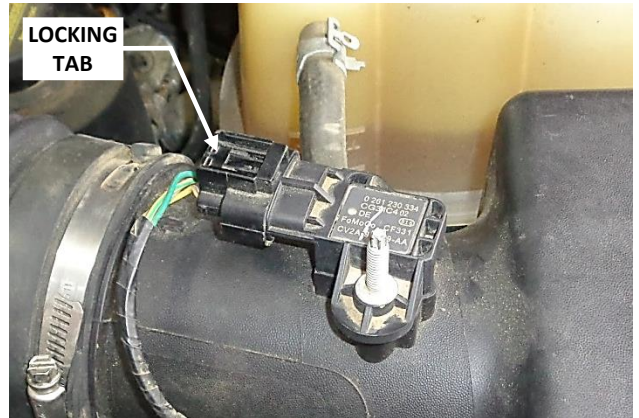

5. Disconnect the electrical plug from the Mass Airflow (MAF) sensor by squeezing the locking tab, then pulling the plug straight off the sensor.



6. Release the three airbox cover latches.



7. Separate the intake duct from the two turbocharger inlets and remove the intake duct and airbox cover as a unit. Then remove the stock air filter.

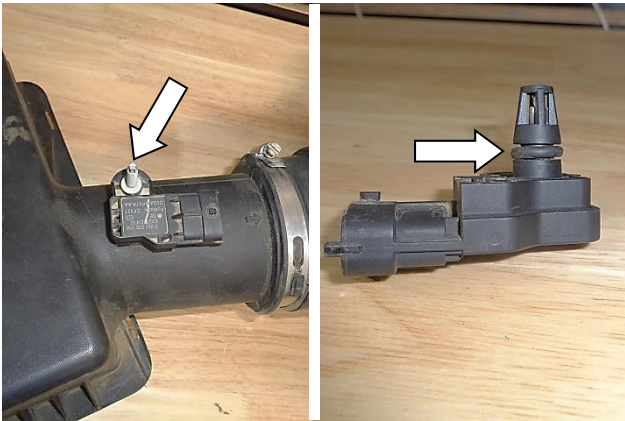

8. Remove the MAF sensor from the intake duct, then remove the o-ring from the sensor. **CAUTION: The sensor is delicate!** Handle it with care, and store it in a safe location until reinstallation.

## ASSEMBLE AND INSTALL YOUR FLOWMASTER COLD AIR INTAKE SYSTEM:

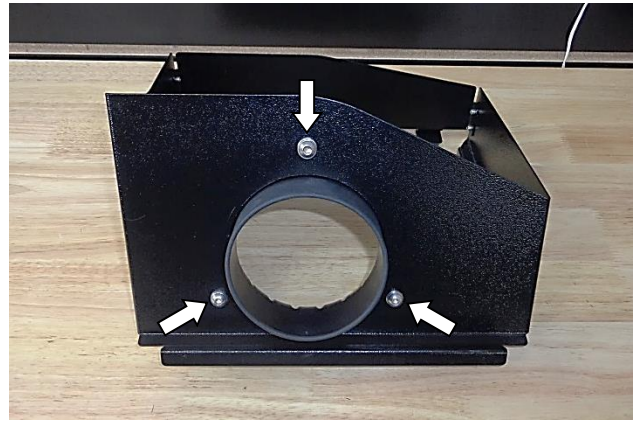

9. Assemble the air filter adapter (3) to the heat shield (4) using the M6 screws (9), lock washers (8) and flat washers (7).



10. Attach the gasket (6) to the heat shield. Firmly press the gasket onto the heat shield, gradually working your way around. When you return to the starting point, use metal-cutting shears to trim the gasket to length.



11. Cut the adhesive seal strip (5) to the lengths required, and apply it to the four flat edges of the heat shield.



12. Slip screw clamp (2) onto air filter (1), then install the filter on the filter adapter and tighten the clamp.

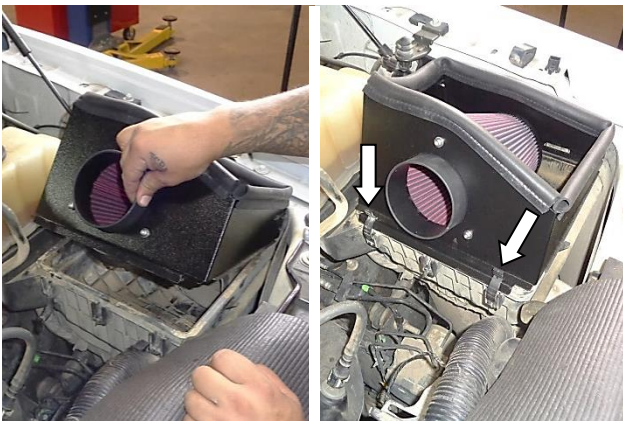

13. Insert the four tabs on the heat shield into the slots on the side of the stock airbox. Secure the heat shield to the airbox with the front and rear latches only. NOTE: The center latch will not be used, and may be removed if desired.



14. Install the grommet (12) in the intake tube (14). Then install the sensor in the grommet using the M6 screw (9). (Soapy water will ease insertion of the grommet in the tube, and the sensor in the grommet.)



15. Apply 2 wraps of nylon thread tape to the threads of the plug (13), and install it in the intake tube.



16. Slip the two small screw clamps (16) onto the 3" flex coupler (15). Slip two large screw clamps (10) onto a 4" flex coupler (11). Push each coupler onto the intake tube, and snug – do not tighten – only the tube clamps at this time. (Leave the other clamps loose.)



17. Slip the two remaining screw clamps (10) onto the other 4" flex coupler (11). Push the coupler onto the intake tube, and snug – do not tighten – only the tube clamps at this time. (Leave the other clamps loose.)



18. Install the intake tube in the vehicle, slipping the couplers over the two turbo inlets and filter adapter.



19. Push the right coupler up against the heat shield, then tighten only the filter adapter clamp at this time.

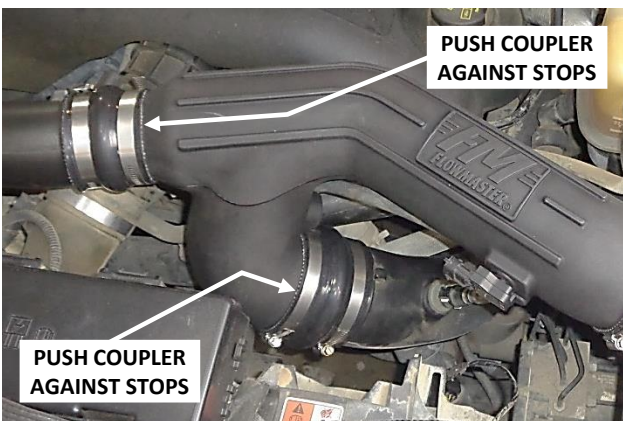

20. Push the other two couplers up against the stops on the turbo ducts and tighten the turbo duct clamps. Center the intake tube between all three couplers, so that about the same length of tube is inserted in each coupler. Then tighten the three screw clamps on the intake tube.

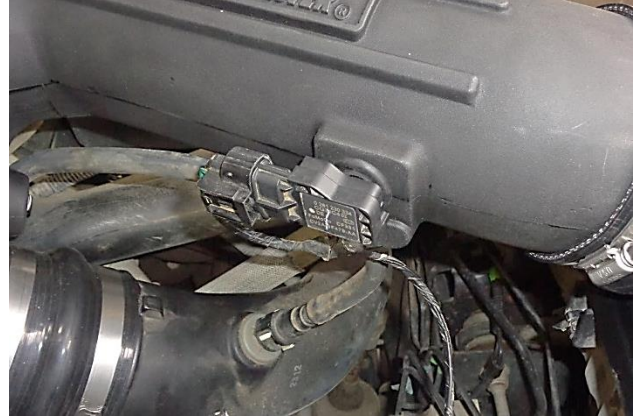

21. Push the MAF sensor plug onto the sensor until it clicks, then verify the connection is secure.



**Congratulations, the installation of your FLOWMASTER cold air intake kit is now complete!**