



Installation Instructions  
**817843**  
 2019-2022 RAM 1500  
 5.7L ENGINE  
 2/4 WD & 141, 145, 154" Wheelbases

**OVERVIEW:**

1. Take a moment to read and understand these instructions before installing your Flowmaster performance system.

**NOTE:** Please inventory all parts now before continuing and if necessary, report any missing items to our tech line. This will avoid potentially stranding your vehicle until any missing replacement parts arrive.

ITM #	PART #	DESCRIPTION	QTY.
1	26748S	Inlet Pipe	1
2	26749S	Extension Pipe	1
3	8530572-226	AMT Muffler	1
4	26729S	Right Tailpipe	1
5	26730S	Left Overaxle Pipe	1
6	26731S	Left Exit Pipe	1
7	ST462B	Tips	2

ITM #	PART #	DESCRIPTION	QTY.
N/A	PK966	Hardware Pack includes:	1
8	MC300BS	3" Stainless Band Clamp	5
9	HW211	3/8"-16 x 2 Hex Cap Screw G5	2
10	HW103	Finish Head Nut 3/8"-16 Z 5	2
11	HW303	Zinc USS 3/8" Flat Washer	2
12	HW309	Zinc 3/8" Lock Washer	2
13	HW502	3/16" Hanger Keeper	5

**REMOVE STOCK EXHAUST SYSTEM:**

2. Raise vehicle up on a hoist or rack to working height. If you don't have access to a hoist or rack, support vehicle with jack stands.

**WARNING:**  
 Avoid serious burns! Allow your vehicle time to cool completely before touching any factory engine components.

**To ease preparation and installation of your new kit:**

- Apply penetrating lubricant to mounts, bolts and clamps before you remove them.
- Use stands as necessary to support parts as you detach them from your vehicle and again as you install new parts.

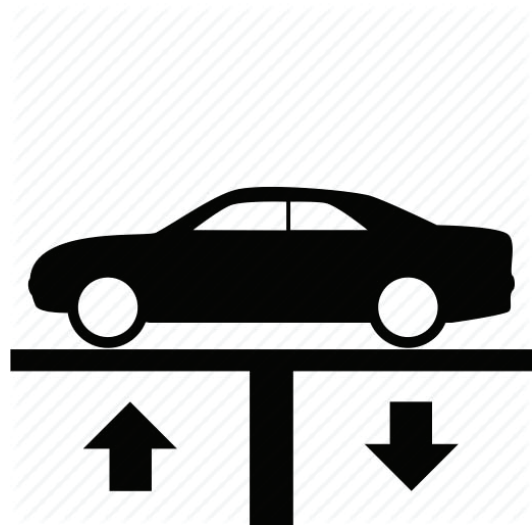

3. Remove passenger side tailpipe from vehicle by loosening clamp and dismantling wire hanger from stock mount.



4. Remove factory tailpipe from vehicle by cutting it near muffler outlet and dismantling wire hangers from factory mounts.

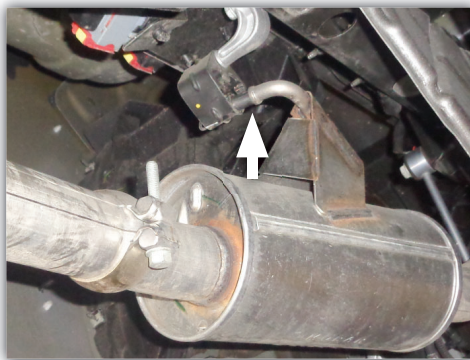

5. Remove factory muffler wire hangers (x3) from factory isolators and detach grounding wire.

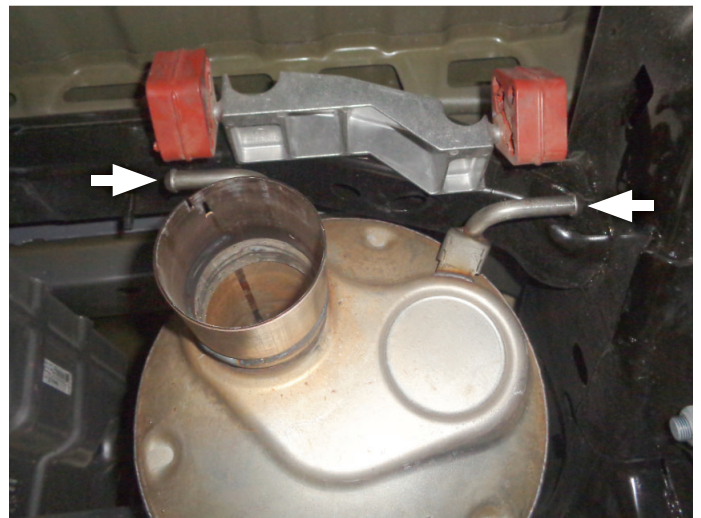

6. Remove nuts from factory pipe and catalytic converter flange. Remove muffler and factory pipe from vehicle.

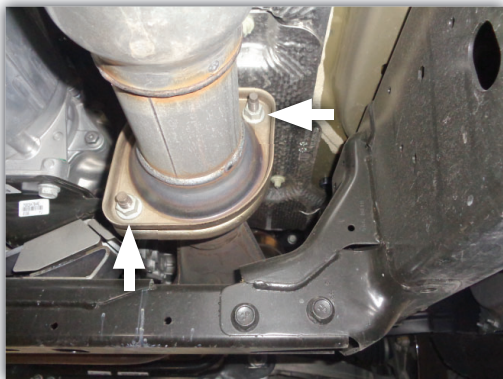

7. Remove stock studs from catalytic converter flange.



## INSTALL FLOWMASTER EXHAUST SYSTEM

8. Remove nuts from stock and Flowmaster clamps, apply anti-seize compound to threads and re-assemble.

**NOTE:** The image in this step is intended for illustration purposes only and may or may not accurately reflect components included in your kit.



9. If your vehicle falls within specifications listed below, apply corresponding modifications to ensure this kit will install properly on your vehicle. Then connect **inlet pipe (1)** to catalytic converter oriented exactly as shown.

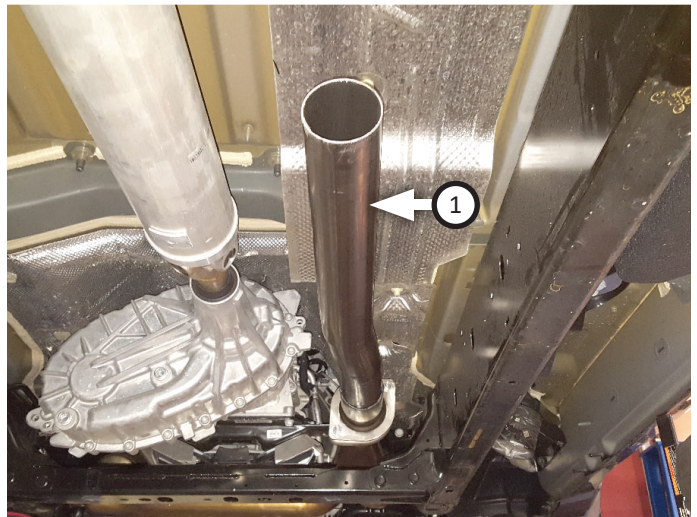

WB	BODYSTYLE	BED	INLET PIPE MODIFICATION:
154"	Crew Cab	6'4"	No modification required
145"	Crew Cab	5'7"	Trim 9" from inlet rear
141"	Quad Cab	6'4"	Trim 13" from inlet rear

10. Fasten inlet with (x2 ea) **bolts (9)**, **flat washers (11)**, **lock washers (12)** and **nuts (10)**. Place **clamp (8)** onto **extension (2)** and connect it to inlet pipe. Insert hanger in isolator then tighten clamp to allow for adjustment.

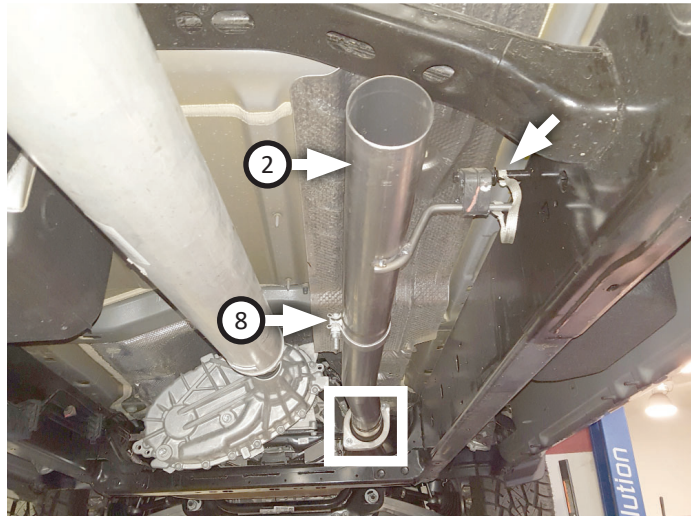
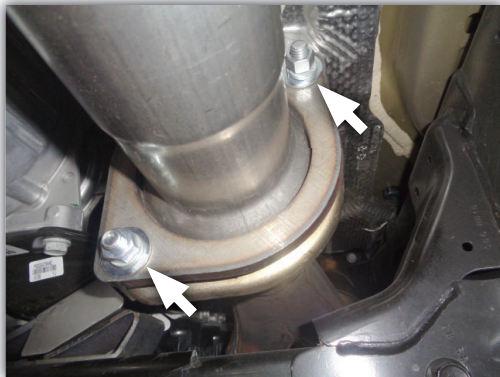

11. Connect ground wire to mount. Place **clamps (x3) (8)** on **muffler (3)** inlet and outlets, then connect muffler to extension. Tighten clamp on muffler inlet just enough to allow for adjustment.

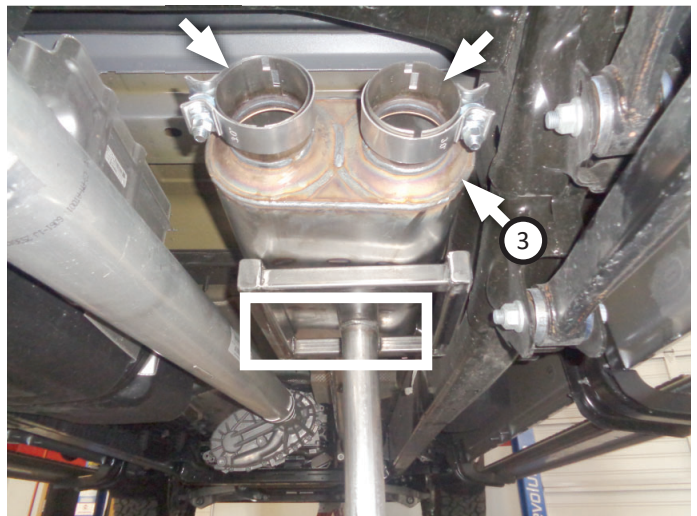
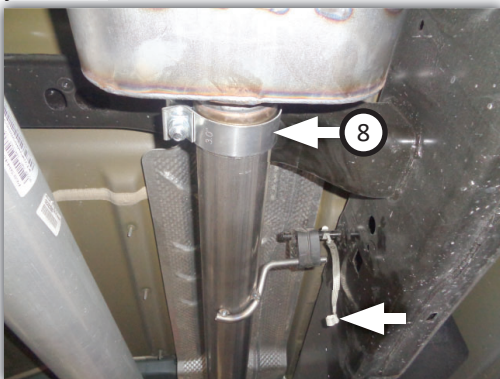

12. Thread **right tailpipe (4)** over axle and hang rear wire hanger in stock isolator. Connect right tailpipe to muffler and hang front wire hanger in stock isolator. Tighten clamp just enough to allow for adjustment.

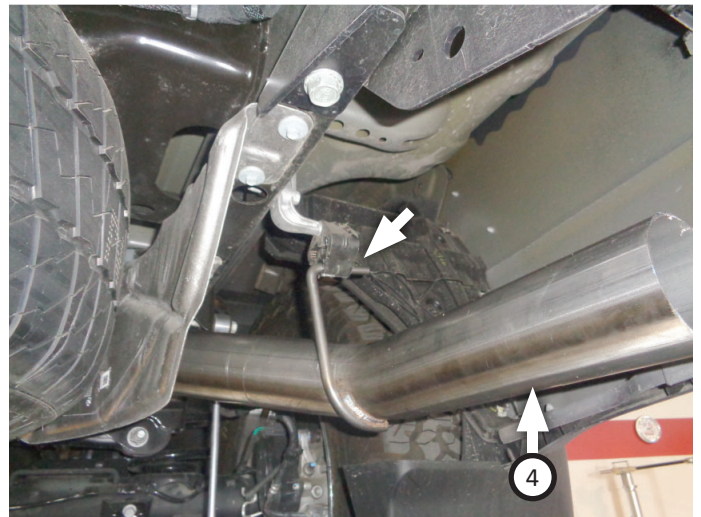
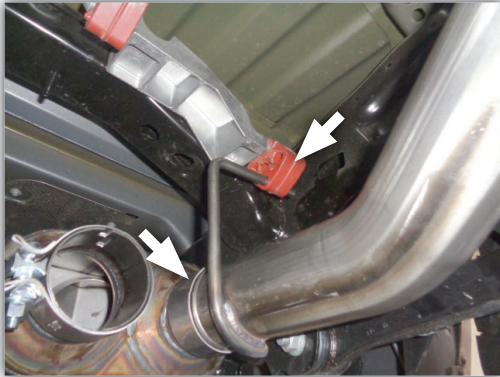

13. Connect **left overaxle pipe (5)** to muffler and hang wire hanger in stock isolator. Tighten clamp just enough to allow for adjustment.

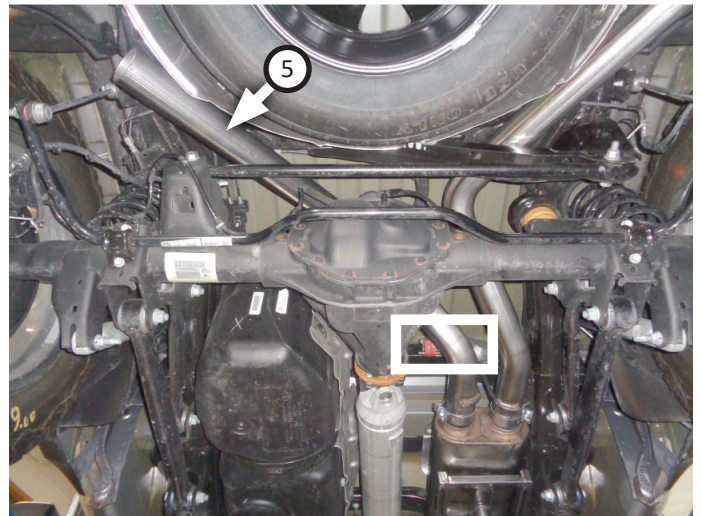

14. Place **clamp (8)** onto **left exit (6)** inlet. Connect left exit to left over-axle and hang wire hanger in stock isolator. Tighten clamp just enough to allow for adjustment.

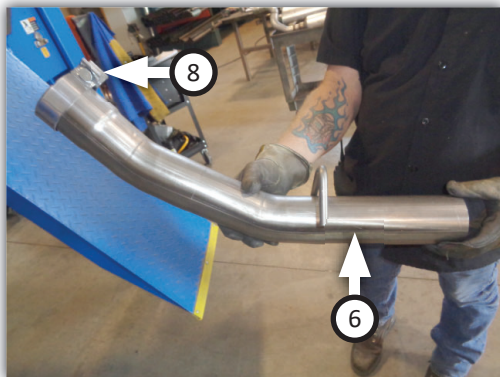

15. Place **tips (x2) (7)** onto exit tailpipes and tighten inlets. Rotate exit pipes and tips to desired distance from body or bumper, so angle cut on tips are properly positioned.

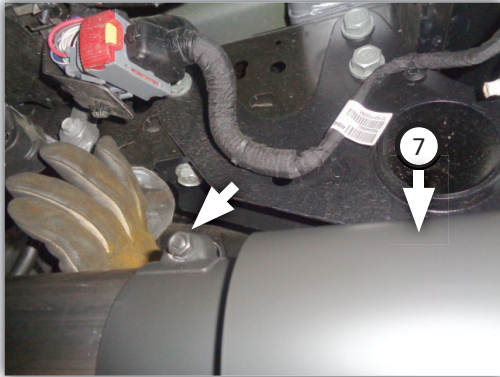

16. Adjust exhaust components for fit; maintaining  $\frac{1}{2}$ " clearance and compensating for suspension, travel and vibration. To ensure your system lines up, focus specifically on inlet pipe, ensuring it matches picture shown in step 9. Tighten all clamps then fit **hanger keepers (x5) (13)** onto each sideways hanger.
17. Recommended: Secure slip-fit connections with a 1-inch tack weld then spray high-temp paint over each weld to prevent rust and premature corrosion.



Congratulations, the installation of your FLOWMASTER performance exhaust system is now complete!





Installation Diagram  
**817843**  
2019-2022 RAM 1500  
5.7L ENGINE

2/4 WD & 141, 145, 154" Wheelbases

