



Installation Instructions

817938

**1967-72 FORD F100, 250 & 350
5.0L, 5.8L, 5.9L & 6.4L ENGINE
2WD, 115" & 131" Wheelbase
Short/Long Bed**

For trucks without factory auxiliary fuel tank.

OVERVIEW:

1. Take a moment to read and understand these instructions before installing your Flowmaster performance system.

NOTE: Please inventory all parts now before continuing and if necessary, report any missing items to our tech line. This will avoid potentially stranding your vehicle until any missing replacement parts arrive.

ITM #	PART #	DESCRIPTION	QTY.
8	86632S	R/L Side Exit Pipe	2
9	86664S	Left Dump Exit Pipe	2
10	86665S	Right Dump Exit Pipe	2
N/A	PK1034	Hardware Package includes:	1
11	MC250BS	2½" Stainless Band Clamp	8
12	MC200BS	2" Stainless Band Clamp	1
13	HA572	Rear Hanger	2
14	HA602	Front Hanger	4
15	HW204	⅝"-18 x 1 Bolt	8
16	HW102	⅝" Nut	8
17	HW302	⅝" Flat Washer	16
18	HW308	⅝" Lock Washer	8
19	HW501	⅜" Hanger Keeper	4

ITM #	PART #	DESCRIPTION	QTY.
1	86652S	R/L Inlet Pipe	2
2	86653S	Right H-Pipe	1
3	86654S	Left H-Pipe	1
4	842546-Z	Muffler	2
5	86647S	Right Tailpipe	1
6	86648S	Left Tailpipe	1
7	86649S	R/L Rear Exit Pipe	2

PREPARE VEHICLE FOR KIT INSTALLATION:

2. Raise vehicle up on a hoist or rack to working height. If you don't have access to a hoist or rack, support vehicle with jack stands.

WARNING:

Avoid serious burns! Allow your vehicle time to cool completely before touching any factory engine components.

To ease preparation and installation of your new kit:

- Apply penetrating lubricant to mounts, bolts and clamps before you remove them.
- Use stands as necessary to support parts as you detach them from your vehicle and again as you install new parts.

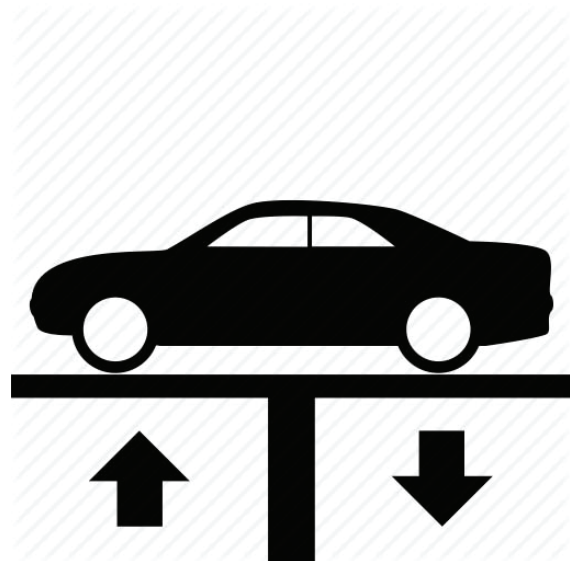

3. Remove existing system from header collector or manifold down pipes rearward.

INSTALL FLOWMASTER EXHAUST SYSTEM:

4. Remove nuts from Flowmaster clamps, apply anti-seize compound to bolts and re-install nuts.



5. Mark forward cross member on both sides, inboard 2½" from intersecting frame edge.

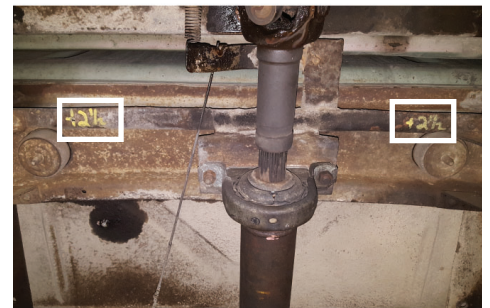
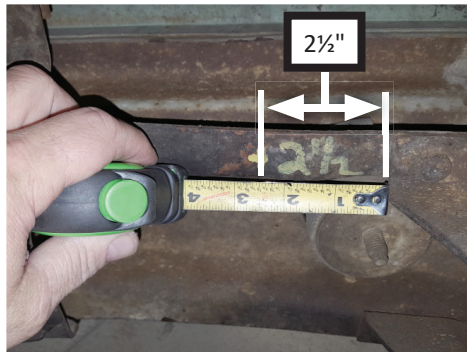
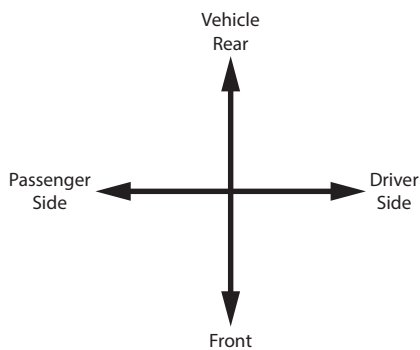

6. Use (x2) rear frame hangers (14) (oriented flanges out) to drill ⅝" mount holes then install hangers with (x2) bolts (15), (x4) flat washers (17), (x2) lock washers (18) and (x2) nuts (16).

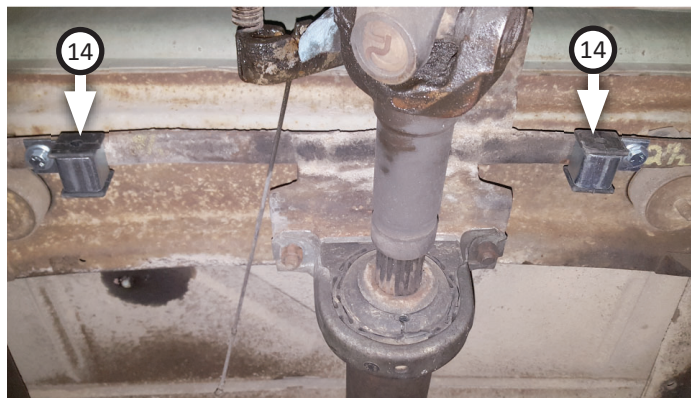

7. Mark rear cross member on both sides, inboard 4" from intersecting frame edge. Use (x2) **rear hangers (13)** oriented as shown to center then drill mount holes.



NOTE: For short bed vehicles only, trim 16" from rear of H-pipe for proper fit.

8. Assemble **left (3)** and **right (2)** H-pipe together with **clamp (12)**, then hang assembly into rear frame hangers (installed step 6) on forward cross member.

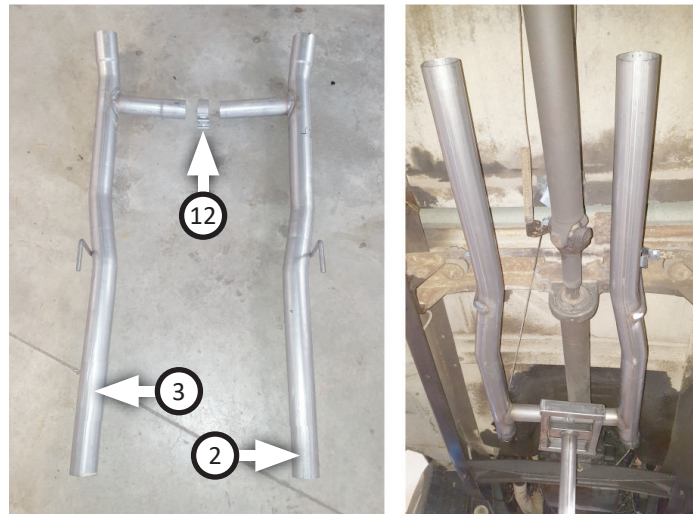

9. Place (x2 ea.) **clamps (11)** onto **mufflers (4)** then connect them to h-pipes and tighten clamps enough to allow for later adjustment.

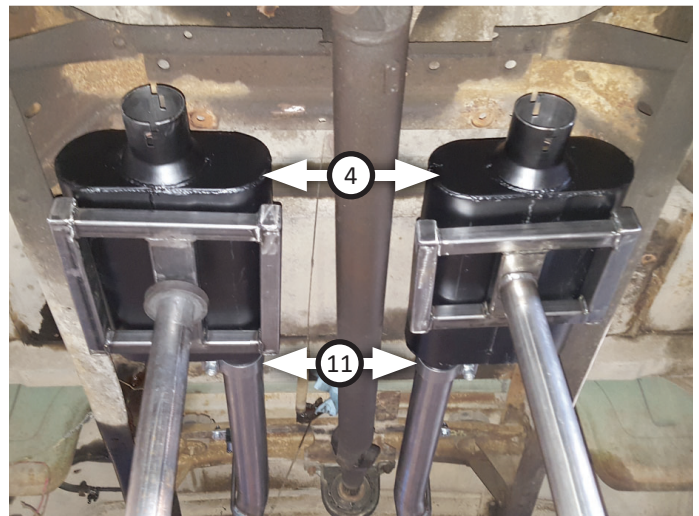

NOTE: Passenger side of frame has a pre-existing hole that simply needs to be enlarged to $\frac{5}{16}$ ".

10. Drill (x2) $\frac{5}{16}$ " holes in cross member above mufflers, placing **front hangers (14)** against frame edges as shown to locate them properly.

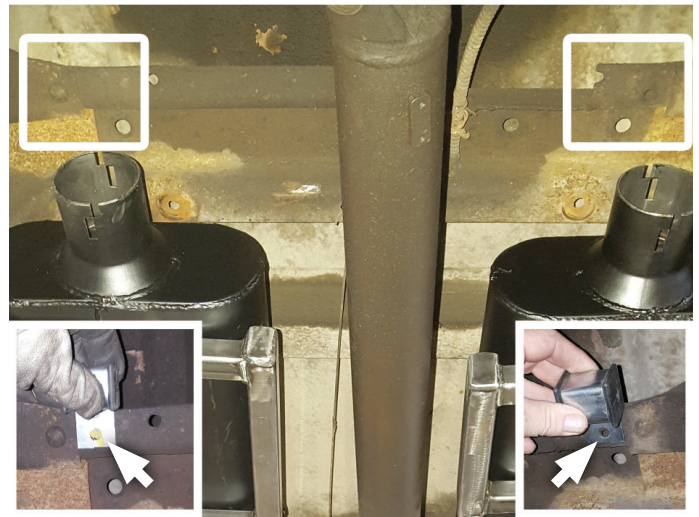

11. Set (x2) **clamps (11)** onto muffler outlets. Place (x2) rear hangers onto **right (5)** and **left (6)** tailpipes.

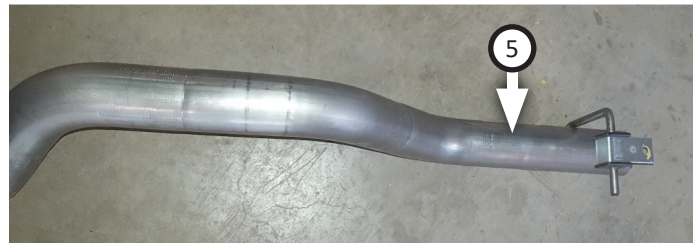
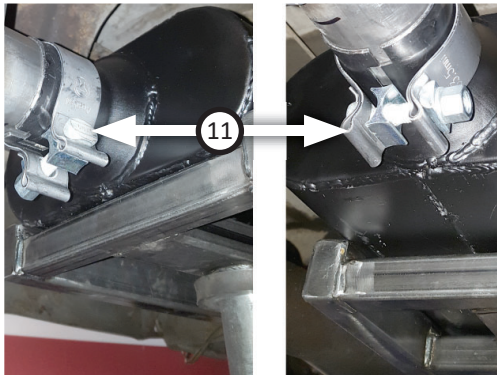

12. Fasten (x2) hangers to rear crossmember (step 7) with (x4) **bolts (15)**, (x8) **flat washers (17)**, (x4) **lock washers (18)** and (x4) **nuts (16)**. Connect left and right tailpipes to mufflers.



13. Secure (x2) front hangers (on tailpipes) to crossmember (step 10) with (x2) **bolts (15)**, (x4) **flat washers (17)**, (x2) **lock washers (18)** and (x2) **nuts (16)**.

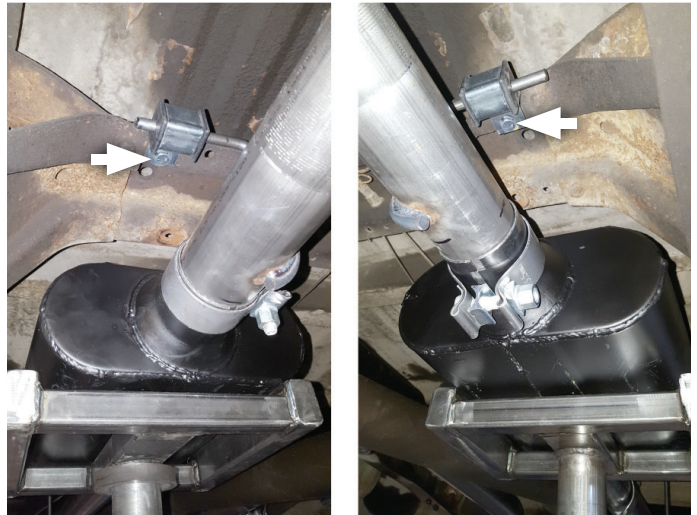

NOTE: Additional fabrication may be necessary for inlet pipes to fit your vehicle.

14. Use **right and left inlet pipes (1)**, to connect factory exhaust and h-pipes, using (x2) **clamps (11)** to secure connections.

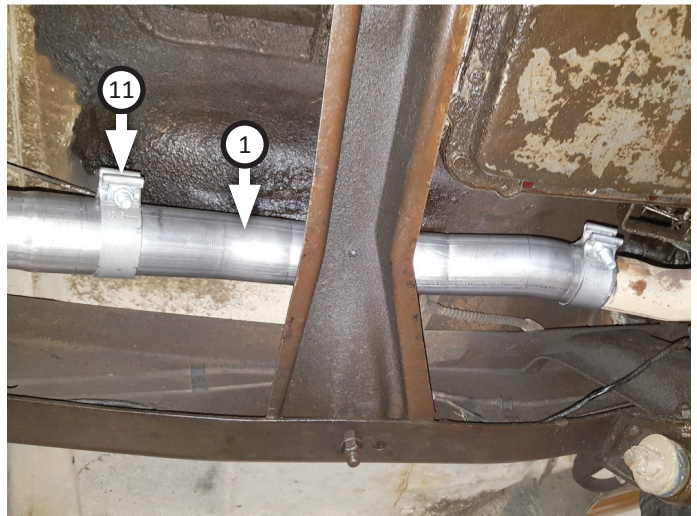

NOTE: This kit includes **rear (7)**, **side (8)** and **dump (9, 10)** exit pipes. The exit pipes are left long in order to let you decide how your exhaust should look. Choose which style you would prefer, then use corresponding parts to complete this step.

15. Place (x2) **clamps (11)** onto exit pipes and connect them to left and right tailpipes. Rotate exit pipes to desired distance from body or bumper, so they are properly positioned.

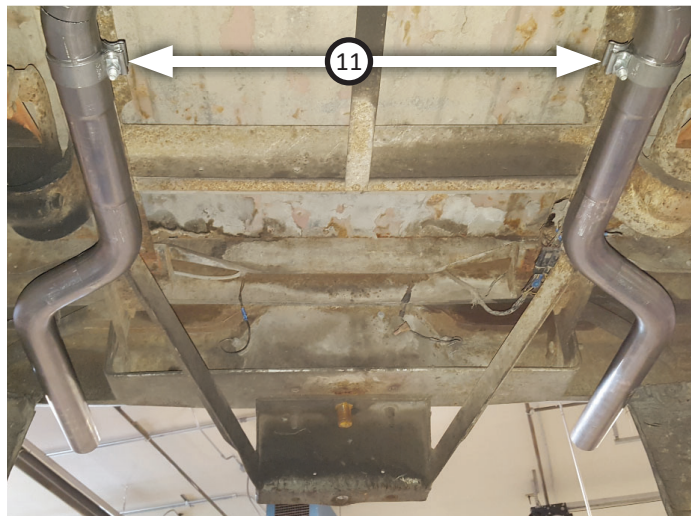

16. Adjust exhaust components for fit; maintaining ½" clearance and compensating for suspension, travel and vibration, then tighten all clamps. Finally, fit (x4) **hanger keepers (19)** onto each sideways hanger.
17. Recommended: Secure slip-fit connections with a 1-inch tack weld then spray high-temp paint over each weld to prevent rust and premature corrosion.



Congratulations, the installation of your FLOWMASTER performance exhaust system is now complete!





Installation Diagram

817938

1967-72 FORD F100, 250 & 350

5.0L, 5.8L, 5.9L & 6.4L ENGINE

2WD, 115" & 131" Wheelbase

Short/Long Bed

For trucks without factory auxiliary fuel tank.

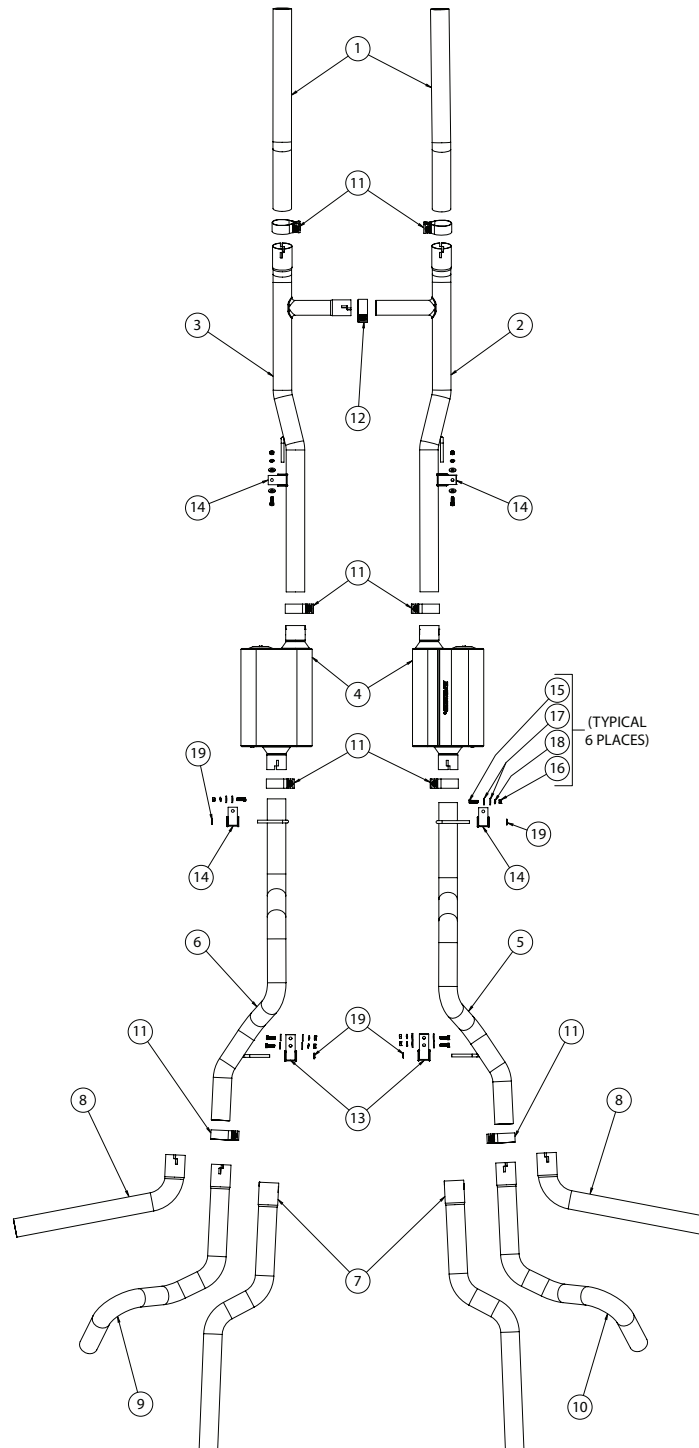



Flowmaster® Product Warranty Details

Lifetime Limited Warranty applies to Flowmaster stainless steel mufflers (excluding FlowFX series), all stainless steel exhaust systems (including FlowFX series), stainless steel pipes, air intake kits and oiled type filters (except cleaning kits), and other stainless steel exhaust accessories (except exhaust tips and racing products).

Three (3) Year Limited Warranty applies to Flowmaster aluminized steel mufflers, aluminized steel exhaust systems, aluminized steel pipes, exhaust tips and other non-race exhaust accessories.

Two (2) Year Limited Warranty applies to Delta Force Dry air intake filter elements.

One (1) Year Limited Warranty applies to FlowFX series mufflers, Elite Series exhaust headers and electronic components such as Delta Boost modules.

Flowmaster, Inc. ("Flowmaster") extends the following limited warranty to the original purchaser of its mufflers, exhaust systems, pipes, exhaust tips, headers and other non-race accessories (hereafter "products"), **excluding catalytic converters sold under the Flowmaster brand.**

Flowmaster warrants the products mentioned above against defects in materials and workmanship for the period set forth below, when they are owned by the original purchaser and remain installed on the vehicle on which they were originally installed. This warranty is void if the product was not installed properly on the vehicle, was installed on a vehicle for which it was not designed, or was removed from the vehicle on which it was originally installed and reinstalled on another vehicle. This warranty shall not apply to normal wear, including interior/exterior sound levels, cosmetic issues such as coatings and material discoloration, any product that was installed on a racing vehicle, installed improperly or contrary to Flowmaster instructions, altered, misused, repaired, damaged from an accident, collision, undercarriage road impact or debris, or willful or negligent act. Note that all "straight-through" mufflers which use sound absorbing material inside the muffler to cancel sound...will degrade over time. This degradation of sound absorbing materials is considered "normal wear"...not a material defect.

The warranty set forth herein for Flowmaster stainless steel mufflers (except FlowFX), all stainless steel exhaust systems, stainless steel pipes, stainless steel exhaust accessories (except exhaust tips) and air intake kits and oiled type filters (except cleaning kits), extends for a period of the life of the original vehicle the product was installed on. The warranty set forth herein for Flowmaster aluminized steel mufflers, aluminized steel exhaust systems, aluminized steel pipes, all exhaust tips and non-race exhaust accessories and commercial applications of aluminized steel products or stainless steel products extends for a period of three (3) years from the date of original purchase and the original vehicle it was installed on. The warranty set forth herein for Flowmaster dry air intake filter elements extends for a period of two (2) years from the date of original purchase and the original vehicle it was installed on. The warranty set forth herein for Flowmaster Exhaust headers, FlowFX mufflers, and Delta Boost modules extends for a period of one (1) year from the date of original purchase and the original vehicle it was installed on. Header warranty does not cover damages caused by exhaust insulating wrap, and is void if the product was installed on a new or rebuilt engine during the initial break-in period.

To make any claim under the terms of this limited warranty, the original purchaser **MUST** either return the product to the original retailer or directly to Flowmaster. If the original purchaser elects to return the product to Flowmaster directly, he or she must first contact Flowmaster and obtain a Returned Material Authorization (RMA) number. Once the RMA number is received, the original purchaser may return the product to the address provided by Flowmaster, along with the **RMA number and Proof of Purchase** of the covered product. The Proof of Purchase must clearly show the place of purchase, purchase price, product purchased, and date of purchase. If upon inspection by Flowmaster the product is found to be defective in material or workmanship, Flowmaster shall at its option, either exchange the product for new product with the same part number or refund the original purchase price.

This warranty is not contingent upon the purchaser's completion of the Warranty Registration Form found on the Flowmaster website. If however the purchaser completes and submits that form at the time of purchase, Flowmaster will keep that form on file which may serve as an aid in determining warranty coverage in the event of the loss of the original purchase receipt.

Flowmaster's liability is expressly limited to the replacement of the product or refund of the purchase price as described herein. Flowmaster shall have no liability for the cost of installation or removal of the defective product, the cost of labor or any additional parts required to complete the installation of the replacement product, towing or transportation costs, or return shipping costs. In no event shall Flowmaster be liable for any direct, indirect, special, incidental or consequential losses and/or damages, including but not limited to interruption of business or loss of business or loss of profit or damage to related components resulting from the use of or inability to use the product, or any breach of warranty or any defect in the product, even if Flowmaster shall have been advised of the possibility of such potential losses or damages. Some states do not allow the exclusion or limitation of incidental or consequential damages, so the above limitation or exclusion may not apply to you. This warranty gives you specific legal rights. You may also have other rights which may vary from state to state.

The warranties set forth herein are exclusive and unless otherwise required by applicable law no other warranties are made by Flowmaster or are authorized to be made with respect to the product.

Rev. 2/5/18