

Holley® iNTECH

2018 Jeep Wrangler JL V6, 3.6L Intech Cold Air Intake System

223-16

Installation Instructions



Thank you for making HOLLEY iNTECH COLD AIR INTAKES your choice in a high-performance air intake system. Extensive dyno/track testing has enabled HOLLEY to offer the most advanced design in sealed air intake systems. HOLLEY iNTECH's patented interface allows for an easy and seamless installation, moreover, results will show additional horsepower, reduced air intake temperature and improved performance. Proper installation and maintenance will ensure long life and maximum performance from your HOLLEY iNTECH COLD AIR INTAKE. Visit PATENTS.HOLLEY.COM for more information.

BEFORE STARTING:

Ensure that the engine is cold and has not been run for a minimum of 2 hours prior to install.

INCLUDED HARDWARE:

P/N	Qty.	Description
223-16A	1	Tube
223-16H	1	Housing
61R940	1	Coupling, Silicone, Hump 3.00"ID x 2.38" L
53R293	1	Grommet, Rubber
711R1	1	Fitting, Temp Sensor
80R154	1	Air Filter
19R1037	1	Fitting, CCV Vent, 1/2" NPT
557R14	2	Clamp, Worm, 304SS # 52 2.81"-3.75"
99R10460	2	Decal, Intech 5" x 1.5", Die Cut Special
217R3	1	Cable Tie W/Retainer
217R5	1	Cable Tie, 8.3"

Check the hardware package. If anything is missing, please contact Technical Service at 1-866-464-6553 or 270-781-9741.

INSTALLATION:

1. Disconnect the negative cable from the vehicle battery.
2. Disconnect the crankcase vent (CCV) fitting from the OE air intake tube (**Figure 1**).
3. Disconnect the (x3) cable tie retainers from the air intake temp sensor harness and the coolant overflow line from the OE air intake sound tube chamber. These can be removed (**Figure 1**).
4. Disconnect air intake temp sensor connector (**Figure 1**).



Figure 1

5. Remove the (x2) bolts securing the OE intake tube to the radiator shroud. (**Figure 2**).
6. Loosen the (x2) hose clamps securing the intake tube to the throttle body and OE air box. Remove intake tube (**Figure 2**).

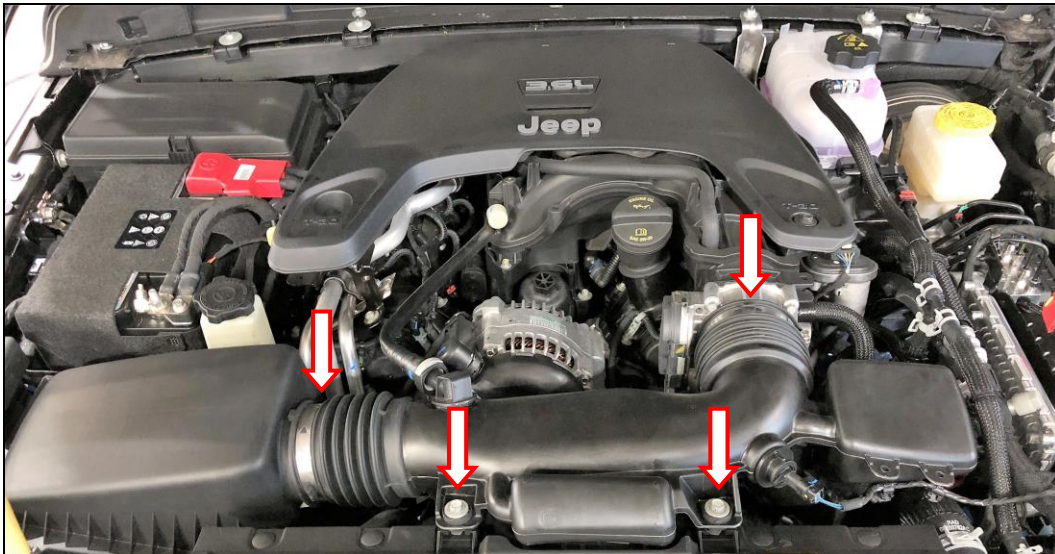

Figure 2

- Remove the remaining screw securing the OE air box and air scoop to the vehicle fender (**Figure 3**). Remove air box and scoop assembly from vehicle. Be careful not to lose the (x2) rubber grommets securing the bottom of the air box as they will be reused.

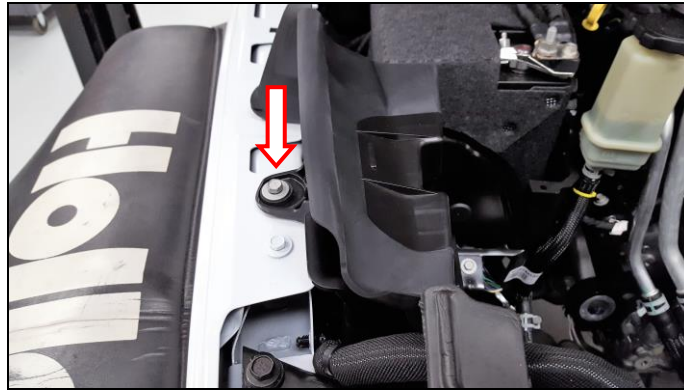

Figure 3

- Remove the screw securing the OE scoop to air box. Reinstall scoop with factory screw to INTECH housing.
- On a workbench, install the INTECH Air Filter until the air filter completely engages and bottoms out on the grooved interface.
- While aligning the seal on the OE scoop against the fender, install the scoop and housing assembly into the vehicle (if necessary, disconnect gray wiring connector during installation to avoid damage to connector or housing **Figure 4**). The INTECH housing studs should be seated in to the factory grommets on the housing mount (**Figure 5**).

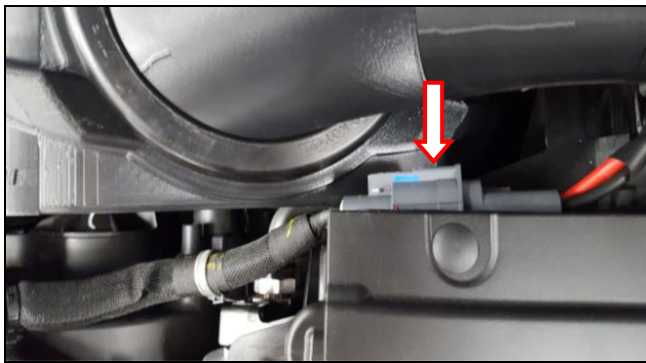

Figure 4

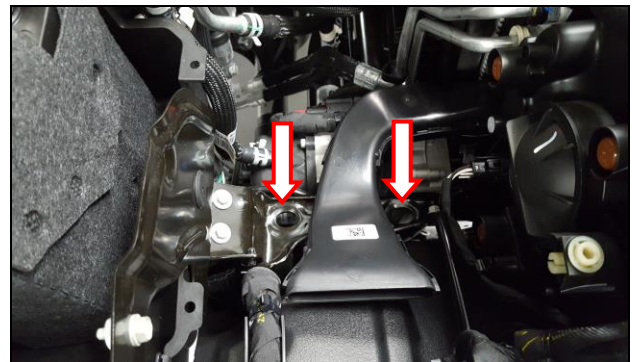

Figure 5

- Verify clearance between housing and power steering reservoir. If necessary, loosen reservoir bolt, push reservoir towards the rear of the vehicle, and retighten (**Figure 6**).



Figure 6

12. Using the supplied aluminum NPT vent fitting, secure onto the INTECH Intake Tube and tighten (**Figure 7**).
13. Remove (x2) rubber grommets from OE tube and reinstall in INTECH tube (**Figure 7**).
14. Install supplied grommet and air temp sensor fitting into the INTECH tube. **NOTE: Aluminum temp sensor fitting has an alignment dimple that when properly installed, should be facing up to align with marker on tube (Figure 8).** Soap and water or equivalent will help with this process.

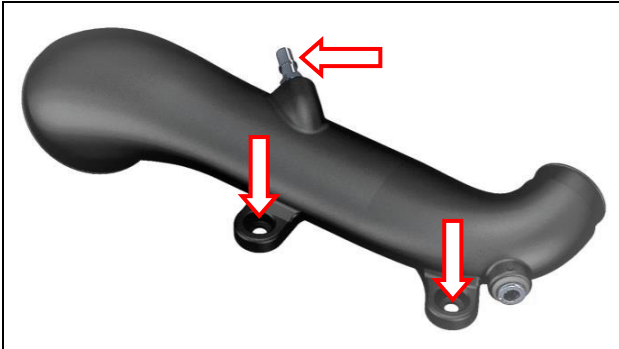

Figure 7

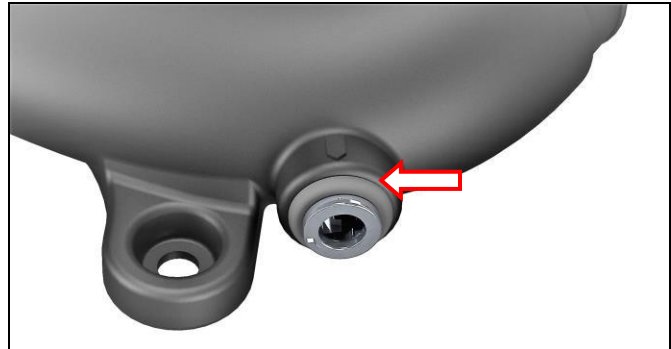

Figure 8

15. Remove air intake temp sensor from OE intake tube by lightly lifting up on position tab with a screwdriver (or equivalent), rotating counterclockwise, and pulling out. **Be careful not to use too much pressure prying on sensor tab (Figure 9).**

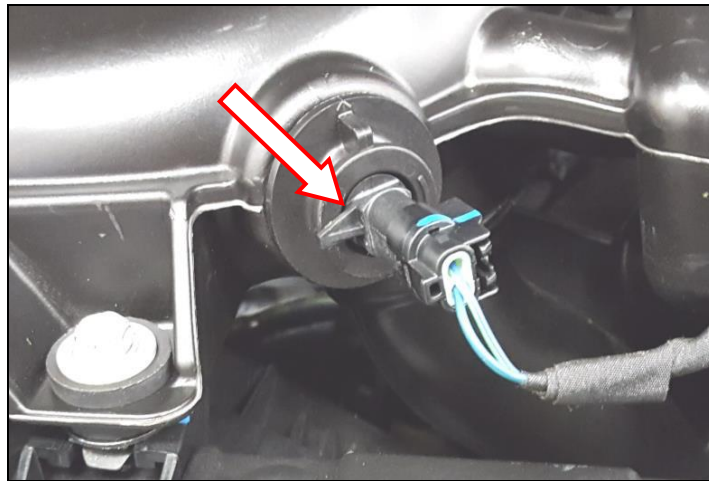

Figure 9

16. Reinstall temp sensor into INTECH intake tube fitting making sure position tab on sensor is turned clockwise far enough to engage in lock on fitting.
17. Install the silicone coupling and (x1) provided clamp to the throttle body.
18. Install the intake tube into the air filter until you feel a 'lock'. **NOTE: Soap and water (or equivalent) will help with inserting the tube into the filter.** Then, rotate and align the tube with the throttle body and coupling. Insert tube into the silicone coupling. Install the remaining clamp and tighten.
19. Reinstall (x2) OE bolts securing the intake tube to the radiator shroud.

20. Reconnect the CCV tube and temp sensor connector (**Figure 10**).
21. Remove (x1) OE radiator seal retainer from the outside of the fan shroud. Secure temp sensor harness with supplied cable tie with retainer using the open hole in fan shroud (**Figure 10**).
22. Secure coolant overflow hose using supplied cable tie (**Figure 10**).



Figure 10

23. Connect the battery and re-check your work.

LIMITATION OF LIABILITY – DISCLAIMER:

The regulation of emissions production, noise levels, and safety standards is undertaken by the federal government, each of the fifty state legislatures, and by many local municipalities, towns, and counties.

HOLLEY INTECH makes no warranties of merchantability, of fitness for particular purpose, or that its products are approved for general use, or that its products comply with laws, regulations, or ordinances in the state where they may be sold to the ultimate purchaser, the consumer.

Unless expressly stated to the contrary in the catalog, instruction sheet; or price list, the entire risk as to the conformity of any company product in any such state and as to repair should the product prove to be defective or non-conforming, is on the retail purchaser, the buyer, the ultimate consumer, of such product and it is not upon the seller, distributor, or manufacturer.

In this connection, the retail purchaser, the buyer, the ultimate consumer assumes the burden of the entire cost of any and all necessary service, alterations, or repair.

THE FOREGOING STATEMENT LIMITS THE LIABILITY OF THE MANUFACTURER.

California vehicle code, sections 27156 and 38391, prohibits the advertising, offering for sale, or installation of any device, which modifies a vehicle's emission control system, unless exempted, unless otherwise noted. HOLLEY INTECH that has not received an Executive Order (E.O.) exemption from these code sections are not legal for sale or use in California on vehicles originally equipped with catalytic converters, except for racing vehicles, which may never be driven upon a highway. Check with your local authorities to determine if these headers are legal for use in your particular area.

© 2018 INTECH, Inc. All rights reserved. Tous Droits Réservés.

Protected by one or more US Patents. See patents.holley.com.

199R11649

Revision Date: 2-26-19