



Note: These kits are not legal for use on pollution controlled vehicles

Instruction Manual

for the following Go EFI Systems

30001, 30002, 30004, 30012, 30061, 30062 & 30064



WARNING: Cancer and Reproductive Harm - www.P65Warnings.ca.gov.

This Quick Start Manual is designed to get you up and running with the Go EFI System Base Kit and either the 40003 Fuel Command Center or the 40005 Inline Fuel Delivery Kit. The FiTech Go EFI System is the industry's most advanced throttle body EFI system and also the easiest to install. It includes a very advanced Handheld Controller but is also capable of being far more tunable than

any competitive product that utilizes a Handheld Controller. Please read the full instruction manual before beginning your installation.

These instructions cover the Basic Kit installation and setup as well as instructions for both of the optional Fuel Delivery Kits. **For technical assistance with your Go EFI System, call 951-340-2624.**

Warning: Caution must be observed when installing any product involving fuel system parts or gas tank modifications. Work in a well ventilated area with an approved fire extinguisher readily available. Eye goggles and other safety apparel should be worn to protect against debris and sprayed gasoline. We recommend having this installation performed by an experienced qualified automotive technician. The finished installation must be thoroughly checked for any fuel system leaks. All safety precautions must be observed when working with fuel. **Note: Do not use solid core ignition wires.**

- 30001/30002/30004/30012/30061/30062/30064 Kit Contents**
- (1) 4-Injector Throttle Body - Tumbled Polished (30001) or,
 - (1) 4-Injector Throttle Body - Matte Black Finish (30002) or,
 - (1) 4-Injector Throttle Body - Matte Black Finish (30004) or,
 - (1) 8-Injector Throttle Body - Matte Black Finish (30012) or,
 - (2) 4-injector Throttle Bodies - Tumbled Polished (30061) or,
 - (2) 4-injector Throttle Bodies - Matte Black Finish (30062) or,
 - (2) 4-injector Throttle Bodies - Matte Black Finish (30064)
 - (1) Harness "A" (Plug-in pigtail user harness)
 - (1) ECU (Mounted on Throttle Body)
 - (1) Set of four or eight injectors pre-installed
 - (1) Idle Air Control (Installed on Throttle Body)
 - (1) Throttle Position Sensor (Mounted on Throttle Body)
 - (1) Coolant Sensor
 - (1) Handheld Controller w/billet case
 - (1) Wide Band O₂ Sensor
 - (1) O₂ Sensor Bung Kit
 - (1) Fuel Pressure Regulator (Installed in Throttle Body)
 - (1) Gasket Kit
 - (2) -06 AN Inlet/Outlet Fittings (Installed on Throttle Body)
 - (3) Inlet/Outlet Port Plugs (Two installed on Throttle Body)
 - (1) Data Com Cable
 - (1) 8 gigabyte SD Card (Installed in Controller)
 - (1) 3/8-NPT Reducer
 - (1) 10mm Port Plug
 - (1) Instruction Booklet

Table of Contents for Instruction Manual:

Kit Contents.....	1	Wiring the EFI System.....	5
About your FiTech Go EFI System.....	2	Fan Circuit Wiring.....	5
Fuel Delivery Requirements.....	2/3	Wiring Chart.....	10
Oxygen Sensor Installation.....	3/4	Wiring Schematics.....	7 thru 11
Throttle Body Installation.....	4		
Coolant Temperature Sensor Installation.....	4		

About your FiTech Go EFI System

The Fitech Go EFI System will bolt directly to any 4-BBL intake manifold. To fit on a spread bore 4-BBL manifold will require an inexpensive adapter plate to avoid leaks. Note that the FiTech throttle body will bolt directly to a spread bore 4-BBL manifold but may leak without the

adapter plate. Suitable adapter plates are available from several suppliers such as Summit Racing (SUM-G1420).

The Fitech Go EFI System is self tuning once the simple initial setup is performed using the Handheld Controller. When the necessary initial inputs are made with the Hand-

held Controller the Go EFI System creates a base fuel MAP to get the engine running. Then the self tuning programming will fine tune the MAP to produce optimum power and performance. Through the use of a wide band O₂ sensor the system can continuously make adjustments in the fuel delivery to provide the correct air/fuel ratio under all climate and altitude conditions.

The ECU (computer) is mounted on the throttle body thus eliminating the necessity of remote mounting the ECU module and the need for an unsightly harness draped over your engine. Several sensors are also integral to the throttle body assembly including the throttle position sensor (TPS), manifold absolute pressure (MAP), intake air temperature (IAT), and a fuel pressure sensor.

Initial Programming: This simple procedure is performed using the Handheld Controller. A laptop computer is not required. This unit plugs into the throttle body ECU. After a few initial inputs are made the Handheld Controller can be removed or left connected. When connected, there is a dashboard and gauges screen that will show engine parameters in real time.

Fuel Delivery Systems: You may have chosen one of the two optional Fuel Delivery System Kits from FiTech. Instructions come with each kit. If using other fuel delivery components you must use a 30-micron filter ahead of the fuel inlet fitting on the Fitech throttle body.

Wide Band O₂ Sensor: This is the key component of any EFI system. Only one sensor is required. This sensor continuously monitors the exhaust gas mixture and sends the information to the ECU where adjustments are con-

Fuel Delivery Requirements

FiTech offers two different fuel delivery options. One is the 40004 Fuel Command Center 2. When using this option, you can configure the system to operate on a returnless basis from the throttle body. The other fuel delivery system is the 50001 Frame Mount Inline External Pump. Using this pump the system must have a return line. The Fuel Command Center 2 uses your existing carbureted fuel pump and fuel lines to deliver the fuel to the Command Center 2 which is mounted in the engine compartment. The only plumbing required is from the Center to the EFI.

High pressure hose and fittings are supplied with this kit to plumb from the Command Center 2 to the EFI throttle body. A 340 L/PH EFI pump is submerged in the fuel in the Command Center 2 sump tank. The Center also has a regulator and fuel pressure gauges.

When using the 30001/30002 Go EFI kits, the Command Center 2 is suitable for engines making from 200₂

stantly made to maintain the air/fuel targets.

Trigger Tach Signal: The FiTech EFI requires an rpm/trigger reference to operate. This is obtained by a connection to the negative post on a 12V coil. On HEI distributors, this connection is made to the "Tach" terminal that is indicated on the HEI distributor cap.

Timing Control: Timing Control, or "spark control" as it is sometimes called, is available on the Go EFI System. Unlike most systems, an external CDI ignition box is not required. In fact, the Go System is the only throttle body EFI with a throttle body mounted ECU that has timing control without the need for an external CDI box. This is a savings of at least \$200. The advance mechanism of the distributor used must be locked out. Settings are available for idle timing, as well as complete timing control using your Handheld Controller.

Rev Limiter: The Go EFI System provides both spark and a fuel controlled rev limiter. When the engine attains the programmed rpm limit, fuel will be cut off to maintain the desired limit. Any external ignition related rpm limiter is independent of the Go EFI System limit.

Power Adders: The Power Adder units are designed to operate in conjunction with wet nitrous systems as well as draw-thru or blow-thru superchargers or turbochargers. The Handheld Controller includes a program for nitrous that allows you to set a target air/fuel ratio when the nitrous is activated plus you can retard the timing (when timing control is active). Nitrous systems require their own fuel pump to supply the added fuel required with nitrous. There is a target air/fuel ratio setting when operating under boost with forced induction applications.

to 600 HP. Either fuel delivery system can be used with these EFI systems. When using the 8-injector 30012 Go EFI System and the Fuel Command Center 2, the system is suitable for engines making up to 800 HP. When combining the 30012 Go EFI System with the 50001 Inline Pump, it is suitable for engines up to 600 HP.

Note: If you have elected to use the Fuel Command Center 2 and your vehicle currently has a high pressure fuel injection pump, it must be replaced with a low pressure carbureted style pump. Note that vehicles equipped with factory high pressure EFI pumps are not compatible with the Fuel Command Center 2.

If you choose to use some other fuel delivery system other than FiTech, it is important to make sure that you confirm its compatibility with the FiTech EFI system. Contact the FiTech technical staff to check compatibility. Failure to do so can void your warranty.

Note the following special instructions:

- We recommend using the Fuel Command Center 2 for all installations. A submerged pump is quieter and lasts longer.
- If using the Frame Mount Inline Fuel Pump, it should be mounted as close to the fuel tank as possible and also as low as possible. It should be within two to three feet of the tank. This type of pump is designed to pump, not draw, and works best when gravity fed.
- Only use hard fuel lines when using proper EFI rated flared fittings. Make sure that you remove ALL low pressure flex joints on factory fuel lines and replace them with EFI rated fuel hose and use proper flared connections and clamps. Be careful not to mix 45° and 37° AN fittings, they look similar but will not work together. 45° fittings

usually come from a hardware store or auto parts store while 37° AN fittings are the ones supplied by Fitech and most speed shops. Remember that your system will be running at 58 PSI so consult a professional if you are not certain about this portion of your installation. Fitech does not recommend aluminum fuel lines EVER! Or you can use the supplied EFI high pressure fuel hose that is supplied in your Fuel Delivery Kit.

VERY IMPORTANT NOTE: Your fuel tank must have a vent to prevent pressure building up inside the tank.

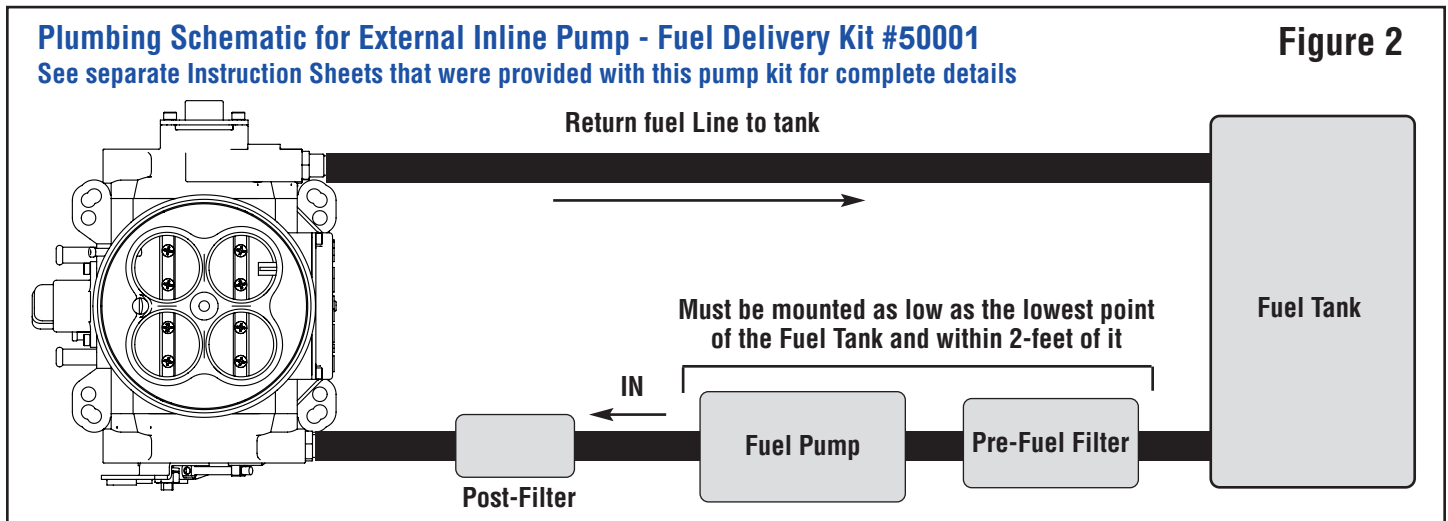
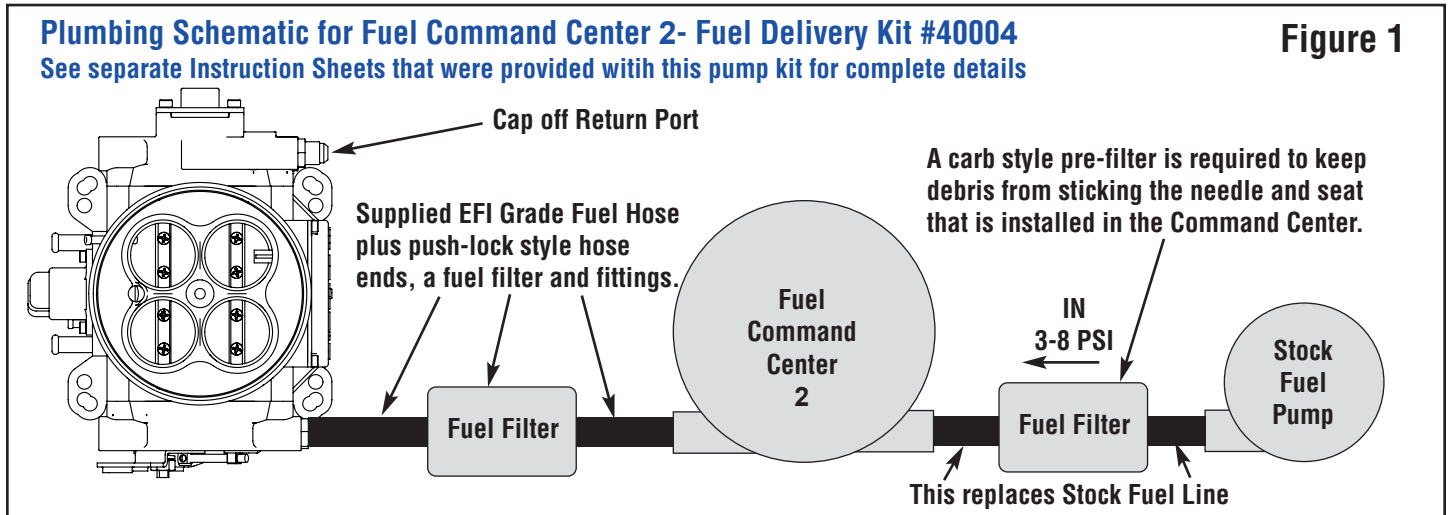

Note: Before starting any installation, disconnect the ground connection on the battery. Be very careful when disconnecting any fuel lines to let the fuel drain into a receptacle or a dry cloth. Do not allow raw fuel to collect on the engine as this is a fire hazard. Please observe extreme caution when working with the fuel system.

Oxygen Sensor Installation

The supplied O₂ Sensor can be installed in either exhaust bank. The Sensor cable connects to one of the cables coming out of the ECU on the throttle body.

- A. The ideal location for the Sensor is 2-4 inches after the exhaust collector. It must always be at least 18-inches from the exhaust tip. Where short or open headers are utilized, install the sensor in the primary tube of the rear

usually come from a hardware store or auto parts store while 37° AN fittings are the ones supplied by Fitech and most speed shops. Remember that your system will be running at 58 PSI so consult a professional if you are not certain about this portion of your installation. Fitech does not recommend aluminum fuel lines EVER! Or you can use the supplied EFI high pressure fuel hose that is supplied in your Fuel Delivery Kit.

cylinder. Must be at least 8-inches from the exhaust port. It will not work on "zoomie" style headers.

- B. The sensor should be at least 10° above horizontal (see figure #3) to allow condensation to run off. If this is not adhered to, the sensor is susceptible to water damage.
- C. Never position the sensor on the outside of a bend in the tubing.

D. The sensor must always be mounted ahead of any catalytic converter if so equipped.

E. Drill a 7/8" diameter hole in the desired location.

F. The supplied bung kit can either be welded in place or clamped onto the pipe. The clamp-on style works well and will not leak. If welded, make sure the bung is welded completely all the way around and does not leak.

G. Install the sensor into the bung. **WARNING:** Do not start the engine without the sensor cable connected to the throttle body and the EFI system is fully operational or damage will occur to the sensor.

AIR LEAKS: It is important that no air leaks exist anywhere in the exhaust system between the sensor and the engine. Any exhaust leaks will cause the unit to receive

Throttle Body Installation

Installing the throttle body is no different than replacing the carburetor. Disconnect the throttle linkage and the fuel line. Remove the existing carburetor from the intake manifold. Clean the gasket surface of the manifold.

Vacuum Ports: Before installing the throttle body determine the engine's need for vacuum accessories. The FiTech throttle body has five vacuum ports including ported and manifold. These ports cover accessories such as power brakes. There are three 3/16" male nipples and two 3/8" male nipple. If you need more vacuum connections than this, you can purchase vacuum tees and vacuum hose at your local auto parts store. See Figures 4, 5, and 6 for location and use of various vacuum nipples.

Throttle Body Installation:

Place the supplied gasket onto the manifold and place the throttle body onto the gasket. The throttle body linkage must be on the driver's side of the engine. Install the original nuts and washers onto the four carburetor studs. Tighten to 16 lb. ft. of torque.

The FiTech throttle body has four fuel ports. Three inlet and one return. Any one of three can be the inlet. The outlet port is marked with the word "Return." On a returnless setup the outlet port is plugged. Three plugs are provided

Coolant Temperature Sensor Installation

The Temperature Sensor should be threaded into one of the ports in the intake manifold or cylinder head. The sensor threads are 3/8-NPT. Some manifolds have 1/2-NPT ports and in this instance use supplied pipe reducer. Con-

nect the Yellow/Black wire lead from the throttle body to the sensor. Snap the connector into the sensor. Use Teflon tape or a quality pipe sealant on both the pipe reducer (if used) and on the temperature sensor. false readings. This will lead to poor engine performance, including misfires, and the inability to properly auto-tune the EFI. Continued running of the system with an exhaust leak can create detonation and possible severe engine damage. Incorrect installation of the sensor, exhaust leaks, and any resulting damage is not covered by the FiTech manufacturer's warranty. Make sure your exhaust is leak-free. This is very important.

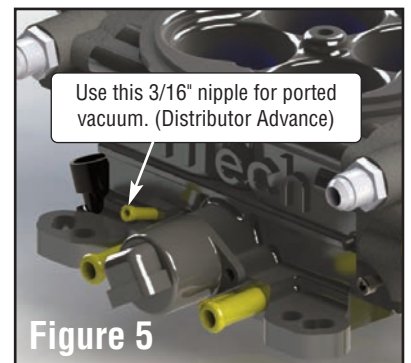
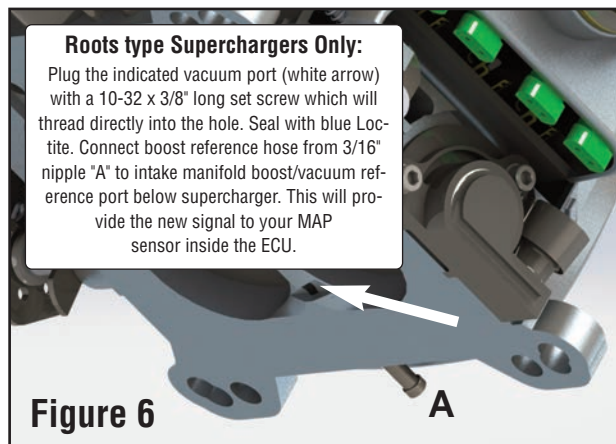
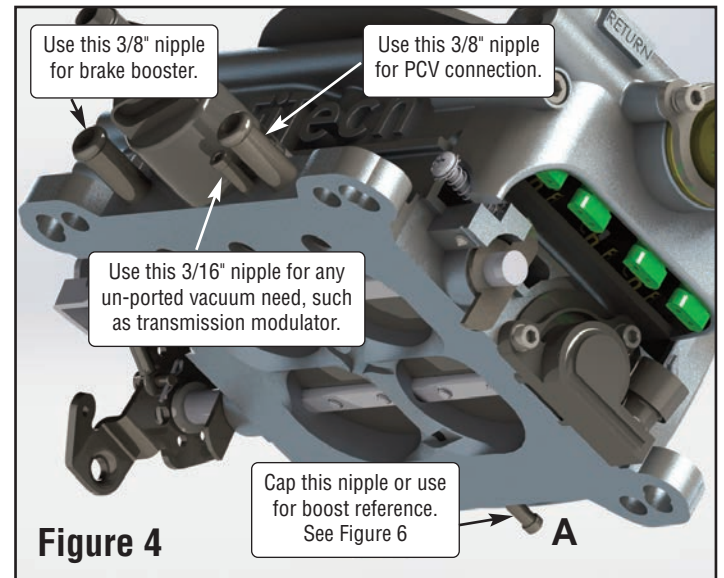
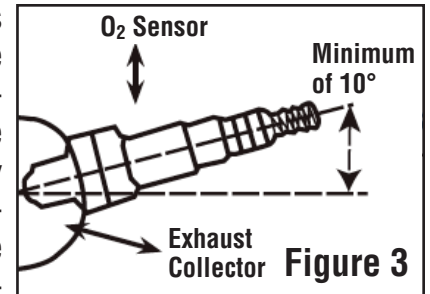

in the kit for the unused ports. Two plugs are installed in the throttle body with one loose one in the kit. All three plugs will be used on returnless configurations and only two will be used when the system will have a return line.

nect the Yellow/Black wire lead from the throttle body to the sensor. Snap the connector into the sensor. Use Teflon tape or a quality pipe sealant on both the pipe reducer (if used) and on the temperature sensor.

Wiring the EFI System

The supplied Harness "A" (see Figure 7) plugs into mating Connector "B" from the throttle body mounted ECU. See Figure 8. The various wires will need to be extended to make required connections. See the Wire Chart on page 6 which lists each wire used in the system and what it connects to. It is strongly suggested that any wire extensions are made with the same gauge and color wire as is used in the supplied Harness. Make connections as a soldered joint rather than as a crimped connection. Utilize a shrink wrapped sleeve covering all connections.

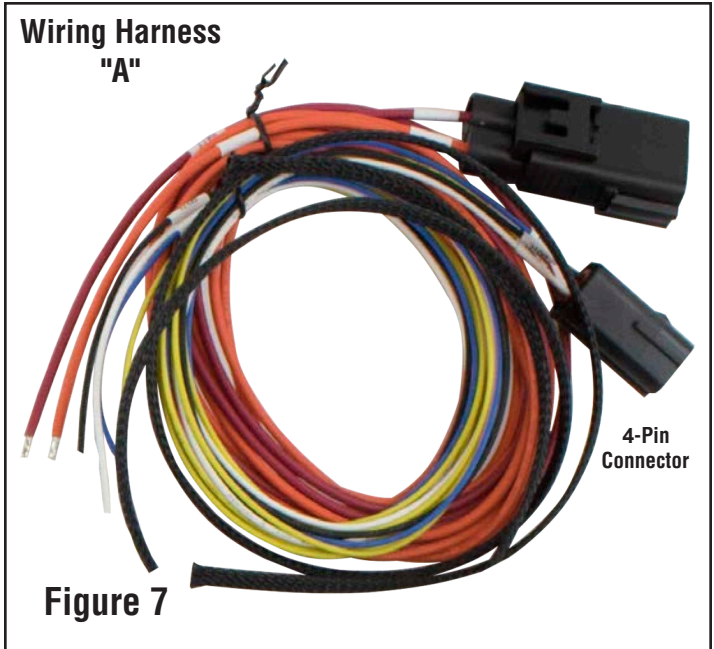
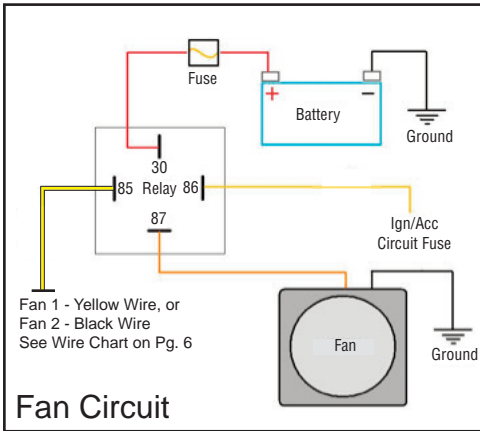

Harness "A" plugs into connector "B" from throttle body mounted ECU. See Figure 8 and page 6 Wiring Chart.

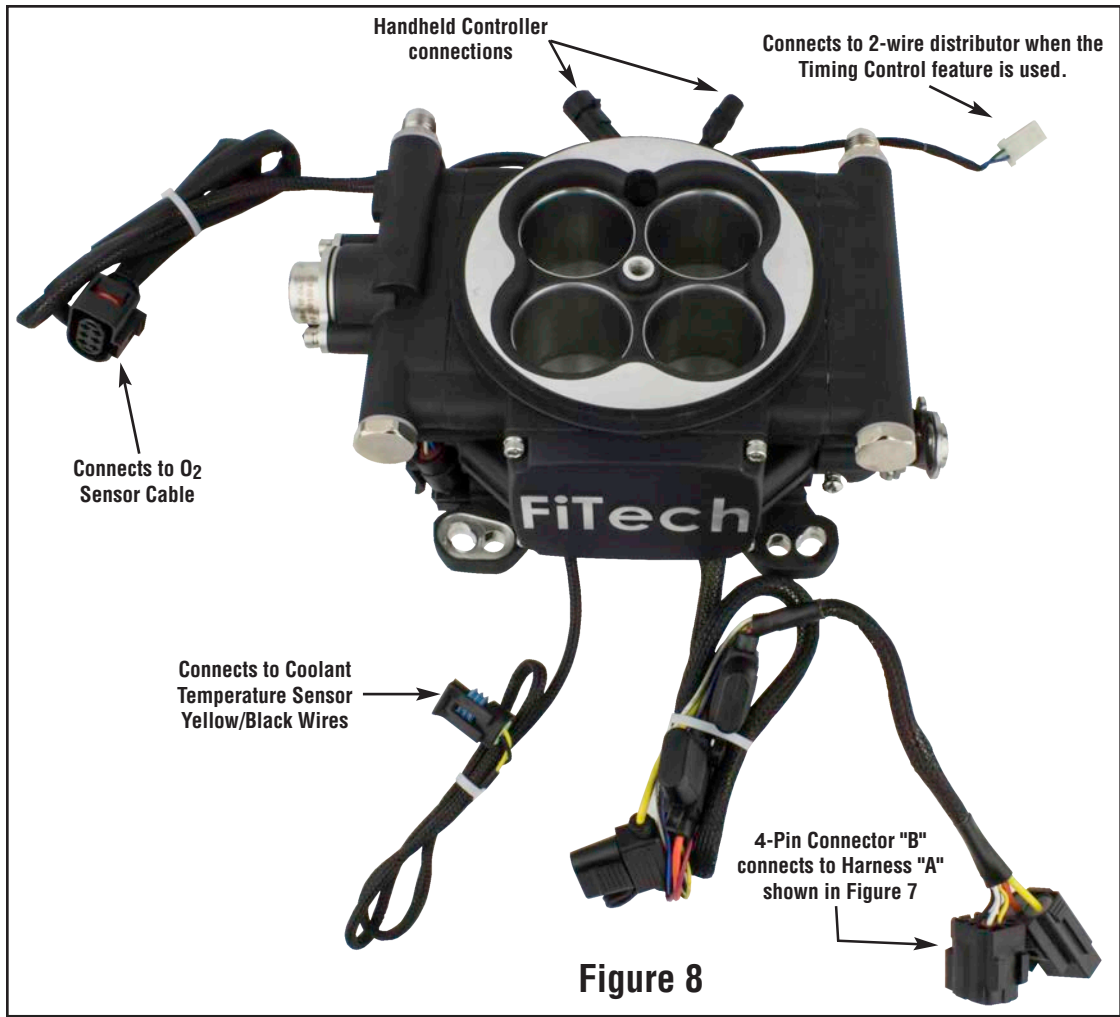

The above photo shows all of the cables that are associated with the FiTech Go EFI System throttle body. The large cable at the bottom left connects to the supplied

Harness "A" which contains the main six wires used in the system. The large coiled cable at top left connects to the supplied Oxygen Sensor cable.

Wiring Chart

The Chart below lists all of the wires in the FiTech Go EFI System. The wires are color coded and the wires that are part of Harness "A" are all marked for where they go. There are six wires in Harness "A." Four of them are required connections and two are optional. One of the op-

tional wires (Black) is required when the Timing Control feature is being used. If Timing Control is not used, then the Blue wire is used in place of the Black wire. More detailed connection information (Figures 9 through 13) is provided on later pages of these instructions.

The Following Wires Are Used In All Systems (4+2 Connector)		
Req./Opt.	Wire Color	Description
Required	Red (Large)	Main power. Connect this wire directly to the positive (+) terminal of the battery. This circuit needs to be live even when the switch is off so that the self learning files are maintained. This is fused with a 25 amp fuse.
Required	Yellow/Black	This wire connects to the Engine Coolant Temperature Sensor
Required only if Timing Control is not used	Blue	This is the tach input wire which triggers the system. It connects to the 12V Negative terminal of the coil. On HEI distributor it connects to the "Tach" terminal on the distributor cap or connects to a tach output on a CDI box.
Required only if Timing Control is used	Black	This is the coil trigger wire. Connect this wire to the points wire on any external ignition CDI box such as an MSD 6A or to negative coil post if not using a CDI box.
Required	Orange (Large)	Fuel Pump circuit. This wire provides 12V to the fuel pump and connects to the positive (+) terminal on the pump. No relay is required.
Required	O ₂ Harness	This cable from ECU connects to the Wide Band Oxygen Sensor harness.
Required	Wiring Harness A	This connects to Connector "B" from ECU. See Figures 7 and 8 (Page 5).
Required	White	On/Off - Connect this wire to a switched 12V circuit. Must be on during both "Key On" and "Cranking." DO NOT connect to the coil terminal when using an external CDI box such as an MSD 6A or any other CD ignition.
Optional Used with Timing Control	Violet (+) Green (-)	This is the input for a magnetic pickup, such as from an MSD distributor or any other magnetic pickup two-wire distributor. This connection is only used in conjunction with the Timing Control feature.
Optional	Yellow	Fan Circuit #1. This wire goes to the ground terminal of the fan relay.
The Following Additional Wires Are Used In Power Adder Systems (4-Pin Connector)		
Req./Opt.	Wire Color	Description
Optional	Red (Thin)	Air Conditioning
Optional	Black	Fan Circuit #2. This wire goes to the ground terminal of the fan relay.
Optional	White	Nitrous "IN" Signal. This should receive 12V positive when Nitrous arming safety switch is activated.
Optional	Tan	Nitrous "OUT" signal. This is the relay ground for nitrous solenoids. Trigger wire cannot ground the Nitrous solenoud directly. Must use relay.

Wiring Diagrams

On the following five pages are various wiring diagrams that address the most common ignition arrangements that will be found. Each diagram will show you the specifics of how to wire your FiTech Go EFI System for that particular ignition setup. Note that the FiTech Go EFI timing control feature cannot be utilized if you have a

"ready-to-run" distributor or an HEI distributor. It will work with most other aftermarket or stock distributors but in every instance the advance mechanism in the distributor must be locked so it cannot function when using timing control. Most aftermarket distributors provide instructions on how to lock the advance mechanism.

Selecting the correct wiring schematic: Review Figures 10 through 14 and select the schematic that suits your particular application. Note that if you elect to use Timing Control you must select a suitable schematic. Figure 10 shows how to connect a ready-to-run distributor without timing control. Figure 11 is for an HEI distributor without timing control. Figure 12 is for a system with an external CDI box without timing control while Figure 13 is a CDI box with timing control. And Figure 14 is with a conventional 2-wire distributor with timing control. One of these configurations will suit your vehicle.

Wiring Connections for FiTech Go EFI System with Ready-to-Run Distributor w/o Timing Control

Timing Control cannot be used with Ready-to-Run Distributor

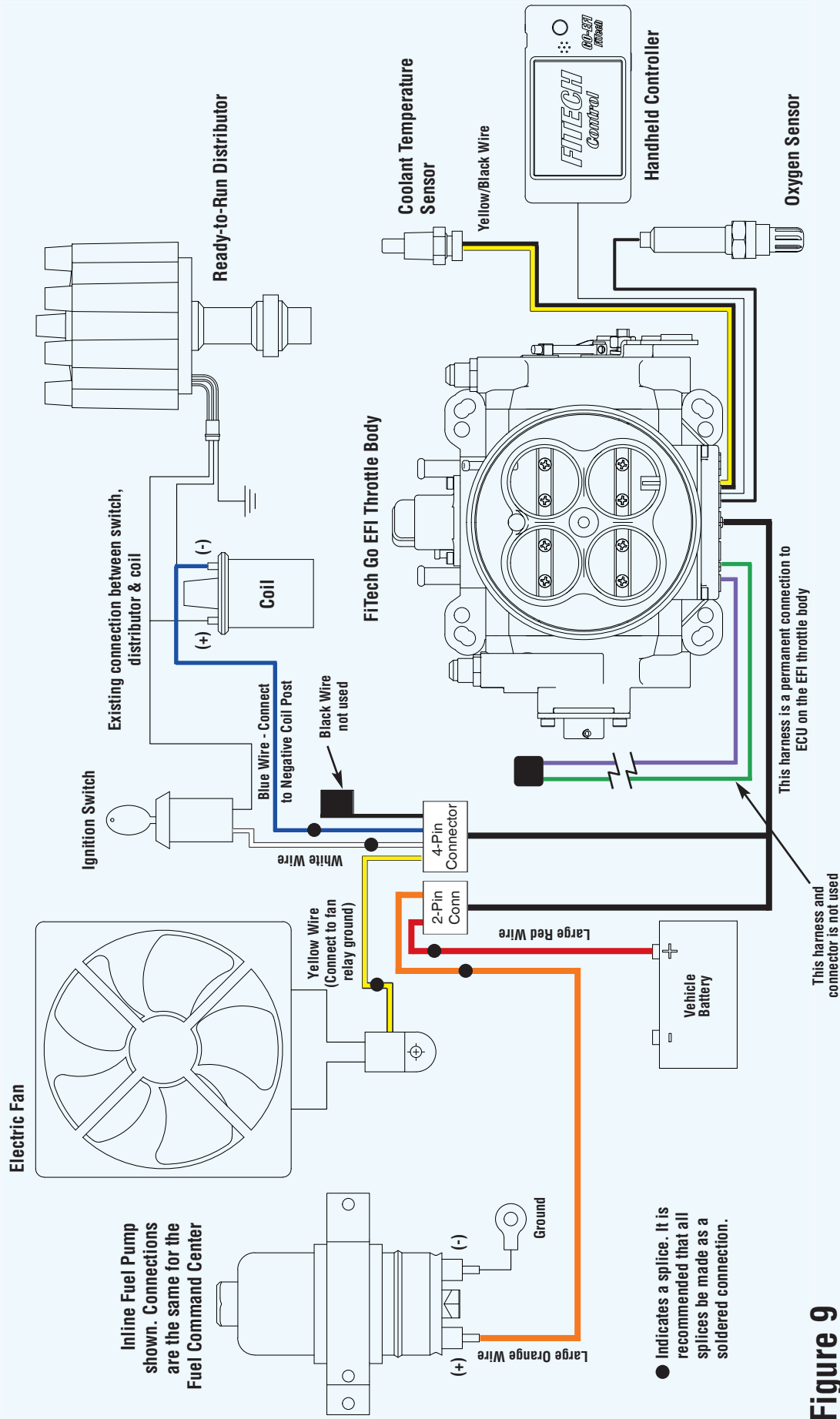

Figure 9

Wiring Connections for FiTech Go EFI System with HEI Distributor w/o Timing Control

Timing Control cannot be used with HEI Distributor

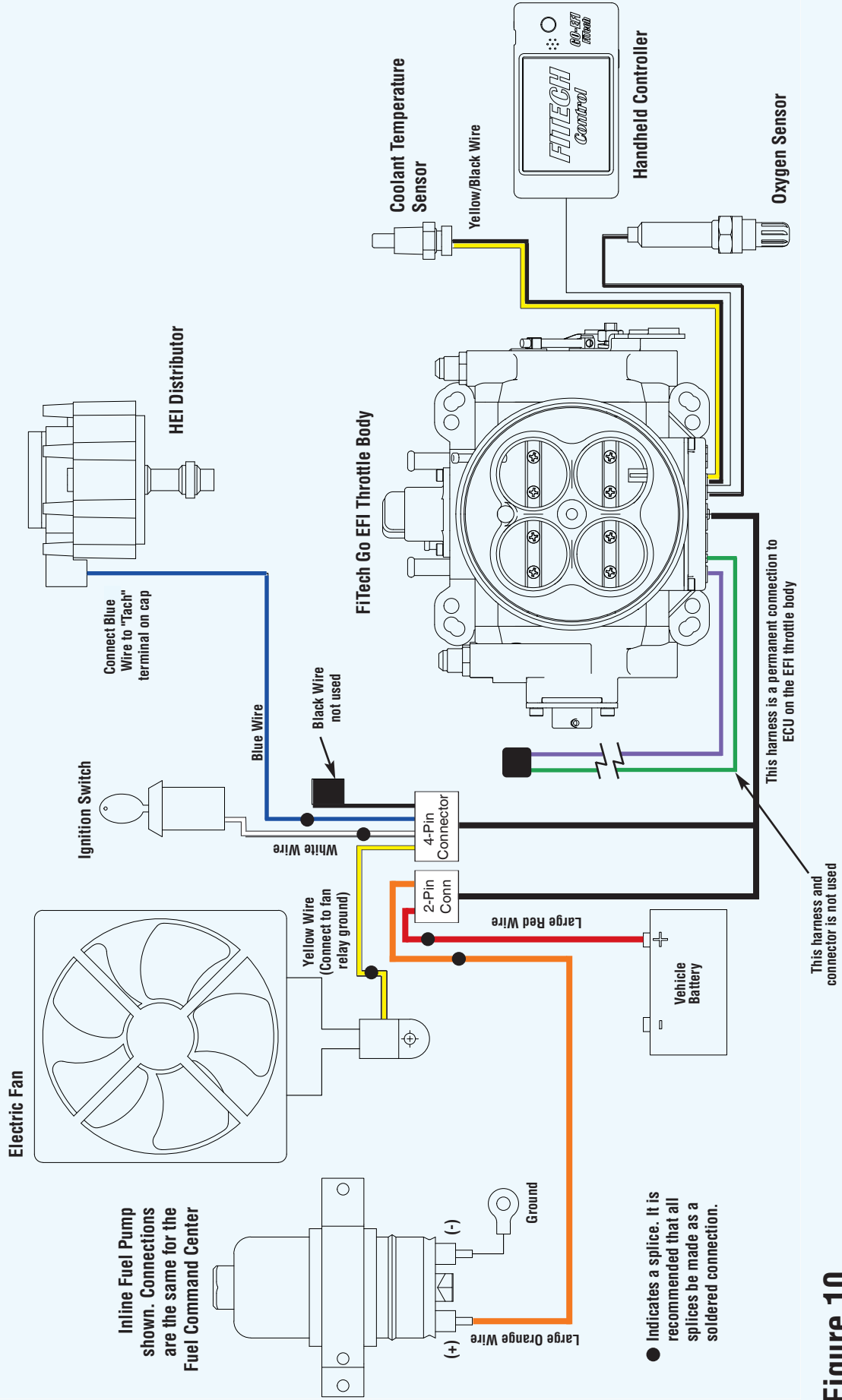
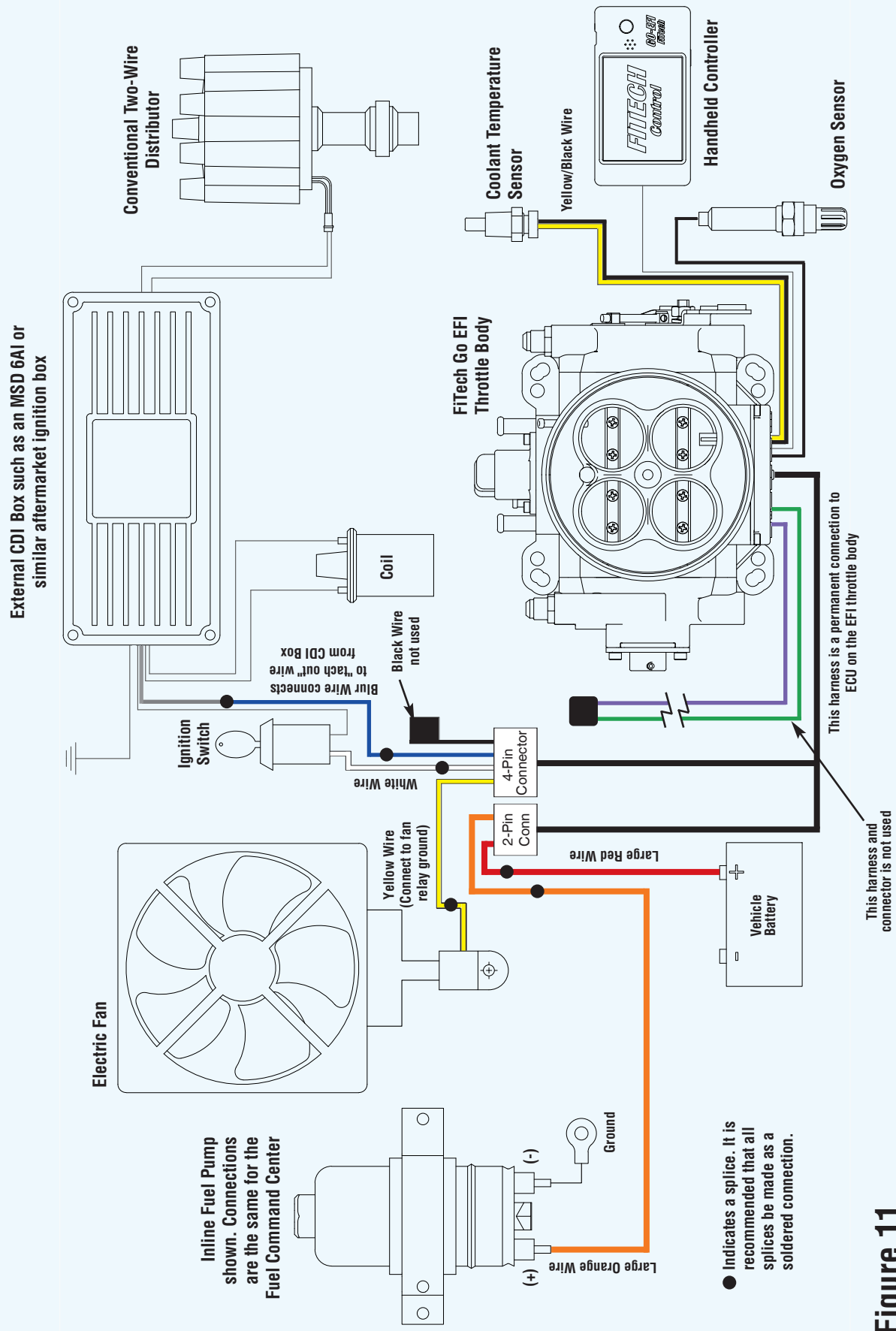

Figure 10

Use this wiring schematic if you are utilizing an HEI distributor without an external CDI box, such as a MSD 6AL or similar aftermarket ignition box. Note that the Fitech EFI Timing Control feature cannot be used with this type of distributor. All other EFI features are compatible.

Wiring Connections for FiTech Go EFI System with External CDI Box w/o Timing Control



● Indicates a splice. It is recommended that all splices be made as a soldered connection.

Figure 11

Use this wiring schematic if you are utilizing a conventional two-wire distributor with an external CDI box, such as a MSD 6AL or similar aftermarket ignition box, and you will not be using the FiTech Timing Control feature. See Figure 11 for this configuration with Timing Control.

Wiring Connections for FiTech Go EFI System with External CDI Box with Timing Control

To utilize FiTech Timing Control, the advance mechanism on the distributor must be locked and inoperative.

Inline Fuel Pump shown. Connections are the same for the Fuel Command Center

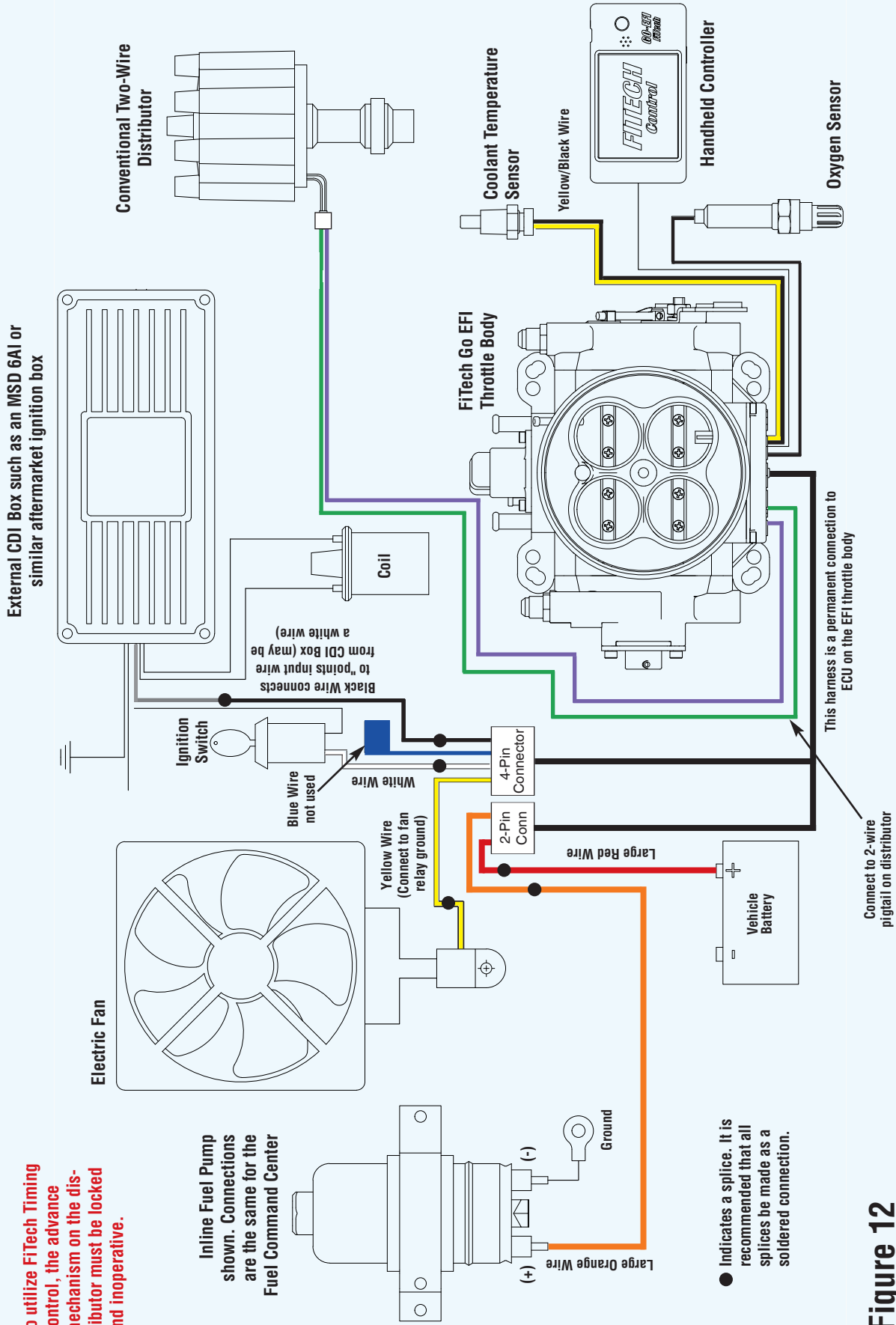

Figure 12

Use this wiring schematic if you are utilizing a conventional two-wire distributor with an external CDI box, such as a MSD 6AL or similar aftermarket ignition box, and you want to use the FiTech Timing Control. Note that your mechanical advance mechanism must be locked to use Timing Control.

Wiring Connections for FiTech Go EFI System with Conventional Distributor w/Timing Control

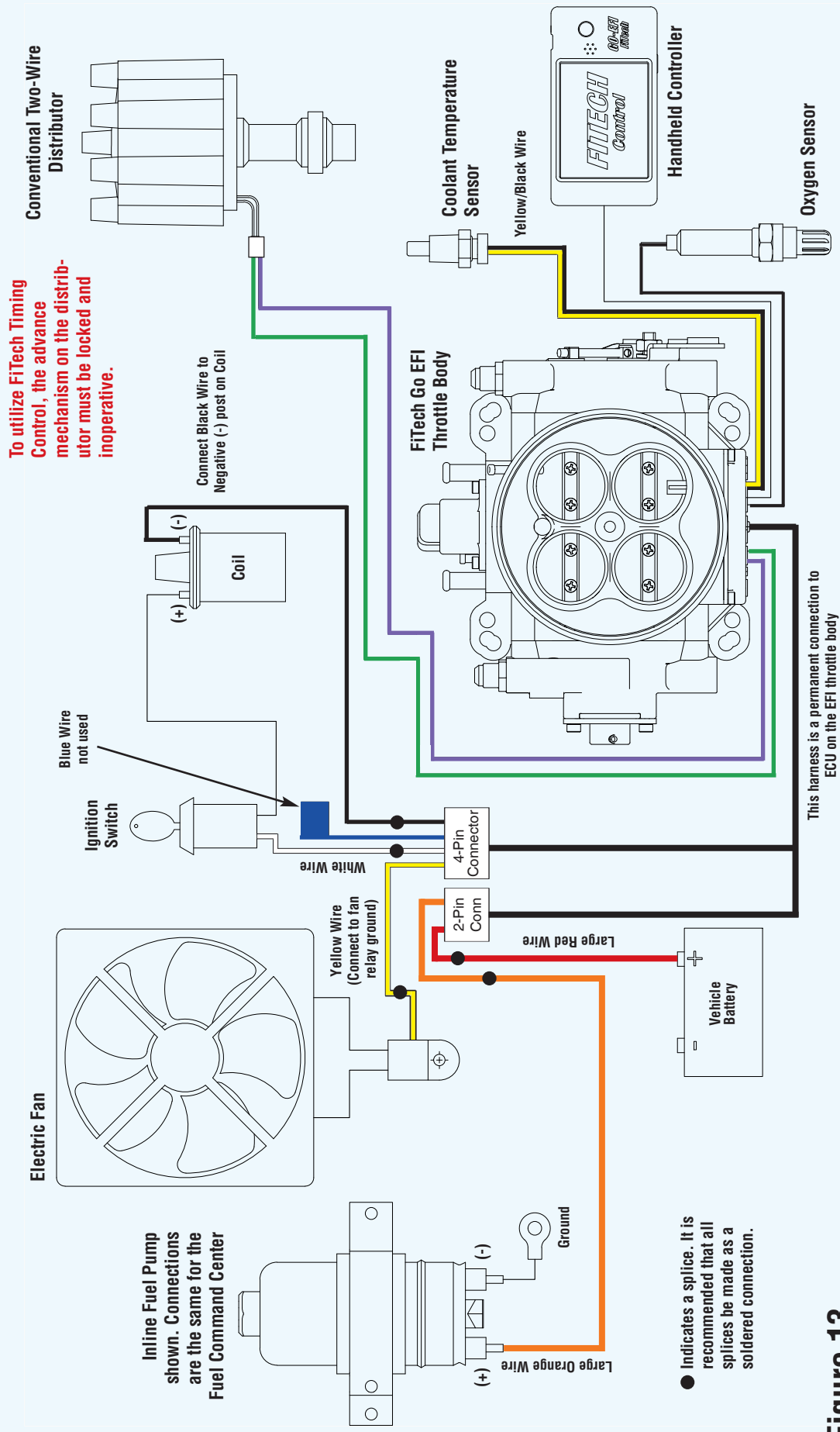

Figure 13

Use this wiring schematic if you are utilizing a conventional two-wire distributor ignition box, and you want to use the FiTech Timing Control. Note that your distributor without an external CDI box, such as a MSD 6AL or similar aftermarket mechanical advance mechanism must be locked to use Timing Control.



INSTALLATION INSTRUCTIONS

Go-Spark CD Ignition - PN 91000

Thank you for choosing FiTech for your high performance ignition needs. The FiTech Go-Spark Ignition is a Capacitive Discharge Ignition (CDI) which produces high voltage sparks from cranking to extreme rpm. The high voltage sparks are the result of advanced digitally controlled technology coupled with an efficient transformer and capacitor. Another benefit of the FiTech CDI is that it produces a series of sparks at lower rpm. This means that several sparks occur over a span of 20° of crankshaft rotation from cranking to about 3,000 rpm.

Installation Information

- When making any electrical connections, always disconnect the negative battery cable.
- The Go-Spark CDI is protected against reverse polarity and voltage spikes.
- After installing the Go-Spark CDI, the ignition timing must be checked and reset if necessary. In some applications, due to the efficient digital circuitry, small timing changes can occur.
- It is recommended to use a coil designed for CDI style ignitions.
- Be sure to use a high quality set of spiral wound spark plug wires. Do NOT use solid core plug wires.
- When checking ignition timing, many digital or dial-back timing lights will not work with the multi-sparks of the Go-Spark CDI.
- The Go-Spark CDI provides a tach output wire (Blue) that delivers a 12-volt square wave signal for tachometers or EFI systems. Most tachs accept this signal however some older tachs an adapter may be required. Contact FiTech Support for info – techmail@fitech.com.
- The Go-Spark CDI is designed for a 12-volt, negative ground electrical system and can also be used with 16-volt systems. It will produce full-output sparks with a supply of 10-20 volts.
- If an alternator is not being used, be sure to use a fully charged battery that can handle a current draw of .9 amps per 1,000 rpm. Be sure to consider other electrical devices as well.
- It is recommended to stick with a good quality spark plug. As for the plug gap, please use the builder or manufacturer's recommendation. As a rule of thumb, the gap can be opened .005".
- If welding on the vehicle, it is recommended to disconnect the main harness of the ignition.

Mounting: The FiTech Go-Spark CDI is designed to be mounted in the engine compartment, but should be away from excessive heat sources and where water may reach. Before mounting, confirm that the harness reaches all of the wiring connections. Once a location is determined, mark the mounting hole locations and drill the holes with a 3/16" bit. Sheet metal mounting screws are supplied for a secure mount.



WARNING: Cancer and Reproductive Harm www.P65Warnings.ca.gov

LED: The LED on the Go-Spark CDI will glow solid with the key on to confirm 12+ volts and a good ground.

Cylinder Select: The Go-Spark CDI is set for operation on V8 engines though it can be used on 4- or 6-cylinder engines as well. For use on an even-fire 6-cylinder, cut the Orange wire loop. For use on a 4-cylinder engine, cut the Orange and the Gray wire loop.

Wiring: The Go-Spark CDI is supplied with a complete wiring harness designed to work with most applications. If a wire must be lengthened, always use a wire that is one size larger along with a quality terminal and crimp. Review the chart below for the function and connection of each wire followed by the wiring schematic for your application. If you require a specific schematic, reach out to techmail@fitechefi.com for more information.

Grounds: The ground connection should be routed directly to the battery negative post or engine block. Be sure to have a ground wire between the engine and chassis. All grounds should be connected to a bare metal surface that is free of paint, coatings or grease.

Factory Ballast Resistor: If a ballast resistor or wiring is used on the coil wiring, bypass it in both the ignition and/or coil connection.

Wire	Function	Connection
Heavy Red	Main Positive	Connect directly to battery positive or main junction stud. Do not connect to alternator
Heavy Black	Main Negative	Connect to battery negative or the engine block
Red	On/Off	Connect to a switched 12 volt source. This is the on/off wire for the ignition
Brown	Coil positive	This is the ONLY wire connected to the coil positive terminal
Black	Coil negative	This is the ONLY wire connected to the coil negative terminal
Trigger Wires		Use the White wire or 2-pin magnetic pickup connector
White	Trigger Signal	Connect to the original coil negative wire of breaker points or amplifier output
Violet	Mag Pickup +	Two pin connector for use with Magnetic Pickup distributors, positive
Green	Mag Negative -	Two pin connector for use with Magnetic Pickup distributors, negative
Orange or Gray	Cylinder Select	V8 engines do not modify. 6-cylinders, cut one loop. 4-cylinders, cut both loops
Blue	Tach Output	Connects to a tachometer, rpm activated device or EFI system trigger input

Wiring Diagrams: Following are several wiring schematics. You may find more at www.fitechefi.com or please contact our tech team at techmail@fitechefi.com

Installing to a Magnetic Pickup (2-wire) Distributor

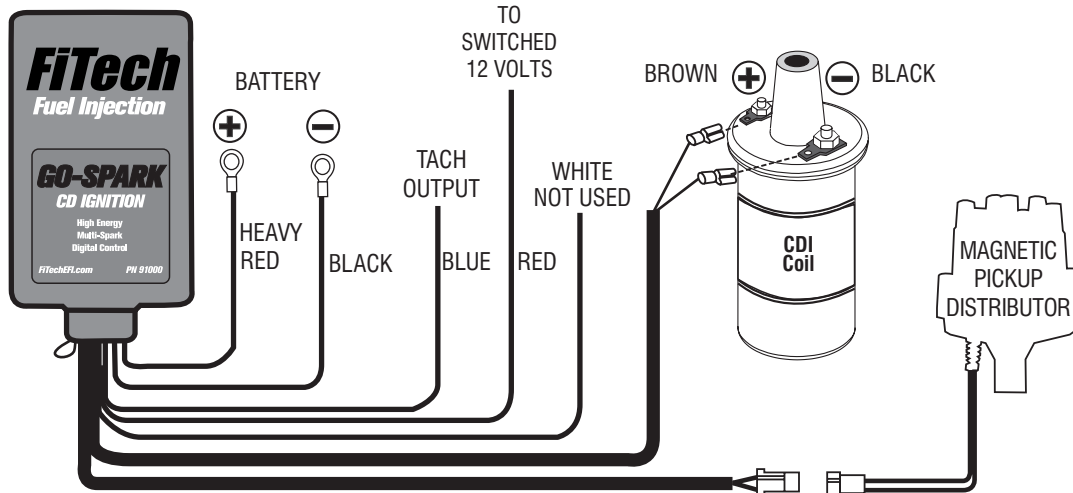

Installation to a Magnetic Pickup Distributor and FiTech Throttle Body EFI System

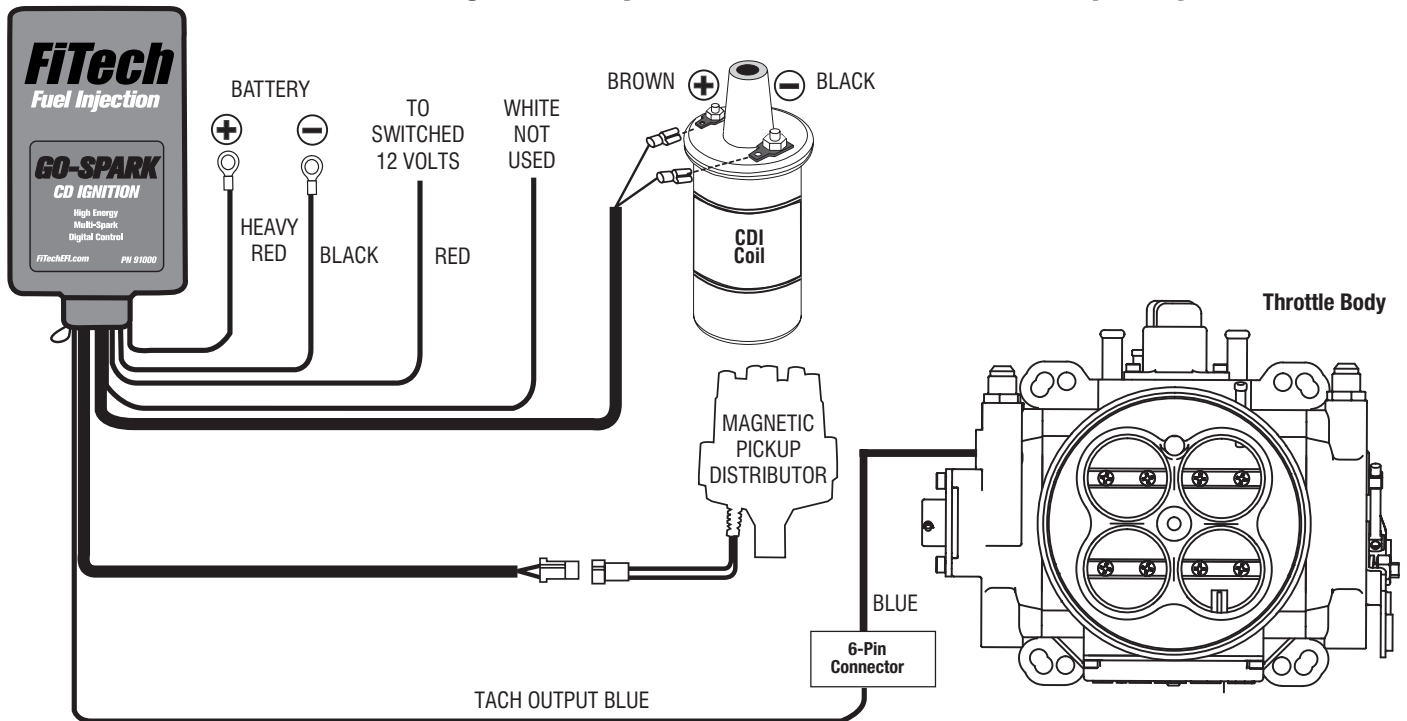

Installation to GM HEI Distributor (4-pin Module)

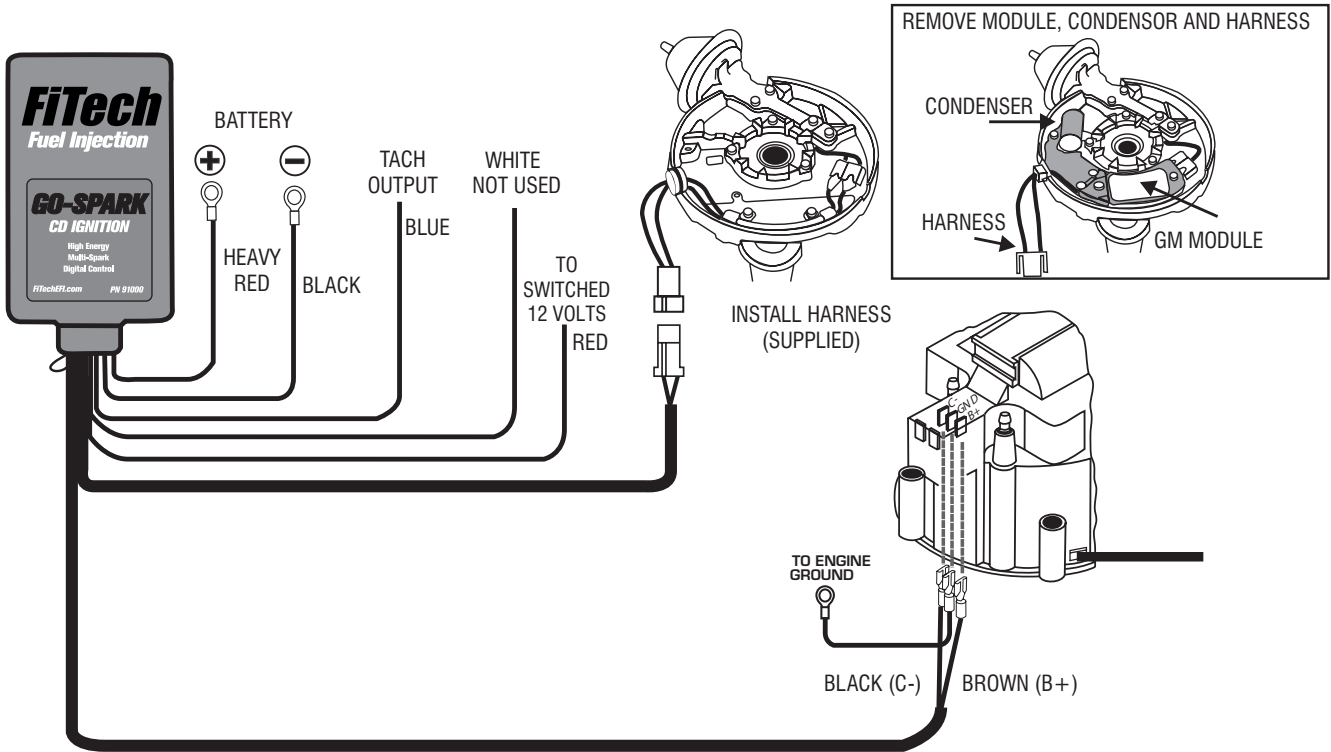

Installation to GM HEI Distributor 7-pin Module

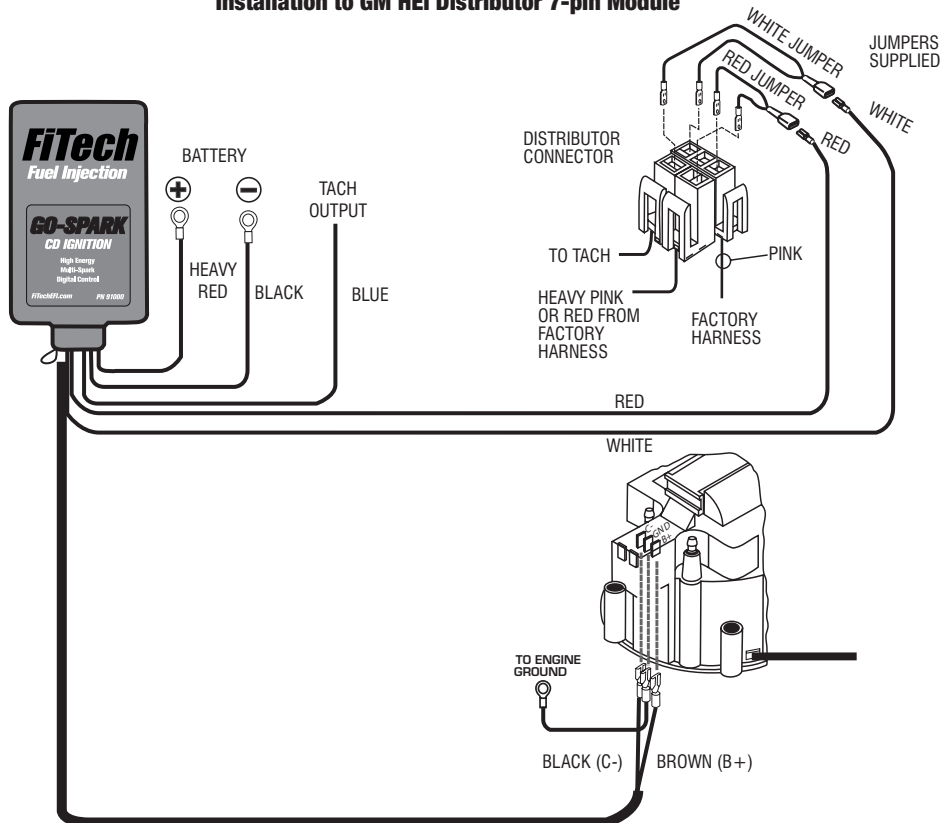

Installation to Ford TFI

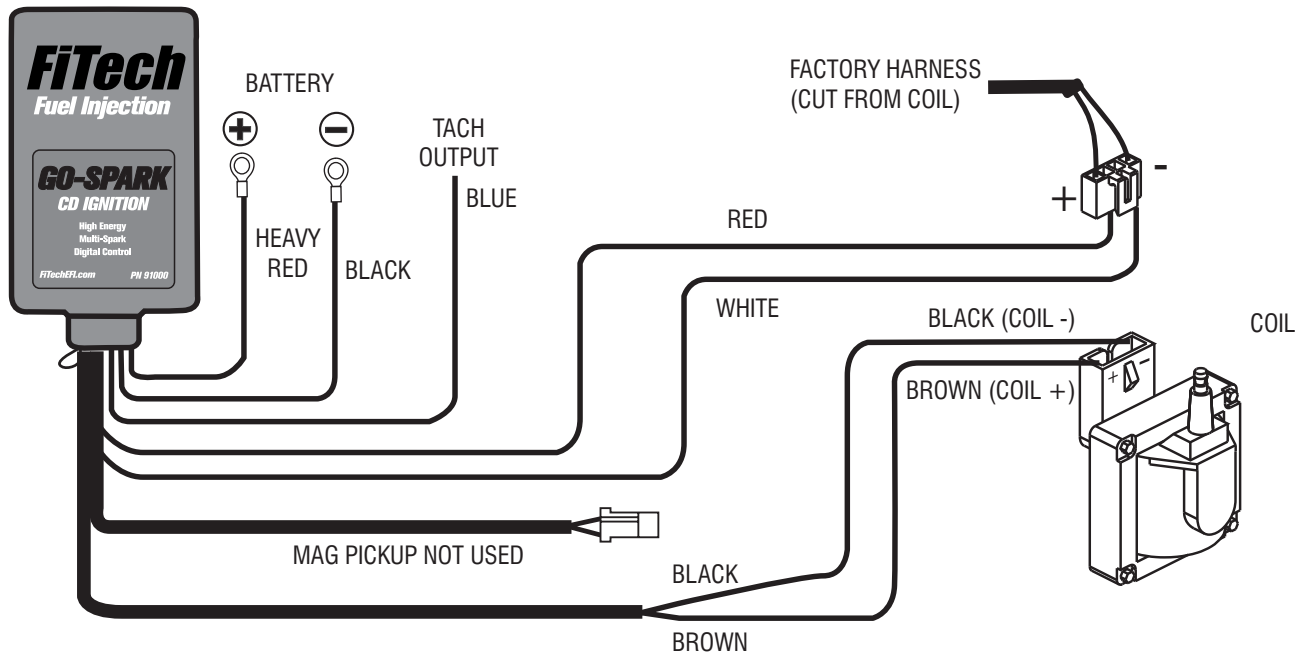

TROUBLESHOOTING

Intermittent Issues

If experiencing intermittent issues or engine misfires the culprit can generally be tracked to a faulty spark plug wire, burned boot, worn distributor cap, wiring connection or ground. Before testing the ignition box, please review the following:

- Is the battery fully charged and the alternator is properly charging? The Go Spark CDI requires a supply of over 10 volts or the output may suffer
- Is the engine running lean? Inspect the spark plugs and fuel system
- Inspect the wiring connecting to the coil. The only two wires should be the brown and orange wires of the Go Spark CDI connected to the negative and positive terminals respectively. Also ensure that the plug wire to the distributor is connected properly and in good shape. (Remember, this wire does eight times the work as the other cylinders!)
- Inspect the plug wires, terminals and boots. Always use a quality set of suppression spark plug wires – never use solid core wires

Tachometer Issues

If you're factory or aftermarket tachometer does not work properly after installing the Go Spark CDI, please contact customer support at: techmail@fitechefi.com or call 951-340-2624. It is likely an easy solution and due to the 12-volt square wave output signal on the blue tach wire of the ignition. This is a common signal today, but some older factory tachometers may have trouble.

Engine Run-On

If your engine continues to run after installing the Go Spark CDI, it is likely due to a low voltage feedback signal from the original charge lamp indicator when still equipped with the factory plug-in style alternator. There are several easy fixes depending on the application.

A diode, which allows voltage to travel only one direction, is supplied in the parts bag. The diode must be installed on the wire going to the charge indicator and needs to be in the right direction.

Early Ford: Install the diode in-line on the wire connecting to terminal 1 of the external voltage regulator

Early GM: Install the diode in-line on the wire connecting to terminal 4 of the external voltage regulator.

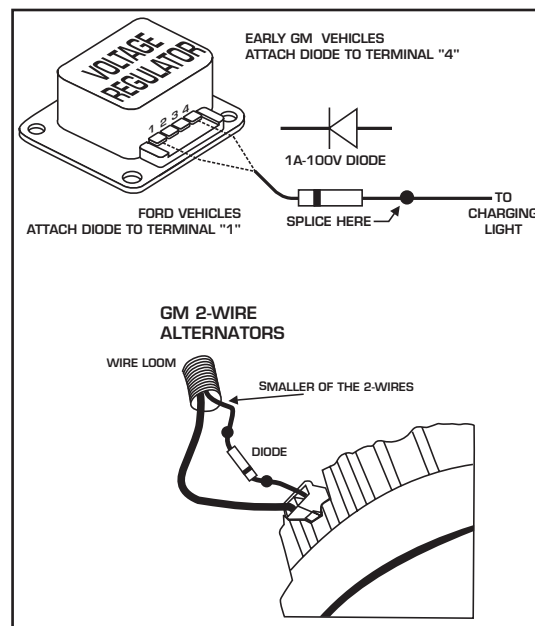

Diode Placement

1973-1983 GM Alternators: These alternators use an internal regulator. Install the diode on the smaller of the two wires connected to the alternators. In most cases this wire is Brown.

For other applications, please contact our support team at tech@fitechefi.com or call 951-340-2624.

Test for Spark

The Go Spark CDI can easily be tested to confirm that it is producing a spark. Follow the procedure below to 'false trigger' the ignition to verify it is firing.

1. With the ignition in the off position, remove the coil wire from the distributor cap.
2. Place the coil wire terminal about ½" from ground (away from any fuel sources).
3. If triggering with the white wire of the CDI, disconnect that wire from the distributor or FiTech EFI system. If triggering with the 2-pin mag pickup harness, disconnect it from the distributor
4. Turn the ignition to the on position – do not crank the engine
5. For a **white wire trigger**, tap the white wire to ground several times. A spark should jump from the coil wire to ground. This means the ignition is working.

For a the mag pickup harness, jump the two wires together using a paperclip or jumper wire. Each time the connection is broken, a spark should jump to ground. This means the ignition is working.

If there was no spark:

- Install another coil and repeat the test
- Confirm there are 12 volts on the small red wire of the CDI when the ignition is on. Also make sure there is 12 volts on the red wire during cranking
- Inspect the rest of the wiring and grounds to ensure proper connections
- If there is still no spark, the ignition is likely in need of repair. Contact our tech support team to review the warranty or repair of your ignition.



WARNING: This product can expose you to chemicals including Chromium, Lead, Lead Compounds, Nickel (Metallic), Nickel Compounds, Diisonyl and Di(2-ethylhexyl) Phthalates (DEHP)(DINP) which are known to the State of California to cause cancer or birth defects or other reproductive harm. **For more information, visit www.P65warnings.ca.gov.**