



Equipped with AEM® Dryflow™ Filter
No Oil Required!

INSTALLATION INSTRUCTIONS

PART NUMBER: 21-547

2003-2006 NISSAN 350Z V6-3.5L

C.A.R.B. E.O. # D-670-2

INTAKE SYSTEMS FOR VEHICLES
LISTED ARE 50 STATE LEGAL. SEE
AEMINTAKES.COM FOR CARB STATUS ON
EACH PART FOR A SPECIFIC VEHICLE.

PARTS LIST

Description	Qty.	Part Number
Air Filter Assy. 3.00 X 5" Dry Ele.	1	21-203DK
Upper Pipe	1	2-527
Inlet Pipe	1	2-544
Adaptor, MAF	1	2-641TK
Hose, Silicone 3.00x3" Blk.	2	5-300
Hose, Adapter 3.25/3.00 X 2.25"	1	5-323
Mount, Rubber 1" X 6mm	1	1228599
Spacer, .625 OD X .295 ID X .1	1	2-125
Bracket, 21-547	1	7-7388
Bolt, Hex M6 X 1.0 X 16mm	4	1-2030
Bolt, Hex M8-1.25 X 30 Full	1	1-2080
Washer, M6 X 12mm OD Zinc	4	1-3018
Washer, 6mm Soft Mount	1	08160
Nut, M6 Hex Serrated	1	444.460.04
Nut, M8 Hex Serrated	1	444.460.08
1/2" Bnd. Hose Clamp, 2.56"-3.50"	5	9448
1/2" Bnd. Hose Clamp, 2.90"-3.75"	2	9452
Plug, 7/8"	1	8-132

Read and understand these instructions **BEFORE** attempting to install this product. Failure to follow installation instructions and not using the provided hardware may damage the intake tube, throttle body and engine.

The AEM® intake system is a performance product that can be used safely during mild weather conditions. During harsh and inclement weather conditions, you must return your vehicle to stock OEM air box and intake tract configuration. Failure to follow these instructions will void your warranty.

1. Preparing Vehicle

- a. Make sure vehicle is parked on level surface.
- b. Set parking brake.
- c. If engine has run in the past two hours, let it cool down.
- d. Disconnect negative battery terminal.
- e. Raise the front of the vehicle with a jack. Refer to your owner's manual for proper jack and jack stand placement to properly support vehicle. Support your vehicle using properly rated jack stands before wheel removal or while working under the vehicle.

NEVER WORK UNDER A VEHICLE WITHOUT USING JACK STANDS.

- i. Remove driver side wheel.
- f. Do not discard stock components after removal of the factory system.

2. Removal of stock system

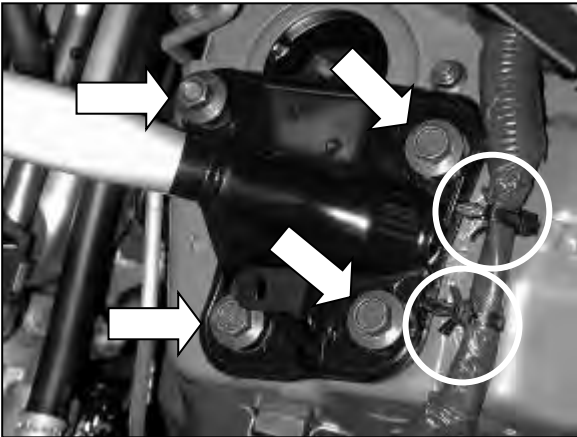

a. Remove the bolts holding the strut tower bar in place from both sides. Unclip the electrical wiring loom connections and remove the bar from the engine bay.

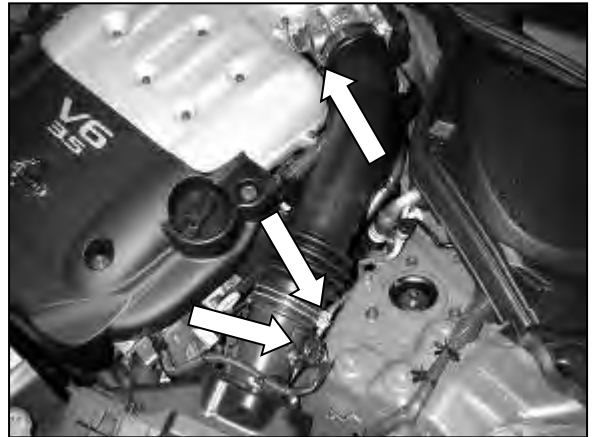

b. Loosen the hose clamps shown in the picture. Unplug the mass air flow (MAF) sensor and detach the MAF wiring harness from the sensor.

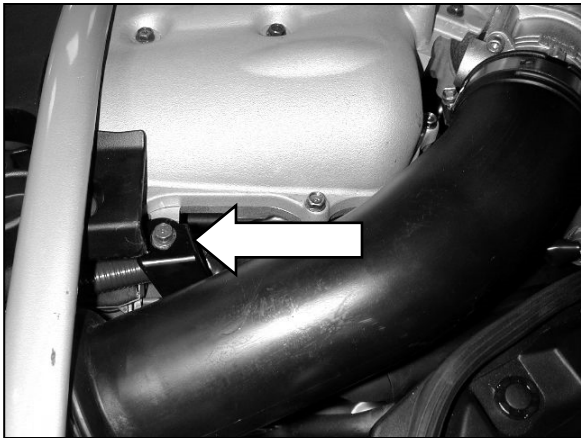

c. Remove the bolt securing the inlet pipe to the intake manifold.

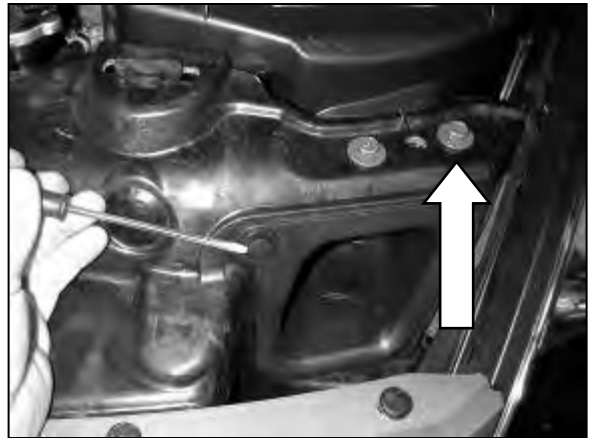

d. Pop out and remove the plastic fastener on the front air duct. Unsnap the duct and slide it forward. Remove the specified bolt as shown.

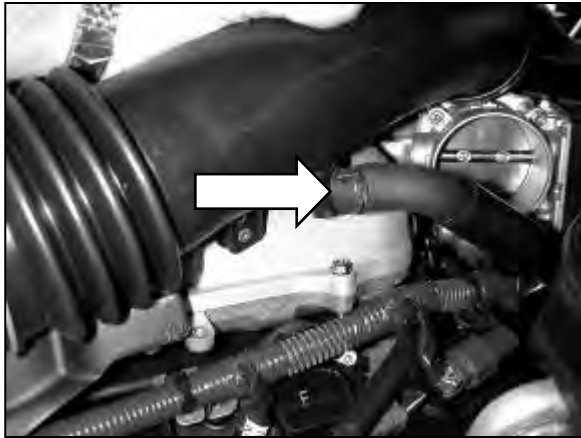

e. From the underside of the intake tube, detach the breather hose then remove the intake tube from the engine bay.



f. Remove the bolt holding the air filter housing assembly in place.



g. Gently pull directly upward on the air filter housing assembly until it unsnaps from its mounts. Remove it from the engine bay.

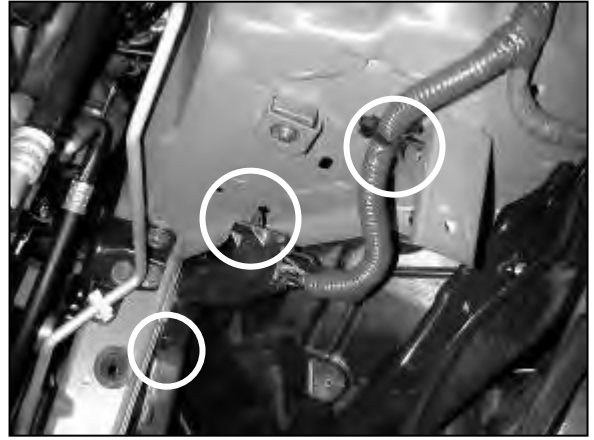

h. Unsnap the wiring loom fasteners from the inner fender.

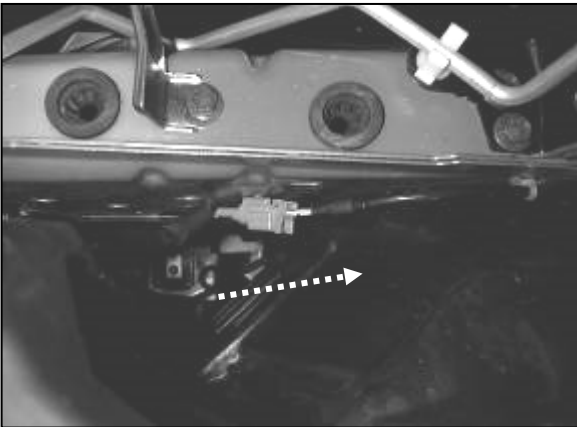

i. Looking where the factory air filter housing was, pull the wheel speed sensor plug shown in the picture from its mount.
NOTE: DO NOT unplug the sensor.

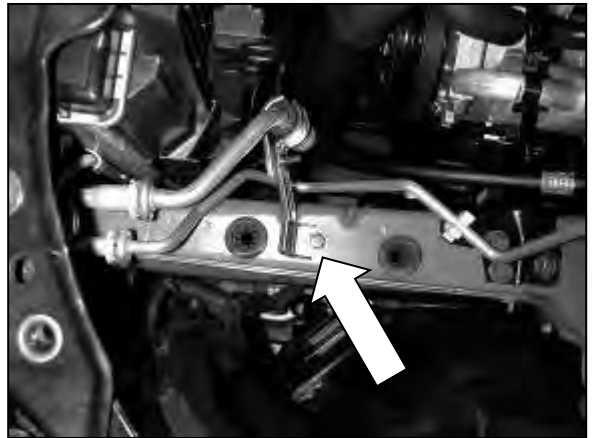

j. Remove the A/C line bracket bolt shown in the picture.

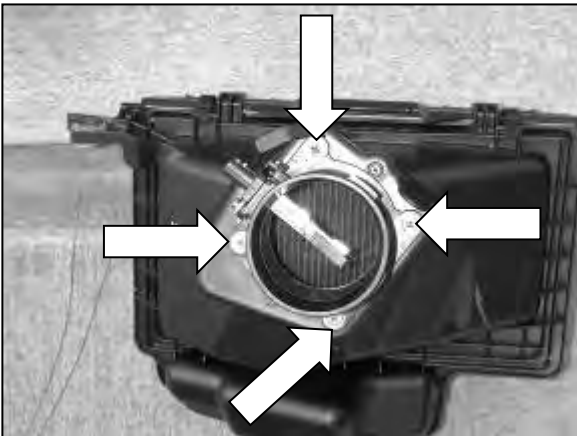

k. Remove the MAF sensor from the air filter assembly by removing the four mounting bolts.



l. From the underside of the car, remove the bolts shown in the picture.

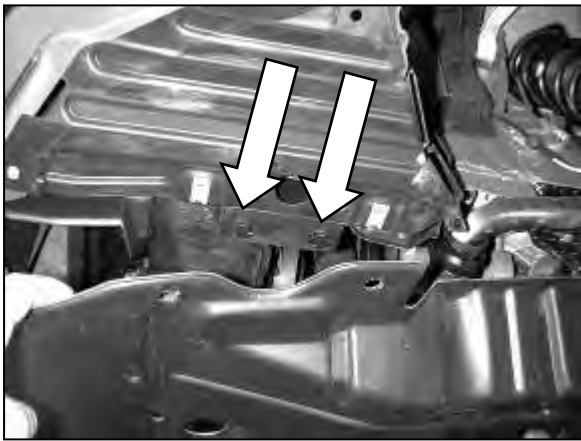

m. Pull down on the splash guard to reveal two plastic fasteners. Remove these fasteners.

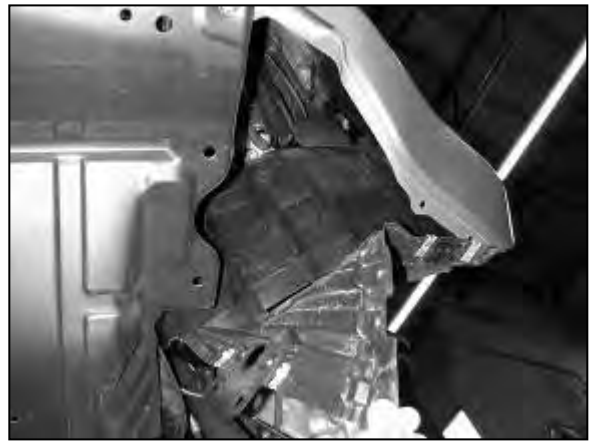

n. It is now possible to gain access to the area behind the front bumper. This is where the air filter will be located.

3. Installation of AEM® intake system.

a. When installing the intake system, do not completely tighten the hose clamps or mounting hardware until instructed to do so.

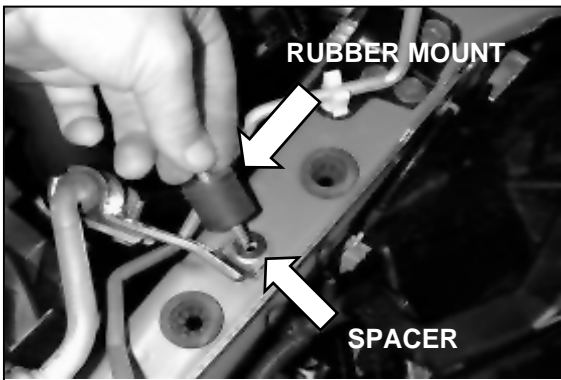

b. Install the rubber mount into the hole that was exposed when the A/C line bracket was removed to step 2j. Use the included spacer underneath the rubber mount to space it upward to clear the bracket. Tighten by hand.

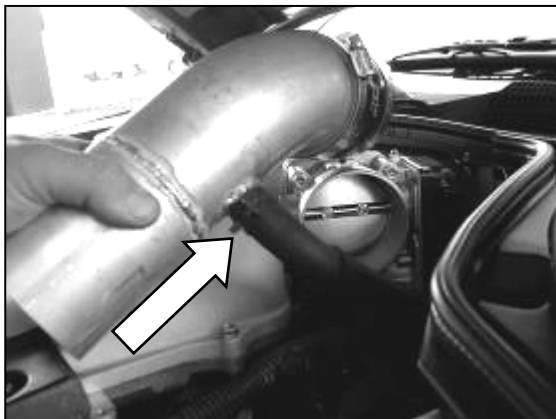

c. Attach the breather hose to the fitting to the AEM® upper intake pipe (the shorter one in the kit). Put the 3 ¼" to 3.0" silicone reducer on the end of the pipe closest to the bend. Place the 3 ¼" side of the silicone coupler over the throttle body.



d. Using the four bolts and washers included in the kit, attach the AEM® MAF adaptor to the Nissan MAF sensor.



e. Place the 3" silicone coupler around the MAF sensor, not the AEM® MAF adaptor. Connect the assembly to the upper intake pipe. Use the #52 hose clamp around the throttle body and the #48 hose clamps for the 3" diameter tubing. Do not tighten the hose clamps.

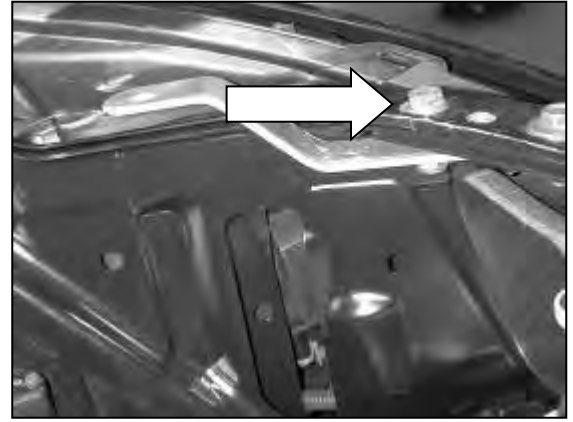

f. Install the 8mm bolt and washer included in the kit into the bolt hole exposed in step 2d. Attach the AEM® wiring harness bracket to the bolt on the underside and secure it in place with the included 8mm nylok nut.

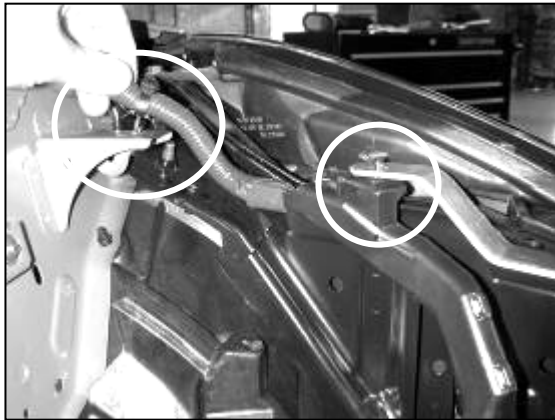

g. Snap the factory wiring harness into the bracket as shown. Insert the other plastic wiring loom holder into the hole from the bolt removed in step 2f of the previous section.



h. Inside the cavity behind the bumper, unsnap the wiring loom from the body.



i. Tuck the wiring up and out of the way.



j. Install the air filter onto the end of the lower intake pipe closest to the 7/8" hole. Install the recessed plastic plug in the hole in the intake pipe.



k. Install the 3" coupler and two #48 hose clamps on the end of the MAF adaptor. Insert the upper end of the lower intake pipe into the coupler.



l. Line up the tab on the intake pipe with the rubber mount. Run the wheel speed sensor wire underneath intake pipe support tab. Make sure the plug and wire are not in a place where they will be pinched or damaged. Install the nut and washer according to the diagram below.

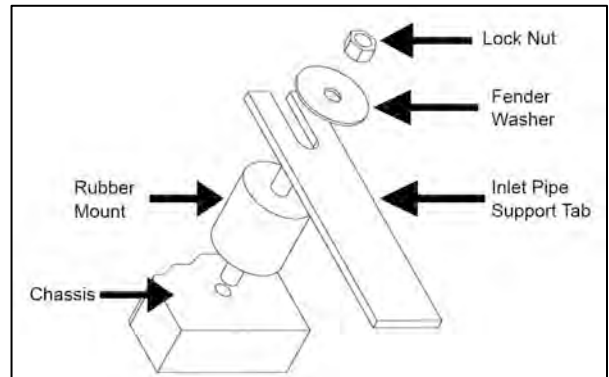

Proper installation of rubber mount assembly.



m. Position the intake pipe and air filter for the best fitment. Ensure that the intake system does not contact any part of the vehicle or any other components. **Ensure the intake pipe does not come into contact with any of the adjacent A/C hard-lines. Contact may result in failure of the A/C system and costly repairs.** After the intake system has been positioned correctly, tighten all hose clamps and the mounting tab hardware. Plug in the MAF sensor and re-install the strut-tower bar.
NOTE: If an AEM® air bypass valve (sold separately) is installed, install it in the section of the intake pipe circled in the image.

4. Reassemble Vehicle

- a. **Fender liner and splashguard:** Install the fender liner, lower splash guard and any hardware that was removed in steps 2l through 2m.

NOTE: Failure to install the fender liner will result in diminished performance and increase the potential for engine damage due to water ingestion in rainy conditions.

- b. Position the inlet pipes for the best fitment. Be sure that the pipes or any other components do not contact any part of the vehicle. Tighten the rubber mount, all bolts, and hose clamps.
- c. Check for proper hood clearance. Re-adjust pipes if necessary and re-tighten them.
- d. Inspect the engine bay for any loose tools and check that all fasteners that were moved or removed are properly tightened.
- e. Reconnect negative battery terminals and start engine. Let the vehicle idle for 3 minutes. Perform a final inspection before driving the vehicle.

5. CARB Sticker Placement

- a. The C.A.R.B. exemption sticker, (attached), must be visible under the hood so that an emissions inspector can see it when the vehicle is required to be tested for emissions. California requires testing every two years, other states may vary.

6. Service and Maintenance

- a. It is recommended that you service your AEM® Dryflow™ filter every 20,000 miles for optimum performance. Use AEM Dryflow cleaning kit part # 21-110.
- b. Use aluminum polish to clean your polished AEM® intake tube.
- c. Use window cleaner to clean your powder coated AEM® intake tube. **(NOTE: DO NOT USE aluminum polish on powder coated AEM intake tubes)**

For technical inquiries
e-mail us at
sales@aemintakes.com
or
call us at
800.992.3000

AEM Air Intake System Warranty Policy

AEM® warrants that its intake systems will last for the life of your vehicle. AEM will not honor this warranty due to mechanical damage (i.e. improper installation or fitment), damage from misuse, accidents or flying debris. AEM will not warrant its powder coating if the finish has been cleaned with a hydrocarbon-based solvent. The powder coating should only be cleaned with a mild soap and water solution. Proof of purchase of both the vehicle and AEM intake system is required for redemption of a warranty claim.

This warranty is limited to the repair or replacement of the AEM part. In no event shall this warranty exceed the original purchase price of the AEM part nor shall AEM be responsible for special, incidental or consequential damages or cost incurred due to the failure of this product. Warranty claims to AEM must be transportation prepaid and accompanied with dated proof of purchase. This warranty applies only to the original purchaser of product and is nontransferable. Improper use or installation, use for racing, accident, abuse, unauthorized repairs or alterations voids this warranty. AEM disclaims any liability for consequential damages due to breach of any written or implied warranty on all products manufactured by AEM. Warranty returns will only be accepted by AEM when accompanied by a valid Return Merchandise Authorization (RMA) number. Credit for defective products will be issued pending inspection. Product must be received by AEM within 30 days of the date RMA is issued.

If you have a warranty issue, please call (800) 992-3000 and our customer service department will assist you. A proof of purchase is required for all AEM warranty claims.

**INTAKE SYSTEMS FOR VEHICLES
LISTED ARE 50 STATE LEGAL. SEE
AEMINTAKES.COM FOR CARB STATUS ON
EACH PART FOR A SPECIFIC VEHICLE.**