



INTAKE SYSTEMS FOR VEHICLES LISTED ARE 50 STATE LEGAL. SEE KNFILTERS.COM FOR CARB STATUS ON EACH PART FOR A SPECIFIC VEHICLE.

INSTALLATION INSTRUCTIONS

57-1142
CAN-AM
2017-19 Maverick X3
900cc

TOOLS NEEDED:

- Flat blade screw driver
- 4mm allen
- 3mm allen

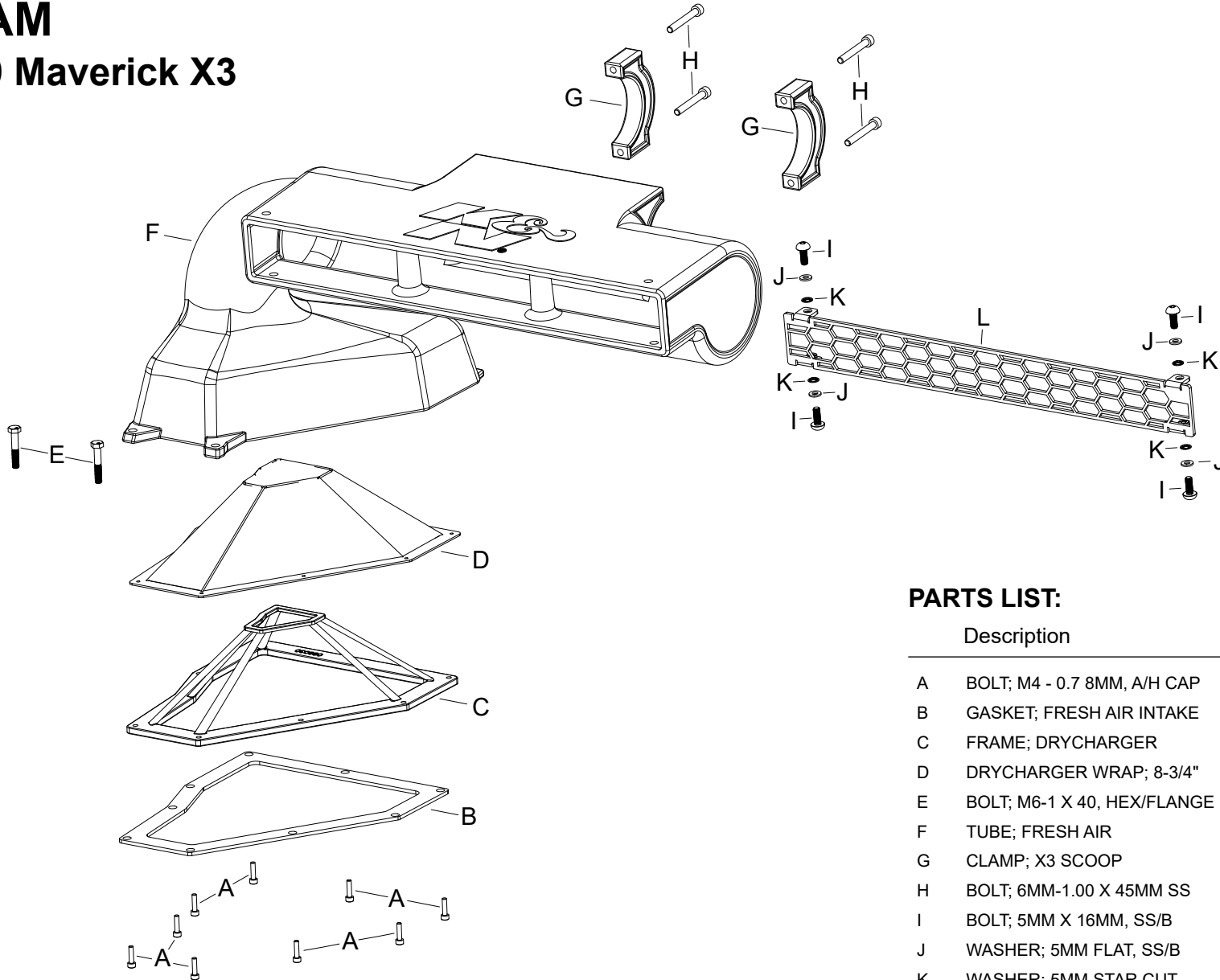

PARTS LIST:

Description	Qty.	Part #
A BOLT; M4 - 0.7 8MM, A/H CAP	9	07733
B GASKET; FRESH AIR INTAKE	1	09774
C FRAME; DRYCHARGER	1	088030
D DRYCHARGER WRAP; 8-3/4"	1	088030DK
E BOLT; M6-1 X 40, HEX/FLANGE	2	1-2075
F TUBE; FRESH AIR	1	087379
G CLAMP; X3 SCOOP	2	088031
H BOLT; 6MM-1.00 X 45MM SS	4	08374
I BOLT; 5MM X 16MM, SS/B	4	22257
J WASHER; 5MM FLAT, SS/B	4	08344
K WASHER; 5MM STAR CUT	4	07724
L INLET MESH; MILD STL	1	073281

If you need any assistance please call 1-800-858-3333 to speak with a representative in our Customer Service Center before returning the product.

NOTE: FAILURE TO FOLLOW INSTALLATION INSTRUCTIONS AND NOT USING THE PROVIDED HARDWARE MAY DAMAGE THE INTAKE TUBE, THROTTLE BODY AND ENGINE.

TO START:

1. Turn off the ignition and disconnect the negative battery cable.
NOTE: Disconnecting the negative battery cable erases pre-programmed electronic memories. Write down all memory settings before disconnecting the negative battery cable. Some radios will require an anti-theft code to be entered after the battery is reconnected. The anti-theft code is typically supplied with your owner's manual. In the event your vehicles anti-theft code cannot be recovered, contact an authorized dealership to obtain your vehicles anti-theft code.



2. Remove the factory intake dust cover by pulling upwards to dislodge it from the mounting grommets.



3. Release the locking clip and remove the factory dust filter.
NOTE: K&N Engineering, Inc., recommends that customers do not discard factory air intake.



4. If intake kit 57-1141 is not previously installed, remove the factory bellows from the vehicle and trim it where indicated and then reinstall the bellows.



5. Remove the two bolts shown.
NOTE: The coupler hose shown is used with K&N® intake kit 57-1141.



6. Install the K&N® dry charger over the dry charger cage as shown.



7. Install the dry charger assembly into the K&N® fresh air intake system and secure with the provided hardware.



8. Install the provided gasket onto the lower portion of the factory fresh air housing and then install the K&N® fresh air system and secure with the hardware provided.



9. Install the inlet mesh into the K&N® fresh air intake and secure with the provided hardware.



10. Install the K&N® fresh air system and secure with the provided hardware.



11. Secure the K&N® fresh air system to the chassis bar with the provided clamps and hardware.



12. Reconnect the vehicle's negative battery cable. Double check to make sure everything is tight and properly positioned before starting the vehicle.

12. The C.A.R.B. exemption sticker, (attached), must be visible under the hood so that an emissions inspector can see it when the vehicle is required to be tested for emissions. California requires testing every two years, other states may vary.

13. It will be necessary for all K&N® high flow intake systems to be checked periodically for realignment, clearance and tightening of all connections. Failure to follow the above instructions or proper maintenance may void warranty.

ROAD TESTING:

1. Start the engine with the transmission in neutral or park, and the parking brake engaged. Listen for air leaks or odd noises. For air leaks secure hoses and connections. For odd noises, find cause and repair before proceeding. This kit will function identically to the factory system except for being louder and much more responsive.

2. Test drive the vehicle. Listen for odd noises or rattles and fix as necessary.

3. If road test is fine, you can now enjoy the added power and performance from your kit.

4. K&N Engineering, Inc., requires cleaning the intake system's air filter element every 100,000 miles. When used in dusty or off-road environments, our filters will require cleaning more often. We recommend that you visually inspect your filter once every 25,000 miles to determine if the screen is still visible. When the screen is no longer visible some place on the filter element, it is time to clean it. To clean and re-oil, purchase our filter Recharger® service kit, part number 99-5050 or 99-5000 and follow the easy instructions.

INTAKE SYSTEMS FOR VEHICLES LISTED ARE 50 STATE LEGAL. SEE KNFILTERS.COM FOR CARB STATUS ON EACH PART FOR A SPECIFIC VEHICLE.