

TYPHOON INTAKE SYSTEMS



INSTALLATION INSTRUCTIONS

69-8753

Toyota RAV4

2000-2005

2.0L 16v 150 bhp

Tools Needed:

10 mm ring spanner
10 mm spanner
Torx 20 screwdriver
flat blade screwdriver
10mm Ratchet, Socket & Extension

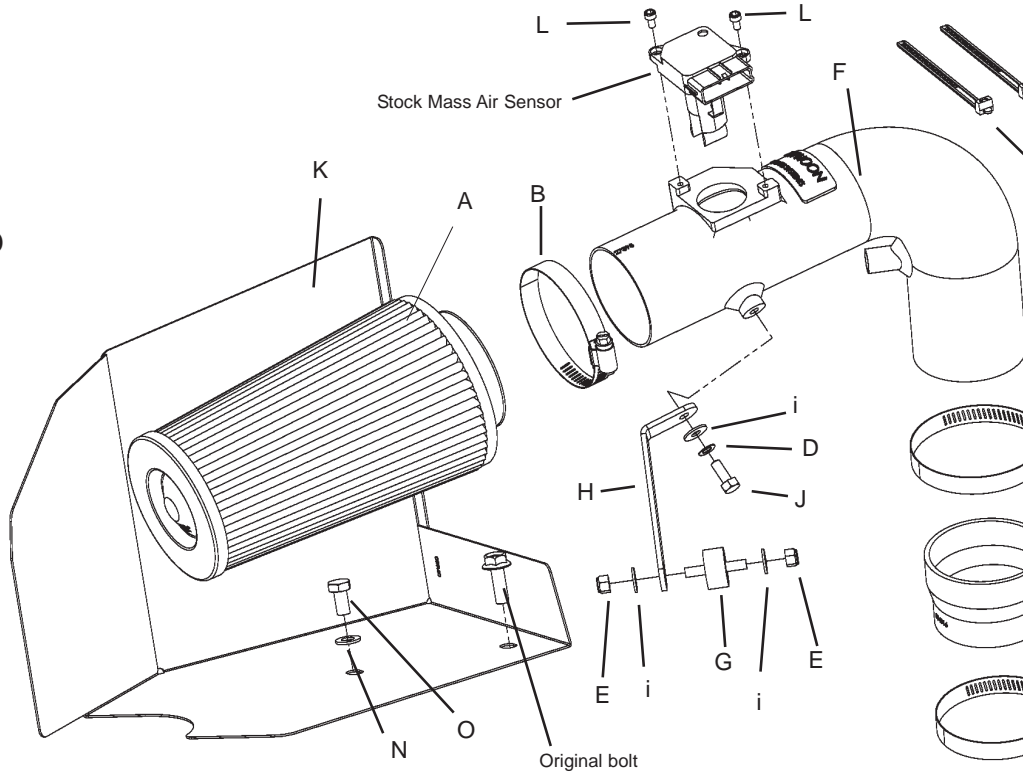

PARTS LIST

Description	Qty.	P/N
A Filter charger	1	RC-5144
B Hose clamp #44	2	08560
C Sleeve black	1	084016
D Washer M6 waved	1	08277
E Nylock nut M6	2	07512
F Intake tube	1	27395
G Rubber stud	1	07027
H Bracket "L"	1	06437
i Washer M6	3	08269
J Bolt M6 x 16mm	1	07812
K Heat shield	1	07620
L Bolt M4 x 8mm	2	07733
M Hose clamp #40	1	08554
N Washer M8	1	08280
O Bolt M8 x 16mm	1	07844
P Cable tie	2	21289

TO START:

1. Turn the ignition OFF and disconnect the vehicle's negative battery terminal.

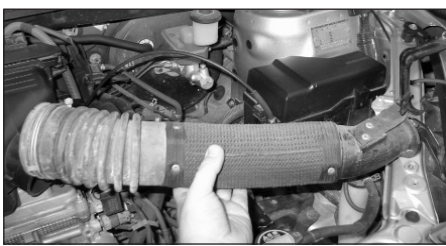

2. Unclip and remove the air inlet duct from the vehicle as shown.



3. Unclip and remove the air box lid from the vehicle as shown.

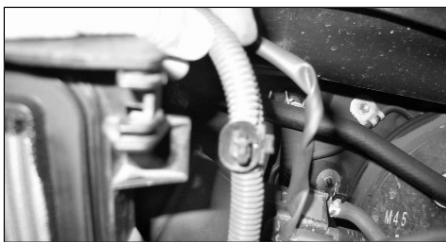

4. Unclip the wire harness from the air box base as shown.



5. Unclip the vacuum switch from the intake tube as shown.



6. Disconnect the mass air sensor (MAS) electrical connection as shown.

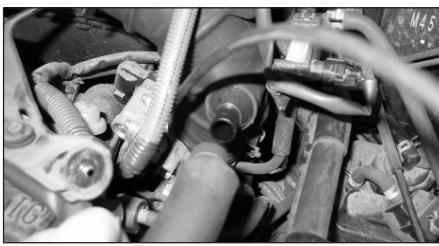

7. Unclip and remove the breather from the intake tube as shown.



8. Loosen the hose clamps at the throttle body and at the air box.



9. Remove the stock intake tube from the vehicle as shown.



10. Loosen and remove the two bolts that secure the air box base to the engine as shown.



11. Remove the air box base from the vehicle as shown.

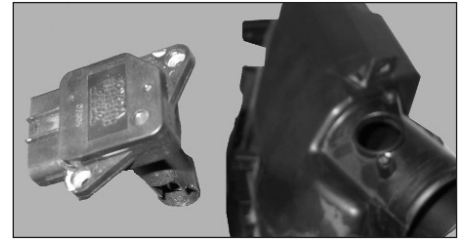

12. Remove the screws from the mass air sensor, then, remove the mass air sensor from the air box as shown.

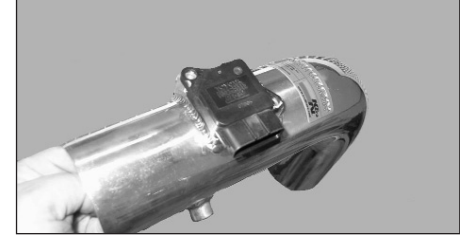

13. Install the MAS into the intake tube using the provided hardware. **NOTE:** Before installing clean the inside of out with water and a towel!



14. Install the silicone step hose and hose clamps supplied onto the throttle body as shown. Do not fully tighten yet!

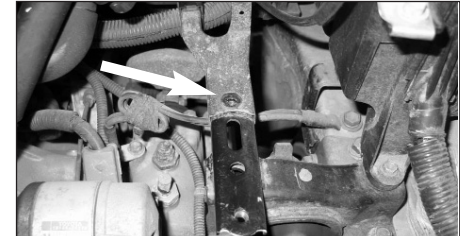

15. Remove the bolt that secures the wire loom bracket to the gear box mounting bracket as shown.



16. Mount the heat shield onto the gear box mounting bracket using the bolt removed in step #15 and one bolt supplied.

Continued on reverse side!



17. Mount the rubber vibration stud onto the gear box mounting bracket using the hardware supplied.

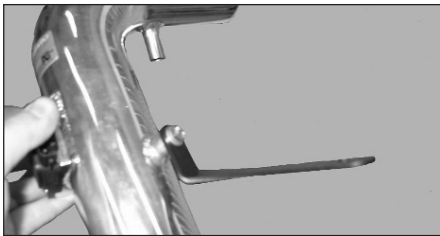

18. Mount the "L" bracket onto the new intake tube using the hardware supplied.



19. Mount the Typhoon tube into the silicone step hose, as shown. Do not fully tighten the hose clamp yet!



20. Mount the "L" bracket onto the rubber vibration stud using the hardware supplied. Do not fully tighten yet!



21. Mount the filter on the new intake tube using the #44 hose clamp supplied.



22. Align the new intake tube for maximum clearance; now firmly tighten all clamps, nuts and bolts.

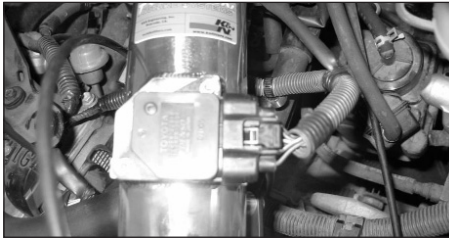

23. Re-connect the mass air sensor electrical connection as shown.



24. Mount the breather hose onto the new intake tube using the original hose clamp as shown.

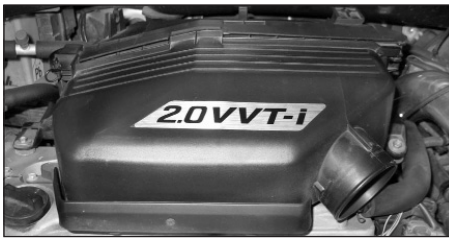

25. Refit the complete air box back onto the engine as shown.

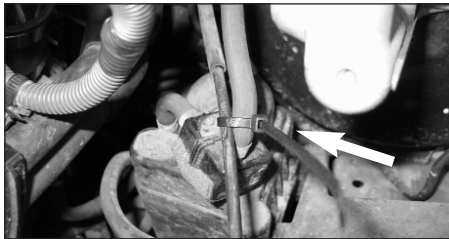

26. Fit the vacuum canister onto the throttle cable using a cable tie supplied.

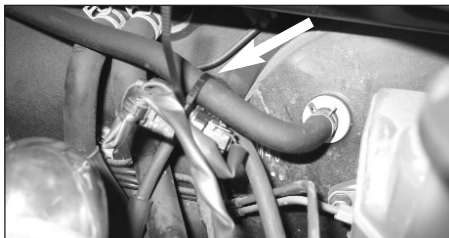

27. Fit the vacuum switch onto the big vacuum hose as shown, using a cable tie supplied.



28. Reconnect the negative battery cable and double check that everything is tight and properly positioned before starting the vehicle.

29. It will be necessary for all Typhoons to be checked periodically for realignment, clearance and tightening of all connections. Failure to follow the above instructions or proper maintenance may void warranty.

NOTE: Before rebuilding the car into the standard set up clean the inside of the air box with water and a towel.



ROAD TESTING:

1. Start the engine with the transmission in neutral or park, and the parking brake engaged. Listen for air leaks or odd noises. For air leaks secure hoses and connections. For odd noises, find cause and repair before proceeding. This kit will function identically to the factory system except for being louder and much more responsive.
2. Test drive the vehicle. Listen for odd noises or rattles and fix as necessary.
3. If road test is fine, you can now enjoy the added power and performance from your kit.
4. K&N suggests checking the Filtercharger element periodically for excessive dirt build-up. When the element becomes covered in dirt (or once a year), service it according to the instructions on the Recharger service kit available from your K&N dealer, part number 99-5003EU