



LEGAL IN CALIFORNIA ONLY FOR RACING VEHICLES WHICH MAY NEVER BE USED, REGISTERED OR LICENSED FOR USE UPON A HIGHWAY. See knfilters.com for CARB status on each part for a specific vehicle

INSTALLATION INSTRUCTIONS

77-9028KP
TOYOTA
2005-06 Tundra
V6-4.0L

NOTE: This kit was not designed to fit vehicles with a body lift.

TOOLS NEEDED:

- Ratchet
- Extension
- 10mm Socket
- Phillips Screwdriver
- 2.5mm Allen
- 10mm Wrench
- 9/64" Allen Wrench

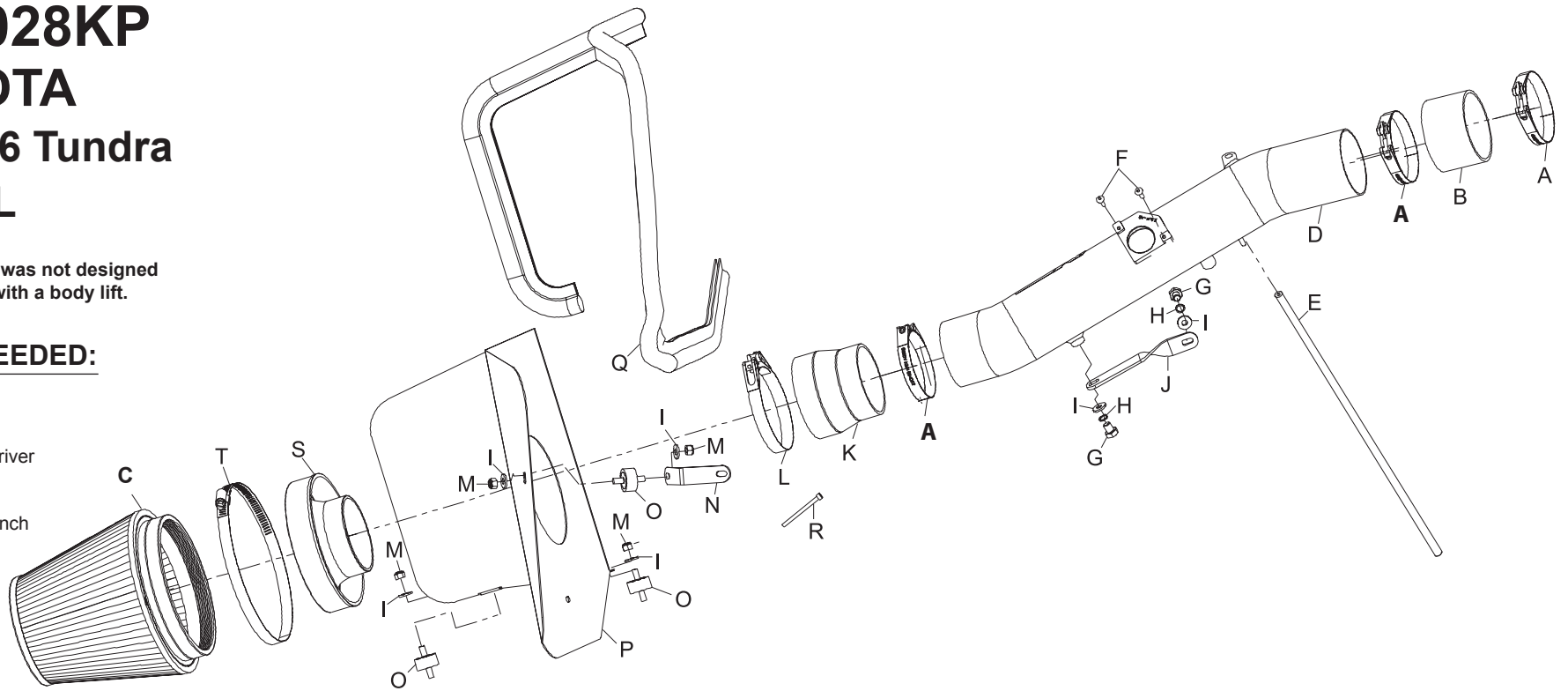

PARTS LIST:

Description	Qty.	Part #	Description	Qty.	Part #	Description	Qty.	Part #
A hose clamp #48	3	08601	H washer; 1/4" id split lock	2	08198	O stud; m6-1.00 m/m rubber mntd	3	07027
B hose; 3" to 2" silicone	1	08434	I washer; 1/4" id x 5/8" od, flat	6	08275	P heat shield	1	07454
C filter	1	RF-1042	J bracket; twist	1	070772	Q edge trim 61"	1	102492
D intake tube	1	27180	K hose; 3" to 3.5" x 3" l tprd	1	084055	R bolt; 8-32 x 2" allen head	1	07751
E hose; 4mmx18" silicone	1	08153	L hose clamp #56	1	08620	S adapter #380	1	21512-1
F bolt; m4-.7 x 16mm, bttm head	2	07793	M nut; m6 nylock	4	07553	T hose clamp #104	1	08697
G bolt; m6-1.00 x 16mm, hex	2	07863	N bracket; "L"	1	070581			

NOTE: FAILURE TO FOLLOW INSTALLATION INSTRUCTIONS AND NOT USING THE PROVIDED HARDWARE MAY DAMAGE THE INTAKE TUBE, THROTTLE BODY AND ENGINE.

TO START:

1. Turn off the ignition and disconnect the negative battery cable.
NOTE: Disconnecting the negative battery cable erases pre-programmed electronic memories. Write down all memory settings before disconnecting the negative battery cable. Some radios will require an anti-theft code to be entered after the battery is reconnected. The anti-theft code is typically supplied with your owner's manual. In the event your vehicles' anti-theft code cannot be recovered, contact an authorized dealership to obtain your vehicles anti-theft code.

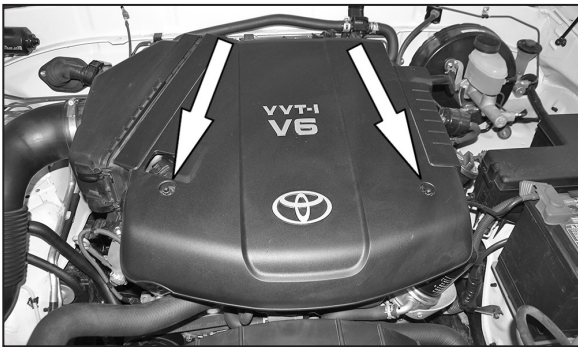

2. Loosen the two nuts that secure the engine cover, and then remove the engine cover from the engine.



3. Loosen the intake tube hose clamp at the air filter assembly.



4. Remove the two bolts which secure the intake resonator to the fender well.



5. Remove the intake tube from the vehicle.



6. Disconnect the two mass air wire harness retaining clips from air box, then disconnect the mass air sensor electrical connection.



7. Remove crank case vent hose from air box as shown.



8. Remove fuel pressure regulator hose from back side of air box.

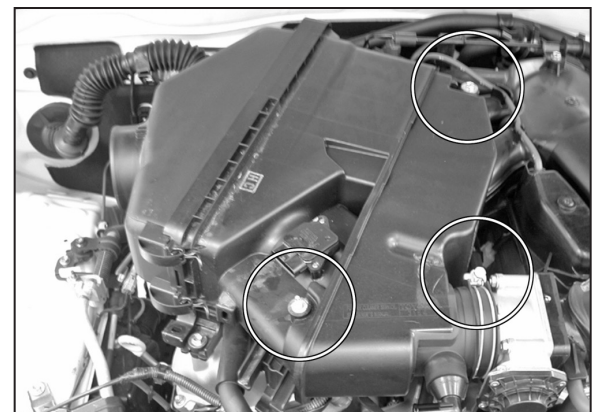

9. Loosen the hose clamp at throttle body, then remove the two bolts that secure air box to engine.



10. Remove air box assembly from engine as shown.

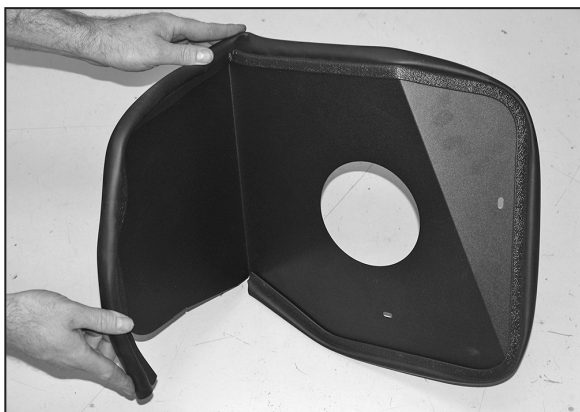

11. Apply the edge trim to the K&N® heat shield as shown above, trim if needed.

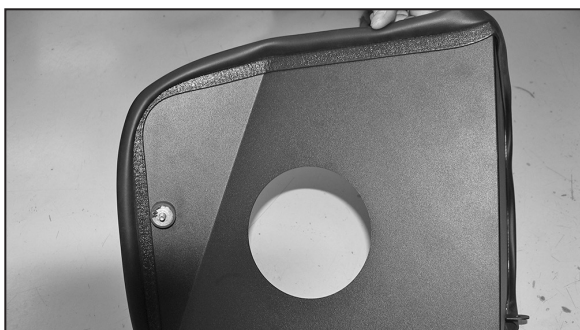

12. Install the rubber mounted stud to the heat shield with the provided hardware, but do not tighten completely at this time.



13. Secure the mounting bracket to the rubber mounted studs to the original air box mounting holes as shown.



14. Install the two remaining rubber mounted studs to the original air box mounting holes as shown.



15. Install the heat shield into the vehicle so that the mounting tabs rest on the rubber mounted studs installed in step #14.



16. Secure the mounting bracket to the fan shroud with the original bolt.



17. Install the silicone hose (08434) onto the throttle body and secure with the provided hose clamp as shown.

NOTE: The synch bolt for the #300 clamp at the throttle body needs to be replaced with the longer bolt supplied.



18. Remove the two screws that secure the mass air sensor to the air box assembly, then remove the mass air sensor as shown.

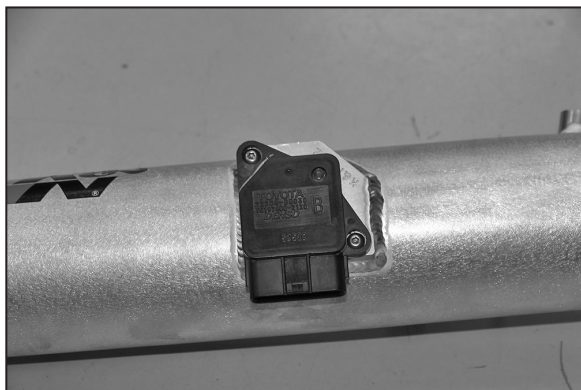

19. Install the mass air sensor into the K&N® intake tube with the hardware provided.

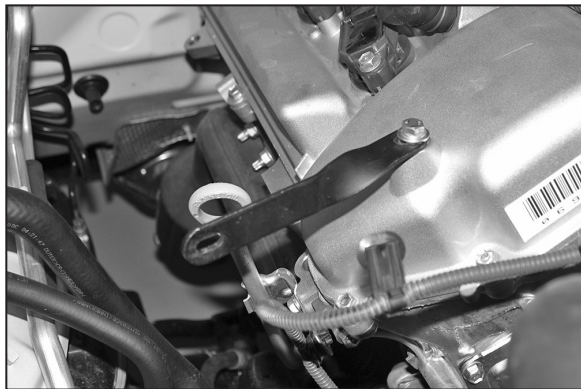

20. Install the tube mounting bracket onto the threaded boss on the valve cover with the provided hardware as shown.

NOTE: Do not tighten completely at this time.

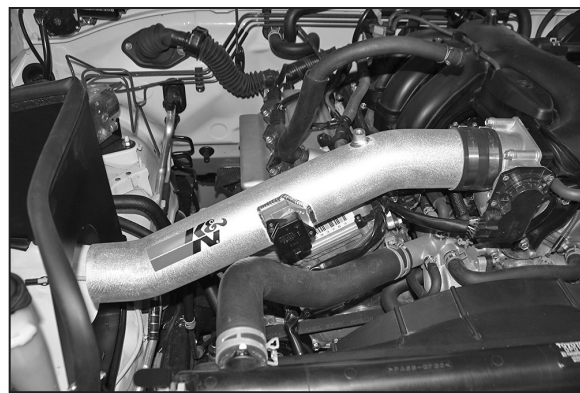

21. Install the K&N® intake tube into the silicone hose at the throttle body and align the mounting stand off with the bracket installed in step #20. Secure the intake tube with the hose clamp and hardware provided.



22. Remove the crank case vent hose from the valve cover and then remove the factory clamp and outer cover from the crank case vent hose as shown.

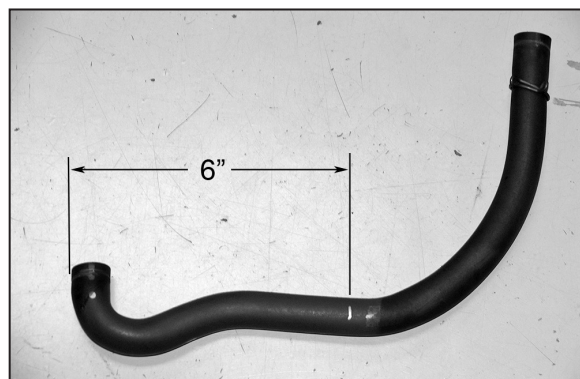

23. Measure 6" from the end of the crank case vent hose as shown and cut the hose.

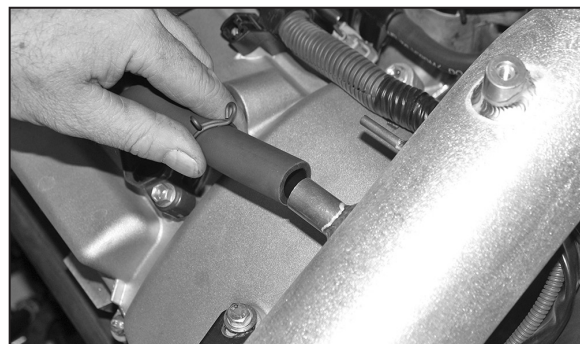

24. Reinstall the crank case vent hose into the valve cover and then connect the cut end to the K&N® intake tube as shown. Secure the vent hose with the factory spring clamps.

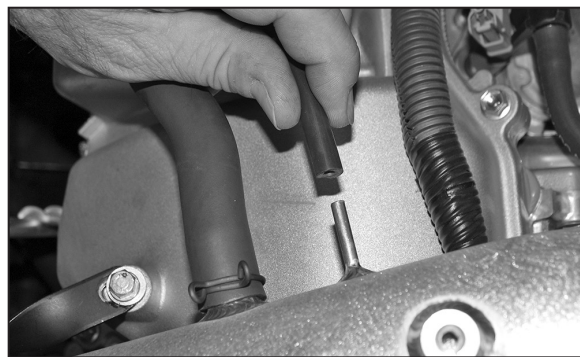

25. Remove the stock vacuum hose from the fuel pressure regulator, then install the provided silicone hose to the fuel pressure regulator and then onto the K&N® intake tube as shown.



26. Install the filter adapter into the Air Filter as shown.



27. Install the silicone hose (084055) onto the Air Filter assembly as shown and secure with the provided hose clamp.

NOTE: Drycharger® air filter wrap; part # RF-1042DK is available to purchase separately. To learn more about Drycharger® filter wraps or look up color availability please visit <http://www.knfilters.com>.



28. Install the Air Filter assembly onto the K&N® intake tube and secure with the provided hose clamp.



29. Using a pair of pliers, remove the engine cover-mounting stud shown from the factory air box.



30. Install the engine cover mounting stud into the threaded stand off on the K&N® intake tube as shown.



31. Using the provided template, mark the trim lines onto the engine cover and then cut with the appropriate tool.

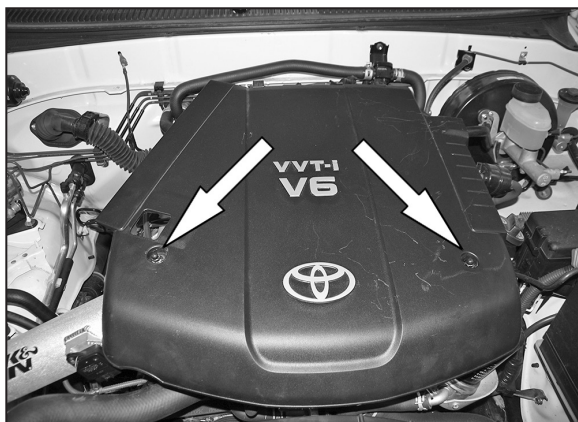

32. Install the engine cover and secure with the factory mounting nuts removed in step #2.



33. Reconnect the mass air sensor electrical connection.

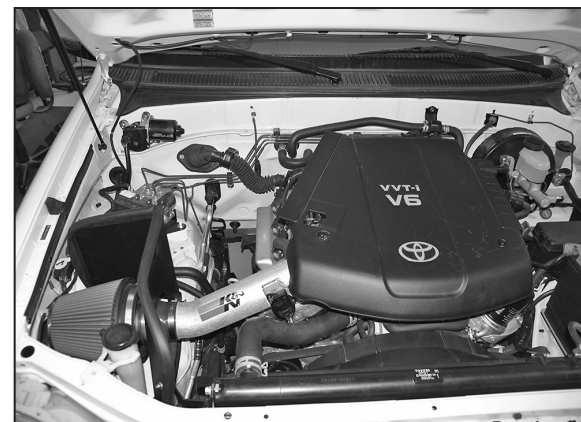

34. Reconnect the vehicle's negative battery cable. Double check to make sure everything is tight and properly positioned before starting the vehicle.

35. It will be necessary for all K&N® high flow intake systems to be checked periodically for realignment, clearance and tightening of all connections. Failure to follow the above instructions or proper maintenance may void warranty.

ROAD TESTING:

1. Start the engine with the transmission in neutral or park, and the parking brake engaged. Listen for air leaks or odd noises. For air leaks secure hoses and connections. For odd noises, find cause and repair before proceeding. This kit will function identically to the factory system except for being louder and much more responsive.

2. Test drive the vehicle. Listen for odd noises or rattles and fix as necessary.

3. If road test is fine, you can now enjoy the added power and performance from your kit.

4. K&N Engineering, Inc., requires cleaning the intake system's air filter element every 100,000 miles. When used in dusty or off-road environments, our filters will require cleaning more often. We recommend that you visually inspect your filter once every 25,000 miles to determine if the screen is still visible. When the screen is no longer visible some place on the filter element, it is time to clean it. To clean and re-oil, purchase our filter Recharger® service kit, part number 99-5050 or 99-5000 and follow the easy instructions.

LEGAL IN CALIFORNIA ONLY FOR RACING VEHICLES WHICH MAY NEVER BE USED, REGISTERED OR LICENSED FOR USE UPON A HIGHWAY.

See knfilters.com for CARB status on each part for a specific vehicle

Cut out along the dotted line and use template for step #31.

