

## LS Classic Series By Lokar LS3 Distributor and Plug Wires Installation Instructions

Building American Quality... With A Lifetime Warranty!®

TOLL FREE 1-877-469-7440 • tech@lokar.com • www.lokar.com

### LS Classic Series By Lokar LS3 Distributor and Plug Wires Installation Instructions

#### General Installation Notes:

Please read these instructions completely before beginning the installation. If you have any questions, please call.

Before beginning the installation, disconnect the negative battery cable and use wheel chocks to block the vehicle's wheels.

Make sure the engine, transmission, body and frame are properly grounded. We recommend using anti-seize lubricant on all aluminum threads.

Refer to Fig. 1 for the component names. Fig. 2 shows the order of assembly and orientation of the components.

**NOTE:** This Distributor and Plug Wire Kit will **NOT** work with a stock Gen IV (or other) valley plate with a raised oil pressure sensor boss.

The ignition coils should be mounted on the vehicle before installing the Distributor and Plug Wires.

You will need a spark plug wire crimper in order to complete this installation.

Before beginning the installation, decide how you are going to arrange the plug wires coming out of the top of the distributor cap. Some may want to follow the original engine firing order, and others may want the left side of the cap to feed the left side of the engine (and vice versa) for a neater appearance.

**GM applications only:** Most will want the points adjustment window on the distributor cap to face forward, but with a "57 Fuelie", a "62 Fuelie", or a "63 Fuelie" intake manifold, the points adjustment window must face the rear of the engine.

**Ford applications only:** The distributor housing should be installed with the vacuum advance canister pointing to the front.

**Step 1:** The plug wires already have the coil ends installed. Install a plug wire onto the #1 ignition coil.



Fig. 1

**Step 2: Ford Only:** Feed the bare end of the plug wire from the rear of the engine underneath the intake manifold to the front of the engine.

**All:** Feed the bare end of the plug wire up through the bottom of the distributor housing and out through the top.

**Step 3:** Feed the plug wire up into the bottom of the distributor cap and out through the desired #1 tower.

**Step 4:** Use masking tape and a permanent marker to label the distributor cap tower you used as #1.

**\*\* Only one distributor comes with each kit \*\***

**Step 5:** Repeat with the remaining 7 plug wires, labeling each distributor cap tower with the cylinder number before starting on the next one. For the last couple of plug wires, spray silicone lubricant on the plug wires to make it easier to slide them through the distributor housing.

**Step 6: GM applications:** Remove the two rear bolts from the engine's valley plate (one bolt on each side).

**Ford applications:** Remove the two front bolts from the engine's valley plate (one bolt on each side).

**Step 7:** Feed the bundle of plug wires through the distributor housing as far as is needed in order to place the distributor housing onto the engine's valley plate, with the plug wire opening at the bottom facing rearward and the bolt slots in the distributor housing aligned with the valley plate bolt holes. Use more silicone spray lubricant if necessary to help the plug wires slide through the distributor housing.

**Step 8:** Use the provided M8-1.25 x 40mm hex head bolts with flat washers (GM applications) or M8-1.25 x 25mm button head bolts (Ford applications) to bolt the distributor housing to the engine. Torque the bolts to 18 lb.-ft.

**Step 9:** Feed each of the plug wires through the distributor cap as far as is needed to install the distributor cap onto the distributor housing and latch it into place.

**Step 10:** Route the #1 plug wire to the #1 spark plug. Make sure that the plug wire is not pulled tight, and that it will not be against the exhaust or be too close to any moving parts. Mark the plug wire where it meets the spark plug.

**Step 11:** Cut the plug wire at your mark, using a pair of sharp wire cutters or a sharp utility knife.

**Step 12:** Spray silicone lubricant on the end of the plug wire. Feed the plug wire into the large end of a distributor cap boot and out of the small end. Slide the distributor cap boot into place on the distributor cap. **Fig. 3 & Fig. 4**

**Step 13:** Spray silicone lubricant on the end of the plug wire again if needed. Feed the plug wire into the large end of a spark plug boot and out of the small end. Slide the spark plug boot a couple of inches up the plug wire towards the distributor cap.

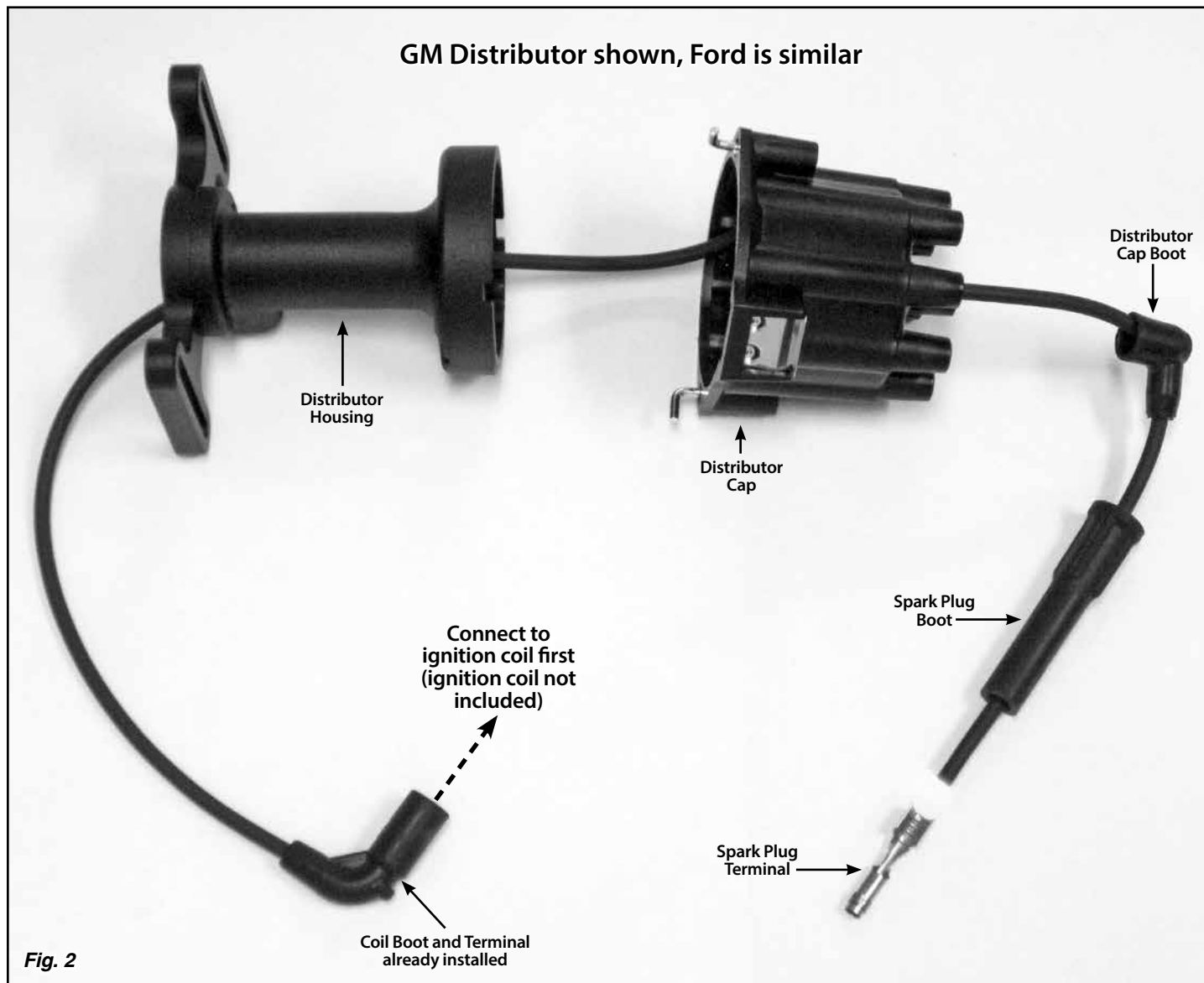

**Step 14:** Measure and make a mark 5/8" from the end of the plug wire. **Fig. 5** Use a sharp utility knife to CAREFULLY cut through the black outer cover and approximately 1/16" into the insulation, all the way around the plug wire. MAKE SURE you do not cut the insulation deep enough to reach the conductor in the center of the plug wire!

**Step 15:** Bend the cut section back and forth a few times to break the insulation free from the conductor core in the plug wire. Pull the insulation off of the plug wire, leaving 5/8" of the conductor sticking out. **Fig. 6**

**Step 16:** Inspect the conductor closely to make sure you did not nick it with the knife. If there is **ANY** damage to the conductor, you must cut the conductor off flush with the insulation, and strip the plug wire end again, more carefully.

## GM Distributor

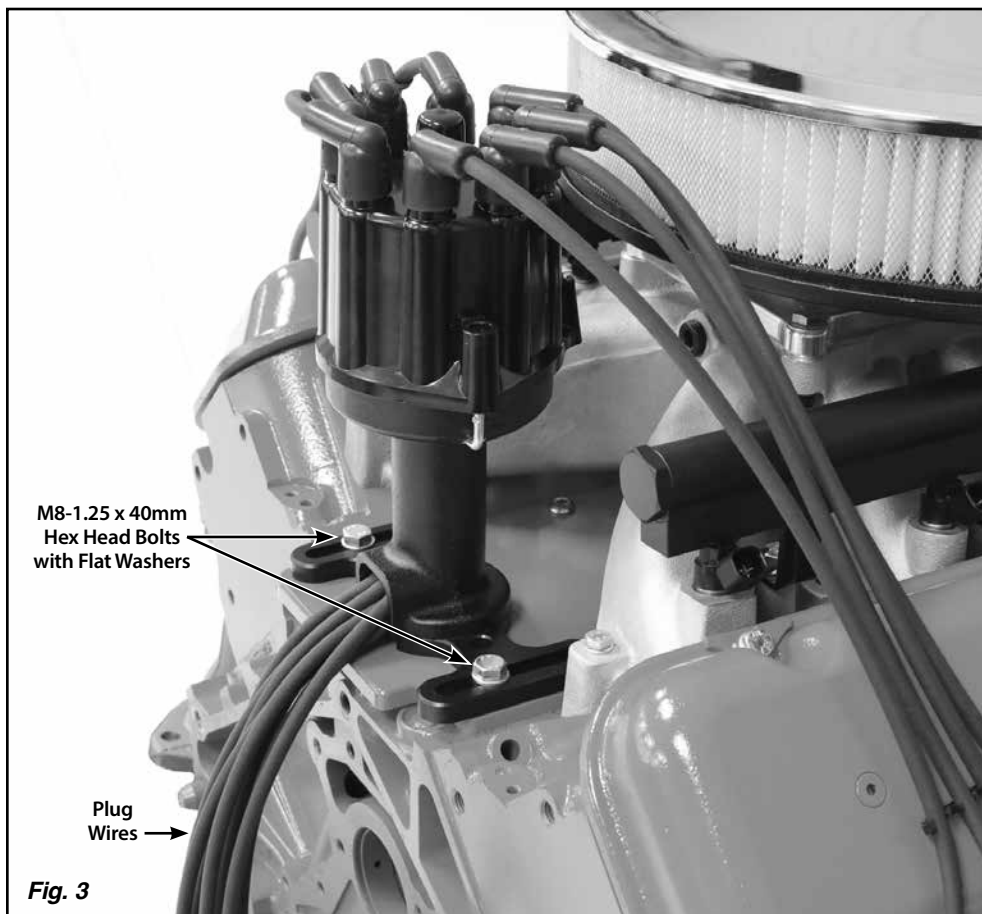

## Ford Distributor

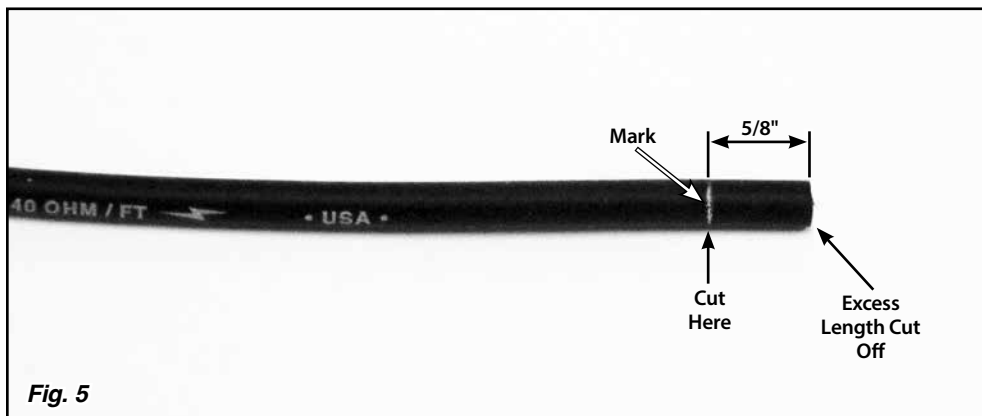

**Step 17:** Fold the conductor over against the outside of the insulation. **Fig. 7** Position a spark plug terminal on the end of the plug wire, with the conductor on the bottom in between the insulation and the back of the spark plug terminal. Make sure that the terminal is positioned so that at least 1/16" or a little more of the insulation is protruding beyond the edge of the tabs on the spark plug terminal. **Fig. 8**

**Step 18:** Before you start to crimp the spark plug terminal, use a pair of pliers to squeeze the spark plug terminal tabs together enough to keep the terminal from falling off of the plug wire, and so that the tabs will fit into the notches on the spark plug wire crimper. **Fig. 8**

**Step 19:** Use the spark plug wire crimper to crimp the terminal onto the plug wire. **Fig. 9**

**Step 20:** Spray the plug wire with silicone lubricant again, and carefully slide the spark plug boot back down the plug wire and over the spark plug terminal until you feel it stop. **Fig. 10**

**Step 21:** Repeat the above process for the other seven plug wires.

**Step 22:** Once the silicone lubricant has had a chance to dry, install each of the plug wires onto their respective spark plugs. Remove the masking tape labels from the distributor cap.

**Step 23:** If you wish to install a vintage style coil and coil wire for appearance purposes only, you may use the remaining distributor cap boots and decorative coil wire. Push the small end of a distributor cap boot onto the decorative coil wire.

**Step 24:** Install the decorative coil wire onto the center terminal of the distributor cap. Route the coil wire to a decorative, non-functional coil (not included), and mark the decorative coil wire where it meets the coil terminal.

**Step 25:** Use a sharp knife or wire cutters to cut the decorative coil wire at your mark. Push the remaining distributor cap boot onto the end of the decorative coil wire, and install it onto the decorative coil.

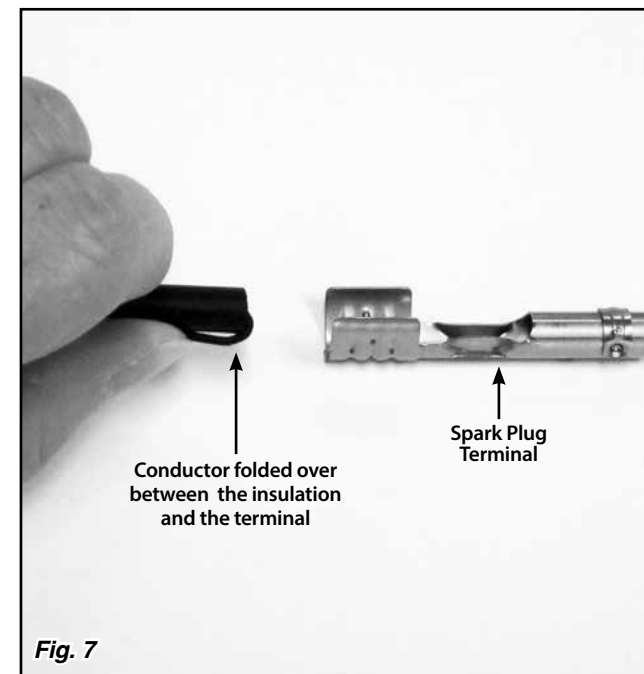

**Fig. 7**

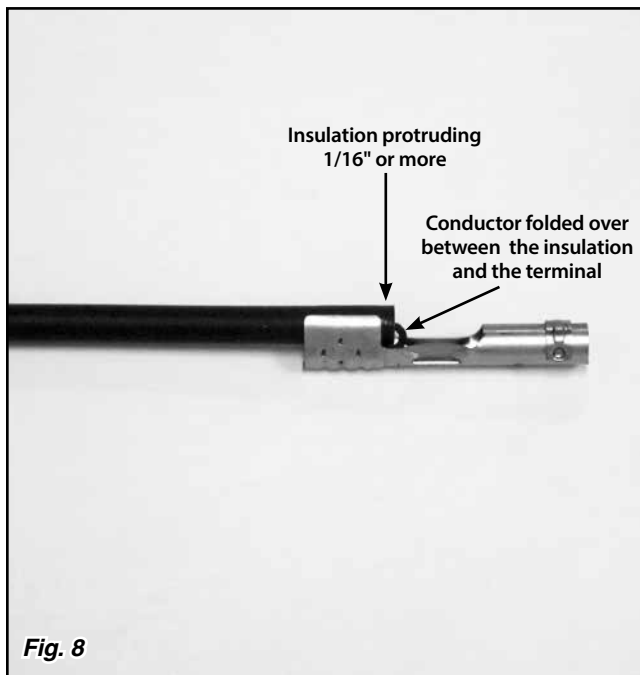

**Fig. 8**

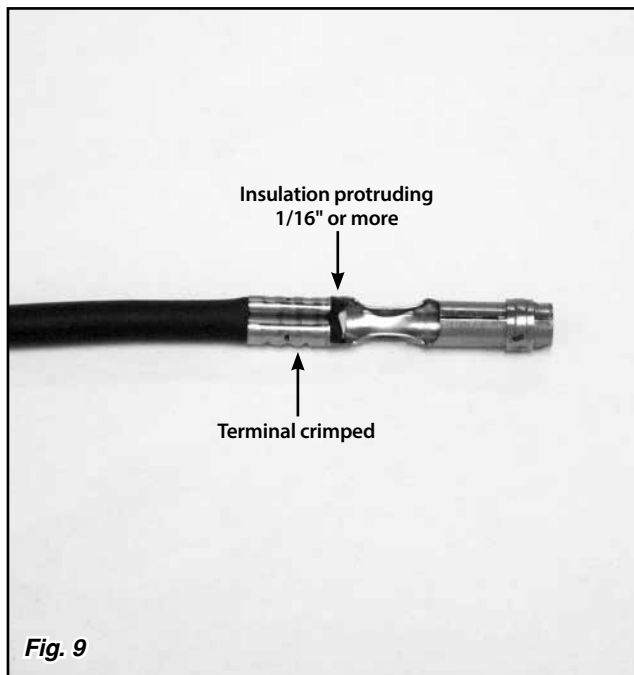

**Fig. 9**

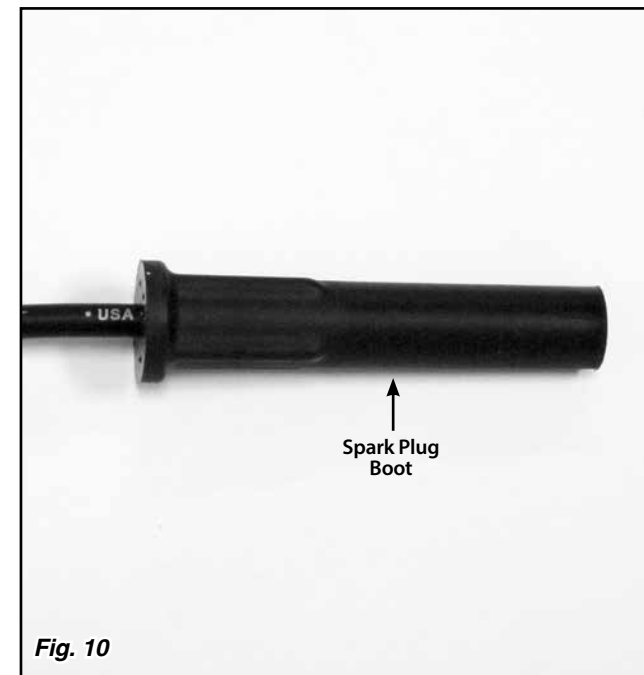

**Fig. 10**