

2010 Hyundai Genesis 2.0L Coupe

Warning: When working on, under, or around any vehicle exercise caution. Please allow the vehicle's exhaust system to cool before removal, as exhaust system temperatures may cause severe burns. If working without a lift, always consult vehicle manual for correct lifting specifications. Always wear safety glasses and ensure a safe work area. Serious injury or death could occur if safety measures are not followed.

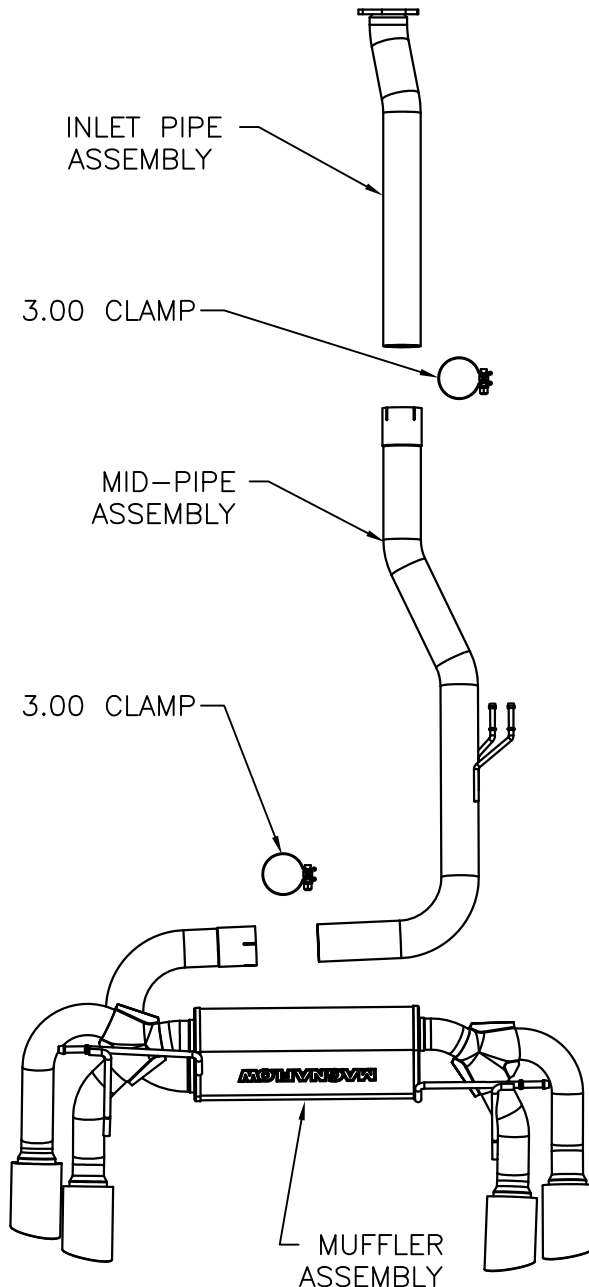

Step 1: (Carefully read all instructions before installation) Begin removal of the OEM exhaust by unbolting the front Resonator Assembly at the front flange behind the Catalytic Converter and the rear flange at the Muffler Assembly. Working front to rear disengage the welded hangers from the rubber insulators and extract the exhaust system from the vehicle. Do not discard the OEM fasteners or damage the rubber insulators, as they will be used to mount the new system

Step 2: Install the Inlet Pipe Assembly by using the OEM fasteners at the front flange, install the Mid-pipe Assembly using the supplied 3.0" clamp and the OEM rubber insulators for the hangers. Leave all clamps loose for final adjustments of the complete system. Using the supplied 3.00" clamp, install the Muffler Assembly and insert the welded hangers into the OEM rubber insulators.

Step 3: With all components mounted loosely, adjust the system for overall aesthetics and clearance of frame & bodywork. (MAGNAFLOW recommends at least 1/2" of clearance between the exhaust system and any body panels to prevent heat-related body damage or fire.)

Step 4: Once a final position has been chosen for the new system, evenly tighten all fasteners from front to rear. The supplied band clamps must be VERY tight to properly align the pipes and prevent leaks (Approximately 65ft-lbs). Inspect all fasteners after 25-50 miles of operation and retighten if necessary.

*MAGNAFLOW Performance Exhaust recommends professional installation on all their products

Technical support: 1-800-959-9226 ext. 4500

MAGNAFLOW Performance Exhaust - 22961 Arroyo Vista - Rancho Santa Margarita, CA 92688