

2006 VW Golf 2.0T MK5

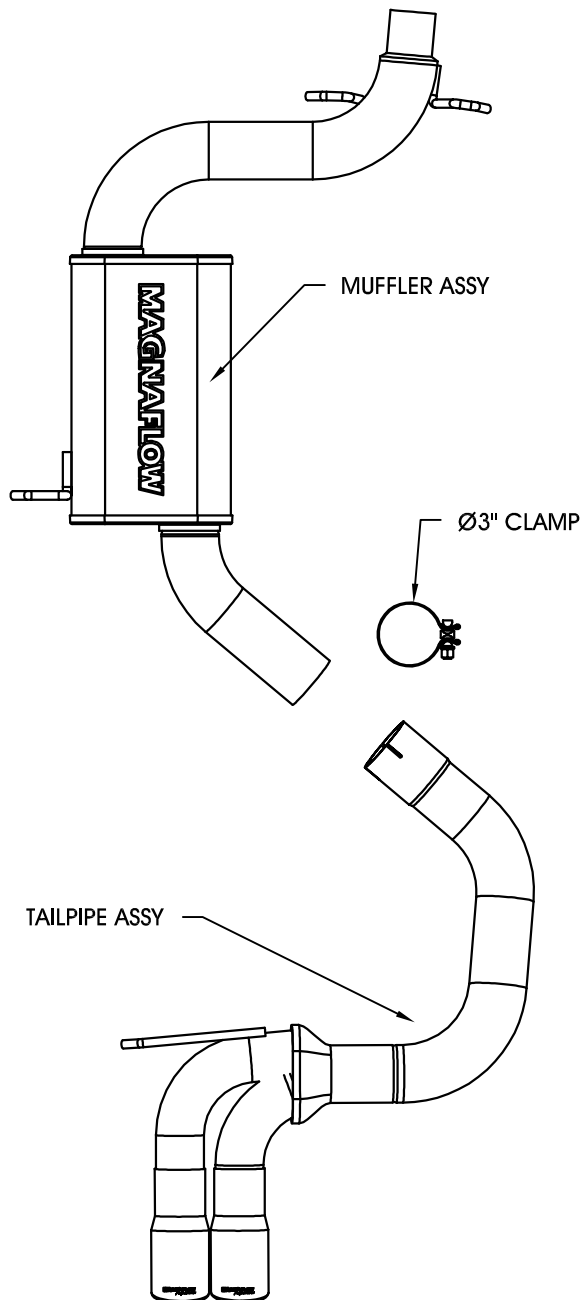

Warning: When working on, under, or around any vehicle exercise caution. Please allow the vehicle's exhaust system to cool before removal, as exhaust system temperatures may cause severe burns. If working without a lift, always consult vehicle manual for correct lifting specifications. Always wear safety glasses and ensure a safe work area. Serious injury or death could occur if safety measures are not followed.

Step 1: (Carefully read all instructions before installation) Disconnect the vehicle's battery before removal of the OEM exhaust. This will allow the computer to reset itself with the new system, and prevent electrical accidents. Begin removal of the OEM exhaust system by loosening the OEM clamp located behind the catalyst converter. Do not damage or discard the OEM clamp nor rubber insulators, as they will be reused to mount the new system. Disengage the welded hangers from the OEM rubber insulators and remove the entire OEM exhaust system.

Step 2: Install the new exhaust system by using a front to rear method. Using the OEM clamp, install the muffler assembly, then insert the welded hangers into the OEM rubber insulators. Leave all clamps loose for the final adjustment of the complete system. Using the supplied 3" clamp, install the tailpipe assembly in a similar fashion.

Step 3: With all components mounted loosely, adjust the system for overall aesthetics and clearance of frame & bodywork. (MAGNAFLOW recommends at least 1/2" of clearance between the exhaust system and any body panels to prevent heat-related body damage or fire.)

Step 4: Once a final position has been chosen for the new system, evenly tighten all fasteners from front to rear. The supplied band clamps must be VERY tight to properly align the pipes and prevent leaks (Approximately 65ft-lbs). U-bolt clamps should be tightened to approximately 30-35ft-lbs. Inspect all fasteners after 25-50 miles of operation and retighten if necessary.

*MAGNAFLOW Performance Exhaust recommends professional installation on all their products

Technical support: 1-800-959-9226 ext. 4500

MAGNAFLOW Performance Exhaust - 22961 Arroyo Vista - Rancho Santa Margarita, CA 92688