

INSTALLATION INSTRUCTIONS FOR 15964/15975/ 16901/16903

2001 - SILVERADO/SIERRA 2500HD/3500 6.6L V8 CC/SB DUALS

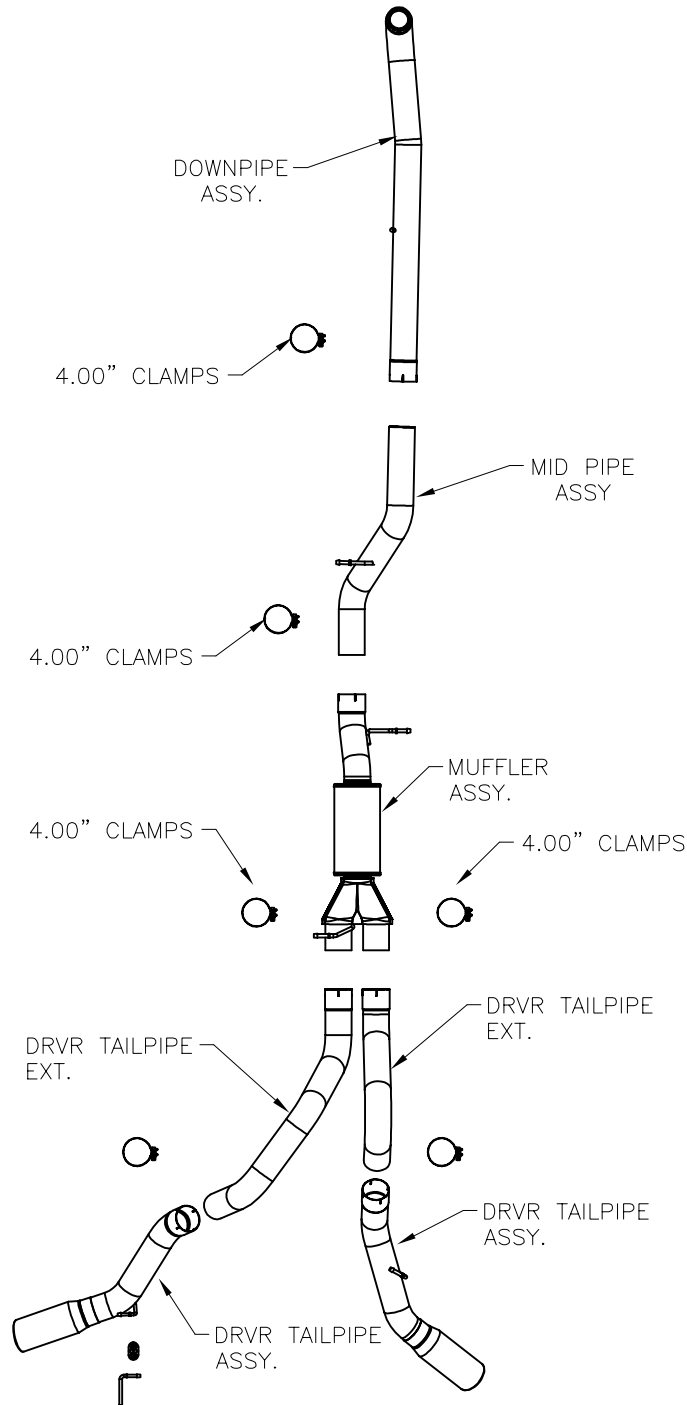

Note: MAGNAFLOW advises against the removal of catalytic converters. If the vehicle was originally equipped with a catalytic converter, this exhaust system is intended for off-road and racing applications only.

Warning: When working on, under, or around any vehicle exercise caution. Please allow the vehicle's exhaust system to cool before removal, as exhaust system temperatures may cause severe burns. If working without a lift, always consult vehicle manual for correct lifting specifications. Always wear safety glasses and ensure a safe work area. Serious injury or death could occur if safety measures are not followed.

Step 1: (Carefully read all instructions before installation) Disconnect the vehicle's battery before removal of the OEM exhaust. This will allow the computer to reset itself with the new system, and prevent electrical accidents. Remove the OEM exhaust system by unbolting the flanges starting at the turbo, and by disengaging the welded hangers from the OEM rubber insulators. Do not discard the OEM V-band clamp or fasteners, as they will be reused to mount the new system. To aid in removal of the system, the tailpipe can be cut from the muffler body.

Step 2: Begin installation by fastening the new downpipe to the turbo reusing the OEM V-band clamp. Leave all clamps and fasteners loose for final adjustment of the complete system. Working rearward, install the extension pipe assemblies and muffler as shown using the supplied 4" clamps and by fitting the welded hangers into the OEM rubber insulators. An adjustable threaded hanger is supplied to support the driver's tailpipe by being bolted into a pre-drilled hole on the frame of the vehicle as shown in Diagram 2.

*MAGNAFLOW Performance Exhaust recommends professional installation on all their products

Technical support: 1-800-959-9226 ext. 4500



INSTALLATION INSTRUCTIONS FOR 15964/15975/ 16901/16903

2001 - SILVERADO/SIERRA 2500HD/3500 6.6L V8 CC/SB DUALS

DIAGRAM 2



Note: MAGNAFLOW advises against the removal of catalytic converters. If the vehicle was originally equipped with a catalytic converter, this exhaust system is intended for off-road and racing applications only.

Warning: When working on, under, or around any vehicle exercise caution. Please allow the vehicle's exhaust system to cool before removal, as exhaust system temperatures may cause severe burns. If working without a lift, always consult vehicle manual for correct lifting specifications. Always wear safety glasses and ensure a safe work area. Serious injury or death could occur if safety measures are not followed.

Step 3: With all components mounted loosely, adjust the system for overall aesthetics and clearance of frame & bodywork. (MAGNAFLOW recommends at least 1/2" of clearance between the exhaust system and any body panels to prevent heat-related body damage or fire.)

Step 4: Once a final position has been chosen for the new system, evenly tighten all fasteners from front to rear. The supplied band clamps must be VERY tight to properly align the pipes and prevent leaks (Approximately 65ft-lbs). U-bolt clamps should be tightened to approximately 30-35ft-lbs. Inspect all fasteners after 25-50 miles of operation and retighten if necessary.

**MAGNAFLOW Performance Exhaust recommends professional installation on all their products*

Technical support: 1-800-959-9226 ext. 4500

MAGNAFLOW Performance Exhaust - 22961 Arroyo Vista - Rancho Santa Margarita, CA 92688