



## INSTALLATION INSTRUCTIONS

### IMPORTANT:

Please read all instructions before beginning installation. These guidelines are provided in good faith to help prevent any issues arising from errors during installation. The manufacturer of this product shall not be held responsible for any user actions taken or not taken during installation. There are many details of the installation that are assumed to be general mechanical knowledge to experienced installers; which are not detailed in these instructions. These installation guidelines are intended to serve as professional recommendations and are not as a step-by-step, fail-safe installation checklist. Selection of an experienced installer is the sole responsibility of the project owner.



KC M-Rack Shown with lights

### Parts Included: (Lights are sold separately)

KC M-Rack:	Front Light Bar:	Chase Bar:	Side Lights:
A - Driver side - Support Rail (1)	A - KC Led Light Bar (1)	A - 28" KC Rear Chase Bar	A - 10" KC LED Side Light
B - Pass. Side - Support Rail (1)	B - M8 Socket cap (2)	B - 1/4-20 Carriage Bolts (4)	B - 1/4-20 Carriage Bolts (4)
C - Extruded Cross Bars (5)	C - M8 washer (2)	C - 1/4-20 Hex Bolts (4)	C - 1/4-20 nut (4)
D - M-Racks Logo Plate (2)		D - 1/4-20 nut (8)	D - Side light bracket (2)
E - Blind Rivets (8)		E - Rear light bracket (2)	
F - M6 Rivnut (10-14)			
G - Button Head Allen Cap Screw (20)			
H - 1/4" Washer flat (20)			
I - M6 Button cap screw			

\*can hold a total of 4 side lights

# KC M-RACK GENERAL INSTALLATION GUIDELINES

## TOOLS NEEDED FOR INSTALLATION

For this installation you will need Allen wrenches, a 3/8 wrench or socket, blind rivet tool, rivnut tool, Drill w/ sharp bits (1/16" & "Q"), & a center punch.

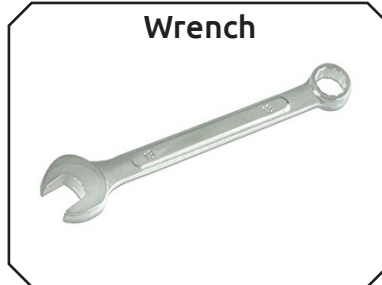
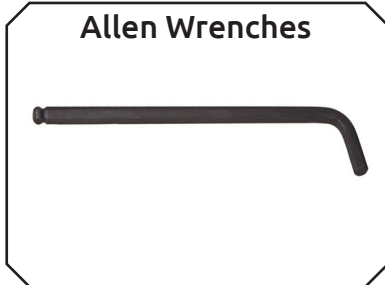

## STEP BY STEP INSTALLATION INSTRUCTIONS

- 

**Support Rail to Cross Bar Assembly**  
*(It is recommended that the assembly be done off the vehicle, "up-side-down" on a flat surface.)*

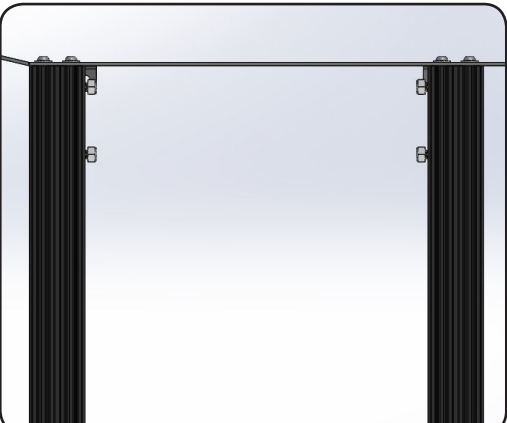
Starting with either Support Rail, begin by loosely fastening the extruded cross bars using the supplied 1/4 -20 button allen-cap screws and 1/4" washers (2x screws & washers per cross bar). With the cross bars square to the top of the rail, torque down until tight. (Blue thread-locker is recommended)
- 

**Side Light Mounting Option**  
*Whether or not Side Lights are being installed, doing this step will save a lot time for future installs. The rear chase bar also uses 4 carriage bolts on the rear-most extrusion channel.*

Each Side Light Mounting Bracket(s) will require (2) carriage bolts to mount into position. Begin by sliding the carriage bolts into position from the open end of the extruded cross bars, as shown in the image.

***Due to manufacturing tolerances of the hardware, some of the carriage bolts will slide easier than the others. One side will slide easier than the other.***

# KC M-RACK GENERAL INSTALLATION GUIDELINES

## 3. Attach the Second Support Rail

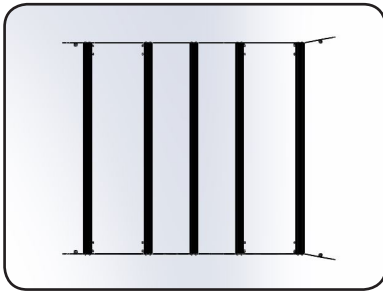

After all the desired carriage bolts have been installed, fasten the remaining side rail to the extruded cross bars, as done so in Step #1. Once attached, ensure all screws are securely fastened. Once completed the rack is now fully assembled.

## 4. Mask off Roof of the Vehicle

Carefully mask off the area where the M-Rack is going to be installed. Provide plenty of coverage to prevent any surfaces of the vehicle from getting damaged during rack placement. Be sure to select tape that will not damage the paint or leave behind any excess adhesive residue.

## 5. Marking Drill Hole Positions

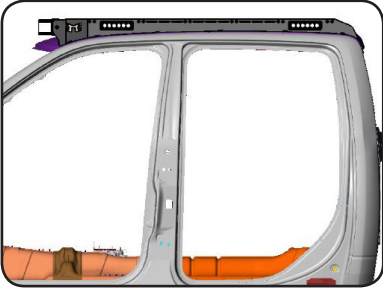

Align and center the rack into place on the vehicle. Once the placement of the rack is satisfactory, mark the mounting locations onto the masking tape by tracing the tab and the hole. Remove the rack from the vehicle and set aside. (Remember: "Measure Twice, Cut Once") Double-check that the rack is centered and that the marks are in the correct location.

## 6. Drilling the Mounting Holes

Before drilling, use a center punch to pin-point your pilot hole position. Use a 1/16" drill bit (or similar size) to start a pilot hole in the center of each tab mark. **Be careful not to drill beyond the outer roof skin;** a drill stop can be used to set the depth. Open up the pilot holes using a "Q" size drill bit (a 5/16" bit will also work, but is not ideal). Again, closely monitor the depth to make sure that the bit does not pierce the second layer of the roof.

## 7. Rivnut Installation

After clearing holes of extra burrs, place the self-sealing rivnut inserts into the newly created holes. Using a rivnut tool with an M6 die set the rivnuts, and ensure that they are securely fastened. The rivnuts will self-seal so long as they are seated and crushed properly.

## 8. Fasten the Rack



*Note: Before attaching the rack to the vehicle, if there are lights that need to be installed, this would be a good time to do so. (See Step #10)*

Set the rack back into position atop the vehicle. Using the supplied M6-1.0 button head cap-screws and washers, attach the rack onto the OEM holes and/or newly installed rivnut (Blue thread-lock is recommended, but not required).

## KC M-RACK GENERAL INSTALLATION GUIDELINES

9.



### Installing the M-Racks Logo Plates

Line up the M-Racks Logo Plate with the 4-holes on the front section of the Support Rails. Use the supplied rivets and a blind rivet tool to attach the Logo. Note: the M-Rack Logo plates ship loose and unfinished to make customized finishing easy.

10.

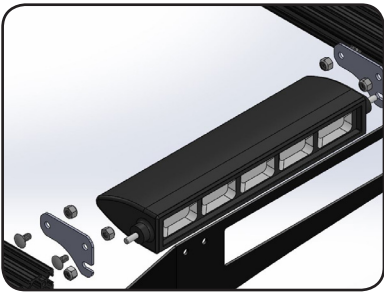

### Attach the Side Lights (Optional)

Attach the side light mounting plates onto the carriage bolts that were previously installed on the side channels of the extrusion. Thread the nuts onto the stud that is attached to the 10" light. Aim and position the lights to the desired location, and securely tighten the hardware to lock the lights in place.

11.

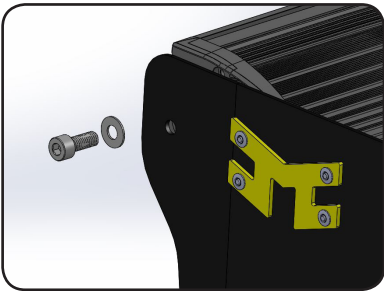

### Attach the Light Bar (Optional)

Holding the light bar in place, thread the socket cap screw and fasten the light into position. Be sure to aim the lights to the desired location before tightening down (this works best at night). For a Pro6 Installation, please refer to the Pro6 instruction manual.

12.

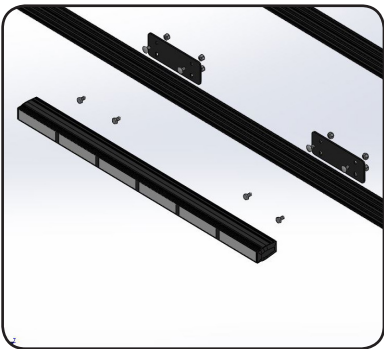

### KC Rear Chase Bar (Optional)

Fit the Rear Chase Bar bracket onto the previously installed carriage bolts on the rear extruded cross bar. Hand-tighten the 1/4-20 nuts to hold the brackets in position. Install the 1/4" hex bolts into the KC Rear Chase Bar by removing the end cap and sliding the hex head into the extruded channel. Re-install the end cap and position the 1/4" hex bolts into the Chase Bar brackets. Once the light is in the desired position, securely fasten the Rear Chase Bar.

## PRODUCT REGISTRATION

Thank you for becoming part of the KC HiLiTES family and purchasing one of our premium KC products! With over 45 years of history in the auxiliary lighting market, you have become a part of our ever growing family, and we encourage you to register your product online at [HTTP://REGISTER.KCHILITES.COM](http://REGISTER.KCHILITES.COM) to ensure you get all the benefits of owning a KC HiLiTES product.