

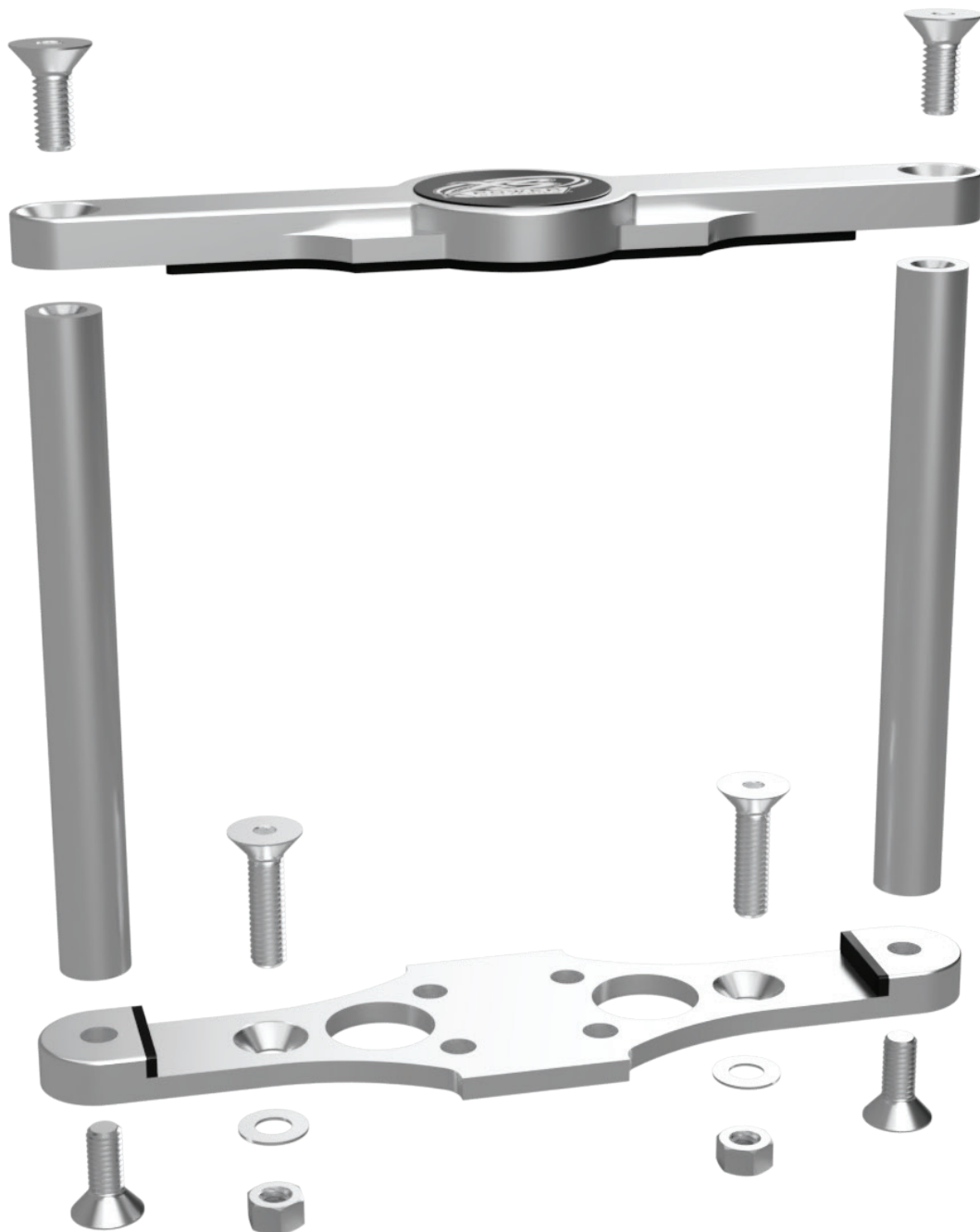

HOLD DOWN ASSEMBLY INSTRUCTIONS

For Models: HD-5100



- STEP 1: Attach two (2) spindels to the base plate using two (2) of the short screws that are included with your Hold Down Kit.
- STEP 2: Locate where you want to mount the hold down and create the required mounting holes. Mount the base by using the two (2) long screws and the two (2) washers, and two (2) nuts, included.
- STEP 3: Attach the rubber bumpers to the bottom of the battery, one (1) in each corner, to support the ends of the battery.
- STEP 4: Center the battery on the Hold Down base and attach the top bracket with two (2) of the short screws included. Tighten the screws until the top bracket holds that battery firmly in place. **DO NOT OVERTIGHTEN OR DAMAGE TO YOUR BATTERY MAY OCCURE.**