

LOCK-RIGHT™ Performance Locker Installation Manual
Removable third member axles—one-piece case, 2-pinion differential
Typical of Toyota®, Nissan®, Isuzu® models

Introduction.....	2	Assembly Inspection.....	19
Background Information.....	3	Third Memeber Installation.....	20
Installations Covered.....	5	Vehicle Final Assembly.....	20
Preliminary Steps.....	5	Tire Diameters.....	20
Removal and Disassembly.....	5	Testing the Complete Installation.....	21
Differential Case Removal.....	6	Driving Your Vehicle.....	21
Disassembly of Differential Case.....	8	Subsequent Disassembly.....	22
Inspection of the Parts.....	8	Warranty Information.....	22
Preparing Parts for Assembly.....	10		
Assembly of Parts into Case.....	11		
Differential Case Completion.....	12		
Third Member Final Assembly.....	17		



WWW.RICHMONDGEAR.COM

Introduction

Welcome to the growing family of **LOCK-RIGHT** owners! This manual will help you install your new **LOCK-RIGHT** automatic 100% full-locking differential. When the installation is complete, your vehicle will have *extreme* traction! We trust that you will be pleased with its performance and thank you for your confidence in our products.

LOCK-RIGHT installation simply involves disassembling and re-assembling the differential case, replacing a few parts in the process. These instructions are detailed to the point that a person who is reasonably familiar with automotive work can install a **LOCK-RIGHT** into a third member in about three to four hours; please read them carefully before you start to be sure that you thoroughly understand them. Do not attempt shortcuts unless you know exactly what you are doing. These instructions also assume that you have the proper shop

manual for reference to instructions about axle removal, torque values, settings, clearances, etc. that apply to your particular vehicle. Our manual is a general guide to operations but does not contain specific information for each vehicle.

We suggest that your **first installation be done in the rear axle**. The weight of the engine over the **front axle** is **reduced** by weight transfer to the rear as your vehicle climbs a hill, meaning that more and more weight is being applied to the **rear axle**, where the locker is located, as more **traction** is needed.

Remember: This instruction manual is provided for your convenience to assist you or your mechanic with the installation of your new **LOCK-RIGHT**. However, the ultimate responsibility for the success of your installation and the subsequent proper operation of your vehicle rest with you, the vehicle owner.

When your installation is complete, you will have a vehicle with significantly increased capabilities. For continued “fun in the sun,” operate it in a safe and responsible manner. *Be sure to read and understand the driving information* in the **LOCK-RIGHT** Vehicle Owner’s Manual!

Background Information

The differential **case** is the round housing inside the rear axle assembly to which the ring gear is bolted and which contains the differential spider and side gear assembly. It is installed in the differential **carrier**, which is the housing that holds the case, drive pinion gear, bearings, etc. The carrier may be removable (as part of a “drop-out” unit, or third member), or it may be integral (as a permanent part of the axle assembly, mounted in the vehicle). This manual covers the removable third member, technically known as the Differential and Carrier Assembly.

The **LOCK-RIGHT** is designed to fit into **standard open differential cases only**, not into limited-slip (clutch-pack) type cases. If your vehicle contains a limited-slip unit you will need to purchase a standard open differential case, thrust washers and pinion shaft before proceeding.

A word about axle shaft thrust blocks: A few differentials use a thrust block between the inside ends of the axle shafts

as a part of the end play adjustment. When installing a **LOCK-RIGHT**, this block is **re-used** along with the original axles so that the original end play adjustment does not change. However, if the original axles are changed to different original-type axles, the block will continue to be used but the end play must be re-adjusted (see the shop manual for the procedure). If the axle is changed to another type that does not need end-play adjustment, such as a one-piece design, the thrust block may be omitted.

A word about side gear thrust washers: All differentials originally had a thrust washer under each side gear. Thrust washers are large in diameter and between about 1/32-inch (.031, or 0,76-mm) and 1/16-inch (.062, or 1,52-mm) thick. If either one or both are missing from the original differential, **obtain new one(s) before proceeding!** The **LOCK-RIGHT** is designed to be used with a correct thrust washer under **each** coupler, and failure to use this washer is easy to observe during inspection and will void the warranty.

NOTE: The parts shown in the various figures are typical and may not exactly depict your particular model.

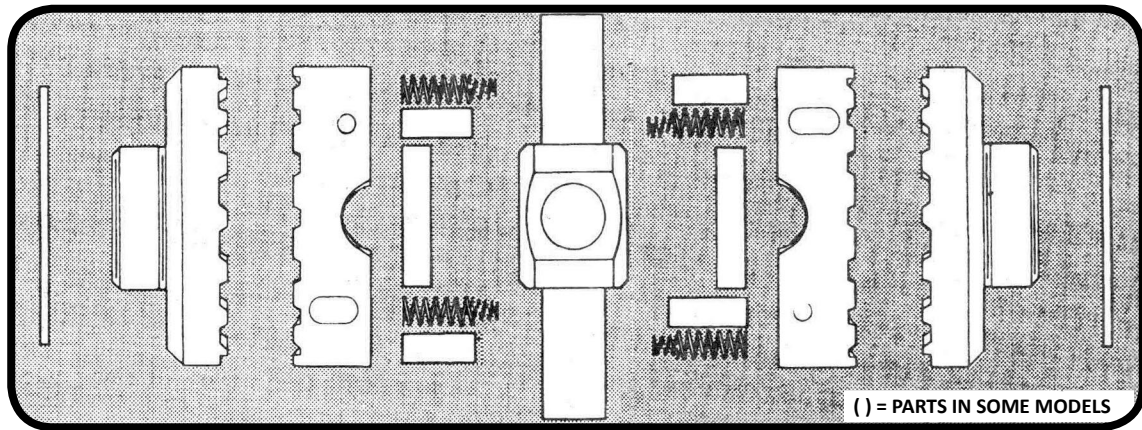

THRUST
WASHER

COUPLER
(SIDE GEAR)

DRIVER

STOP PIN;
SPACER

PINION
SHAFT(S)
(BLOCK)

BIAS
SRPINGS

DRIVER

COUPLER
(SIDE GEAR)

THRUST
WASHER

Figure 1
LOCK-RIGHT Exploded View

LOCK-RIGHT Installations Covered in This Manual

Removable third member axles. Typical of these are Toyota® 4-cylinder engine vehicles, both front and rear; similar applications in Nissan®, Isuzu®; certain domestic applications, etc.

Preliminary Steps

The following steps are only a general guide to preliminary operations used for preparing your vehicle for **LOCK-RIGHT** installation. For detailed information, refer to your shop manual. In general, the preliminary steps include:

- a) Blocking the vehicle**, putting transmission in neutral;
- b) Loosening the wheel lug nuts** (the removal may be optional; see shop manual);
- c) Jacking up the axle**; securely resting it on jack stands;
- d) Removing the tires** (some axles);

- e) Disconnecting the brake lines** and emergency brake cables (some axles);
- f) Pulling out one or both axles** a few inches.

Removal and Disassembly

Summary of steps in this section:

- a) Securely block and jack up vehicle
- b) Pull out axle shafts by about six inches
- c) Remove third member from vehicle
- d) Observe ring gear backlash
- e) Mark bearing caps and adjusters
- f) Remove differential case from carrier
- g) Mark bearing races
- h) Remove ring gear
- i) Remove internal parts
- j) Install **LOCK-RIGHT**

Removal of the Differential Case from the Carrier

1. Remove the third member from the vehicle as described in the shop manual. Follow all safety precautions.

2. Check to be sure that the third member is in good condition and that nothing is loose, worn or scored. Rock the ring gear back and forth to get a “feel” for the backlash and check to see that it appears to be set up properly. If any out-of-spec conditions exist, be sure to correct them before subsequent re-assembly.

NOTE: The third member itself can be disassembled and re-assembled without changing the ring and pinion settings *if you are careful*. Follow these steps in detail.

3. Mark everything! Don't touch a bolt until you have done so. The easiest tool to use is a **center punch**. We suggest placing the whole assembly upright (the same position as when in vehicle), looking at ring gear end. Mark carrier and bearing cap on the **ring gear side with one punch mark** and on the

other side with two marks (Figure 2). The caps are not interchangeable! Also mark each bearing adjuster directly under the lock hole with this same mark to note its side and rotational position. *This mark is very important to correct re-assembly!*

4. Remove the adjuster locks. (See **Figure 3**). Be sure that each adjuster is marked at the lock with the correct number of punch marks for each side. The adjusters are not interchangeable after they are marked for position! (In general, the adjuster locks themselves are interchangeable.)

5. Remove the bearing caps (Figure 3).

6. Slide (tap) the adjuster up and out and remove the bearing race on the ring gear side first and put a very small grind mark on the outside of the race to mark it. Scraping it on a cement floor also works, or you can use a tag. Be sure that you can identify it for proper re-assembly on the correct side!

7. Remove the differential case and ring gear assembly from the carrier along with the other adjuster and bearing race.



Figure 2
Mark carrier, caps, adjusters at lock hole

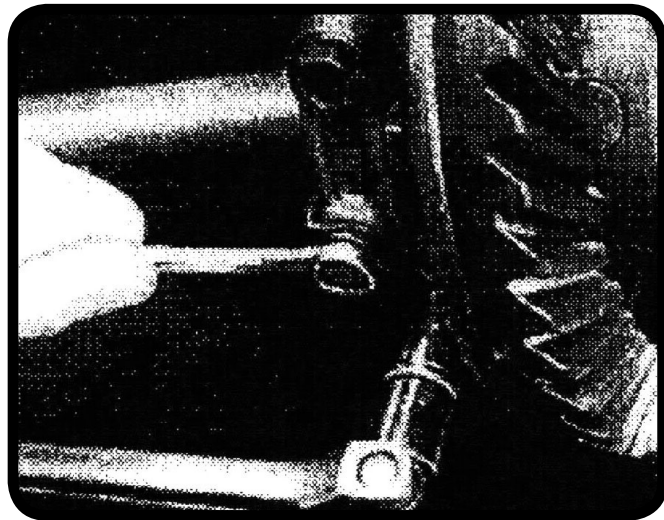

Figure 3
Remove adjusters lock and bearing caps

Disassembly of the Differential Case

1. Remove the ring gear if it interferes with the removal of the pinion shaft. It may need to be tapped off with a brass mallet. Mark it so that it can be re-installed in the same rotational orientation as when removed. **Note:** If the pinion shaft can be slid out past the ring gear teeth, the ring gear does not need to be removed.

2. Remove the pinion shaft retaining pin with a long punch or by unscrewing it as appropriate.

3. Remove the pinion shaft, spider gears, side gears, all washers, and the pinion shaft block (if used in your assembly).

Inspection of the Parts

NOTE: These steps are important. The **LOCK-RIGHT** utilizes your case, side gear thrust washers, pinion shaft and axle shaft thrust block, (if used), and they must be in excellent condition. The spider gears and washers are not used. If following inspection shows that anything is bad, buy new parts from your dealer!

1. Thoroughly clean the differential case and remaining parts with solvent, then dry them.

2. Inspect the pinion shaft. Any grooves or galling that can be felt may weaken it and can also adversely affect the operation of your new **LOCK-RIGHT**. If it is not in excellent condition, obtain a new one.

3. Inspect the side gear thrust washers. They are important to the correct positioning of the **LOCK-RIGHT** parts. If they are excessively worn or are cracked, obtain new ones. Several thicknesses may be offered; try to obtain the same size as the old ones. **NOTE:** There should be **TWO** thrust washers

of about equal thickness, one under each side gear.

4. Inspect the thrust block (if used). Be sure that the ends are smooth and not galled.

5. Inspect the case for any chips, cracks or similar damage. also inspect the bearings. If the case or bearings look bad, replace them. However, if you do, remember that the marked bearing adjuster positions no longer will be correct; the ring and pinion backlash and bearings pre-load will to be reset with a dial indicator as described in the shop manual.

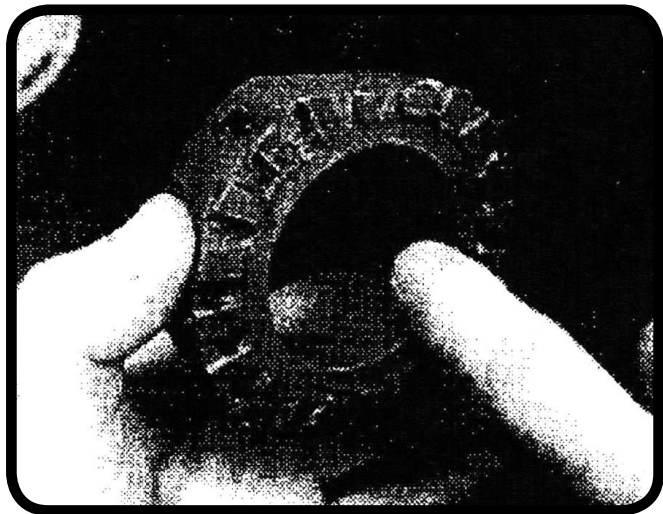

Figure 4
Grease driver teeth, inside surface; coupler teeth

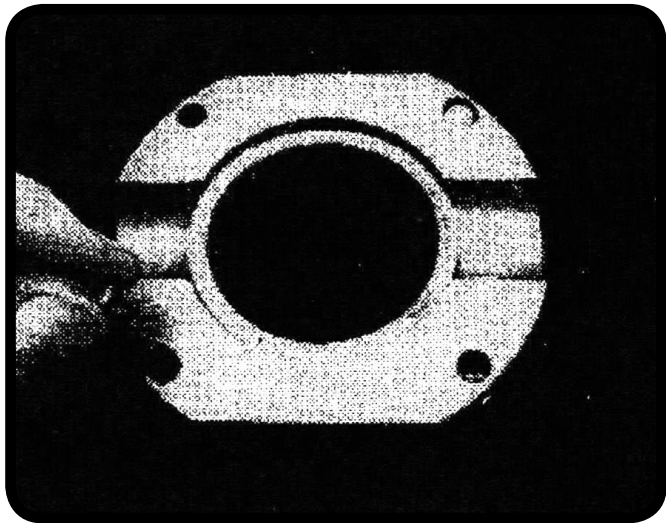

Figure 5
Install pins in window holes

LOCK-RIGHT Installation

Preparing the Parts for Assembly

1. Coat the teeth of the couplers and drivers, the large center holes of the drivers (**Figure 4**), and both sides of the thrust washers with medium grease. Also place a little grease in each of the two window holes in each driver. The grease will help hold things in place and assist with functioning until the gear oil circulates.

2. Place a shear pin into each window hole. It should be about flush (**Figure 5**).

3. Place a spacer into the center of each driver as seen in **Figure 5**, (wide end toward the teeth if the spacer is not symmetrical).

4. Press a thrust washer (with grease added) onto the back of each coupler (**Figure 6**).

5. Insert a small spring into each of the large springs and **add a little grease** to the coils to hold them together. Set them aside.

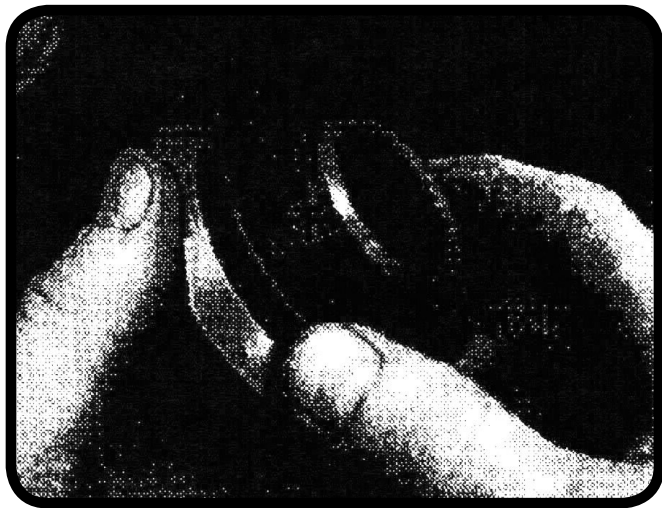

Figure 6
Install thrust washer on each coupler

Assembly of the LOCK-RIGHT Parts into the Differential Case

Summary of steps in this section:

- a) Install Ring gear side coupler and washer
- b) Install other coupler and washer
- c) Install left driver and spacer assembly
- d) Install other driver

1. Install a coupler and washer assembly in the ring gear end of the differential case. See **Figure 7**. Note that the couplers in some models may have flats for clearance.

2. Place the second coupler and washer assembly into the other end of the differential case (**Figure 7**).

3. Important! Be sure to have the spacers correctly oriented and placed in the drivers before doing the following steps!

4. Pick up a driver-and-spacer assembly. Orient its teeth toward the ring gear flange and hold it so that the flats (if present) will clear the sides of the case. Place it on the teeth of

5. Repeat this step for the other driver-and spacer assembly (Figure 8).

Differential Case Completion

Summary of steps in this section:

- a) Rotate drivers; align holes
- b) Push shear pin into other driver
- c) Install spring assembly
- d) Repeat for other pins and springs
- e) Push spacers outward
- f) Install pinion shaft and retaining pin.

1. Rotate the right driver until one of its long window holes (containing a pin faces out, and rotate the other driver until one of its empty pin holes lines up with the first window hole.

2. Push the pin out of the window hole and into the pin hole in the opposite driver with a small pointed tool (**Figure 9**).

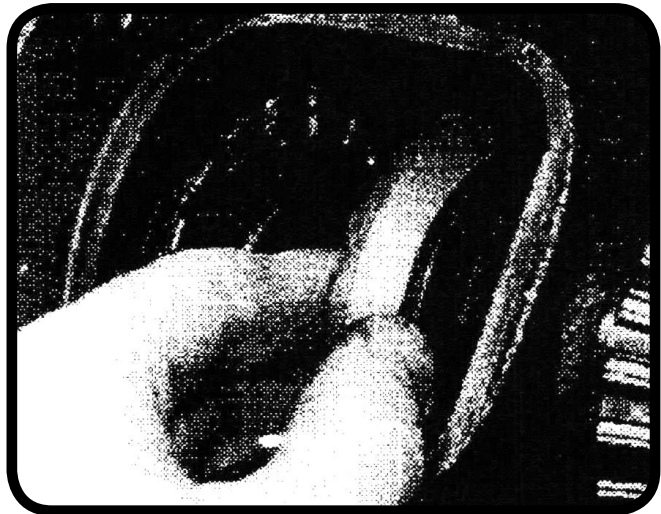

Figure 7
Install coupler/thrust washer assemblies

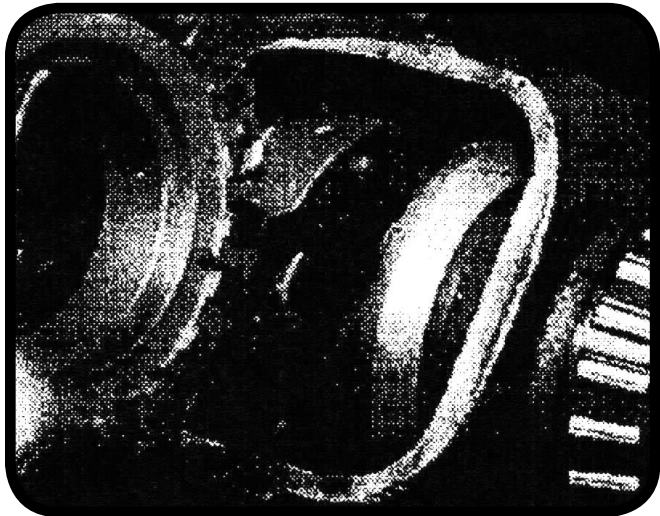

Figure 8
Install driver/spacer assemblies

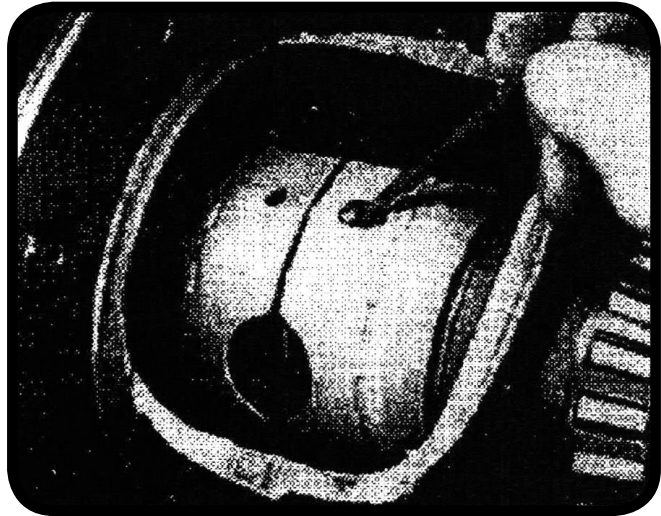

Figure 9
Push first pin into opposite driver

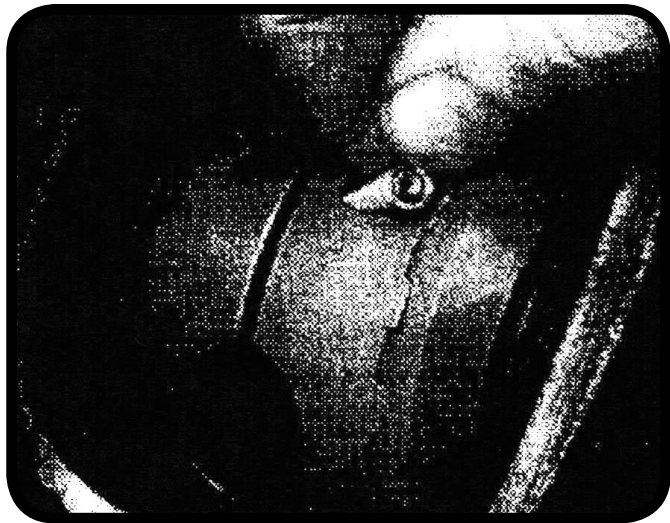

Figure 10
Install dual spring assembly

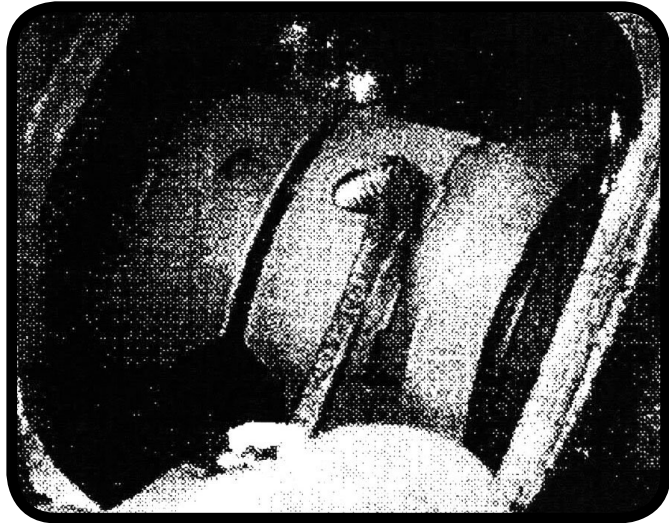

Figure 11
Compress spring assembly and push into hole

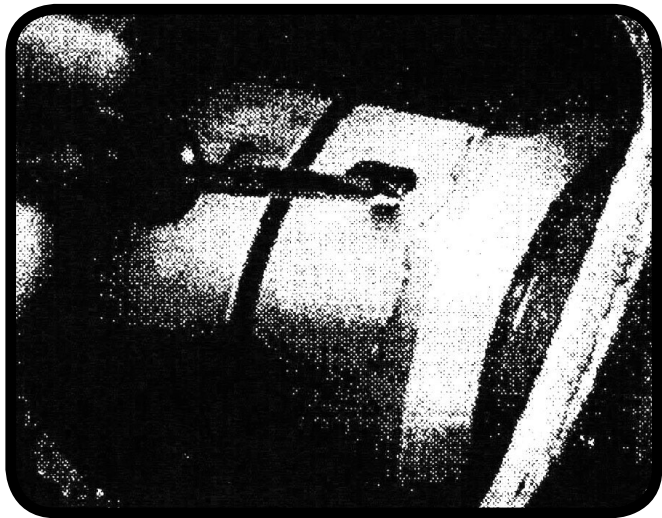

Figure 12

Seat end of spring assembly in hole bottom

3. Place one end of a spring assembly into the window hole, behind the pin (**Figure 10**). Compress it with a small screwdriver and pop the bottom into the window hold (**Figure 11**). Push on the bottom coils to be sure that the spring snaps in and is seated all the way (**Figure 12**). **Rotate the drivers** and do the same procedure for each of the other three pins and springs.

4. Reach in through the recesses with your fingers and be sure that the spacers are pushed outward, onto the couplers.

5. Rotate the drivers so that the large recesses line up with the pinion shaft holes in the differential case.

6. If an axle shaft thrust block is being used, push it into the center of the assembly through one of the couplers and line up the large hole with the pinion shaft holes.

7. Carefully insert the pinion shaft into the hole and guide it through the drivers, past the spacers (and through the thrust block if used). It should insert easily by hand. If not, tap it in, being very careful not to get the inner end caught on something!

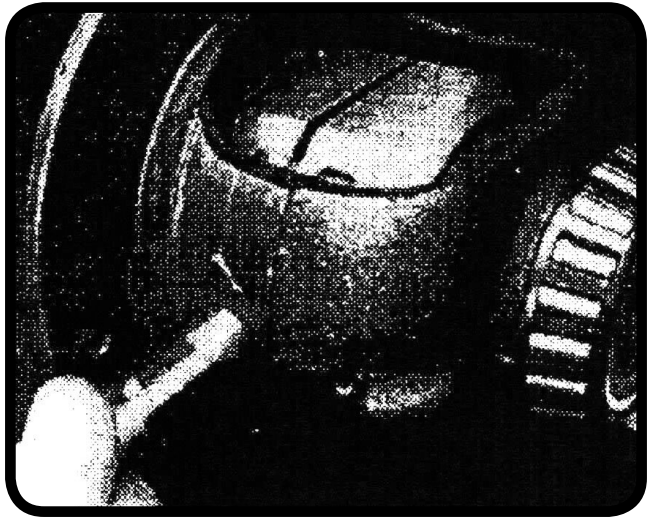

Figure 13
Install pinion shaft

Be sure to orient it so that its retaining pin hole will line up with the hole in the differential case (**Figure 13**). If the pinion shaft will not insert, or is hard to insert, be sure that the correct thrust washers are being used and that the spacers are oriented with the widest side (opening) fitting down over the coupler shoulder. Rotate the drivers and couplers back and forth to be sure that they are not binding.

8. Install the pinion shaft retaining pin. If the pin is solid, as opposed to a roll pin, slightly deform the metal on the side of the hole to help hold it in place (see shop manual).

9. Install the ring gear and torque the bolts.

10. Inspect your work. Look for anything that is not correct. Be sure that the drivers rotate back and forth smoothly, stopping at the pinion shaft. Use a light to see that the spacers (and thrust block, if used) are in place and that the springs are working properly.

Third Member Final Assembly

1. Position the carrier vertically, with the drive shaft flange pointing down. It can be held in a vise or even stood on its nose in a coffee can if a vise is not available.

2. Place the bearing races on the differential bearings. Be sure to place the marked one on the proper end.

3. Set the differential case (and bearing races) into the carrier. Install it with ring gear pushed all the way into the drive pinion—that is, with *no* backlash, and with the bearing races pushed *all the way* onto the bearings.

4. Check the punch marks on the adjusters and determine which one goes on the side nearest the ring gear. Hold it so that the mark is at its final position (where the lock will be installed, pointing away from the carrier). Push the adjuster against the race and slide it down into the threads in the carrier. They should mesh easily, with no space between the parts.

5. Install the correctly-marked cap. Use the bolts as guides by turning them in two threads or so and then sliding the

cap down to meet the case. Be sure that the cap threads fit into those in the adjuster. Do not force anything. The cap should slide down very close to the carrier surface. Tighten the bolts until they are snug (see **Figure 14**).

6. Hold the other adjuster so that the mark is in the same relative position as the other one (with the mark away from the carrier) and slide it down the bearing race into the threads. As it meshes, it should shift outward a little and be positioned slightly away from the race (adjuster shown in **Figure 15**).

7. Install the other cap. Again, use the bolts as guides by turning them in two threads or so and then sliding the cap down to meet the case. Turn the bolts until they are barely snug. Be sure that the cap threads fit into those in the adjuster. Do not force anything.

8. Use a spanner wrench or a blunt punch and a hammer to turn the second adjuster (the one away from the ring gear) one turn inward (clockwise) until the marked hole reaches its final position (in the middle of the cap just below the lock).

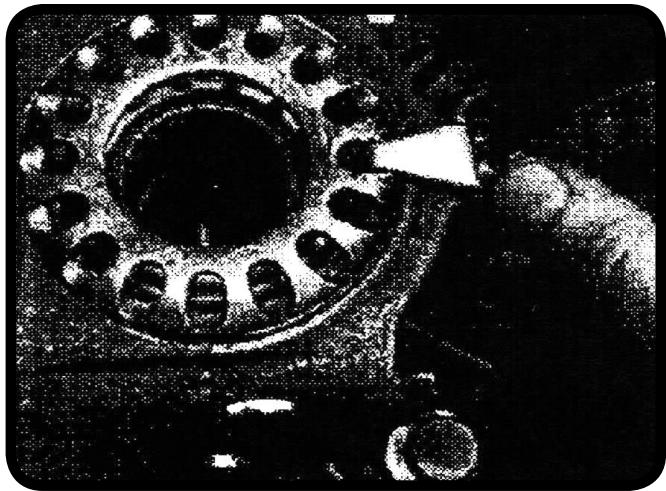

Figure 14
Re-install cap and adjuster at marked position

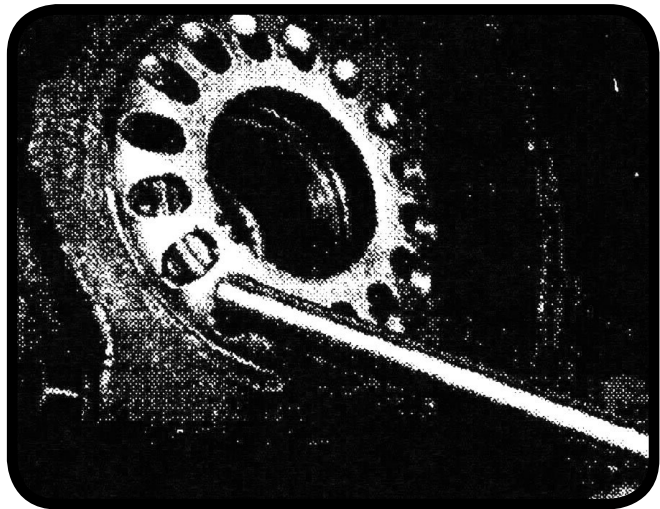

Figure 15
Turn other adjuster to final position; install locks

The last portion of the turn should be difficult because pre-load is being applied to the bearings by spreading the caps apart as the adjuster is being turned in.

9. Insert an axle shaft or bar into one of the axle shaft holes in the differential case to help with holding the assembly or place it in a large vise, and torque the cap bolts to their correct value (see shop manual).

10. Install the adjuster locks and torque the bolts. Be sure that they are located in the marked holes (as shown in **Figure 14**).

11. As an additional check to be sure that everything has been installed correctly, use a small ruler, vernier caliper or blade-type feeler gauge. The distance between the halves of the **LOCK-RIGHT**, that is, between the two drivers, should be about 5/32-inch (.152-inch, or 3,86-mm). The tolerance limits are between .145-inch (3,68-mm) and .170-inch (4,32-mm). If this distance is much over .170-inch, either the case is quite worn or the thrust washers are missing or are too thin and the problem should be corrected before proceeding further.

Assembly Inspection

1. Inspect your work. Look for anything that is not correct. Be sure that the drivers rotate back and forth smoothly, stopping at the pinion shaft. Use a light to see that the spacers (and thrust block, if used) are in place and that the springs are working properly.

When the above installation steps are completed, all the parts should be in exactly the same positions as they were when the installation began. The backlash and pre-load settings should be unchanged from before and no further adjustments will be needed. To be certain, rock the ring gear back and forth to see if the backlash appears to be the same as it was prior to the installation. If not, it will need to be reset with a dial indicator as described in the shop manual. Rotate the ring gear one revolution to be sure that nothing is binding.

Third Member Installation

1. **Clean the mating surface** of the axle housing and the mounting surface of the differential carrier.
2. **Clean the inside of the axle housing** to remove all foreign material. This step is very important because metal chips can interfere with the operation of your new **LOCK-RIGHT**.
3. **Remove metal chips** from the drain plug if it is magnetic.
4. **Install a gasket** and/or sealant as appropriate.
5. **Lift the third member** into the axle housing and shove it into the studs.
6. **Install and torque** the hardware.
7. **Re-install the axle shafts** and finish the remaining vehicle re-assembly steps.

Vehicle Final Assembly

Add gear oil. Note that we suggest using medium-to-heavy oils as recommended by the manufacturer, unless the vehicle will be used in very cold weather. Thicker oil, such

as 85-140, reduces the “clicking” noise sometimes heard during tight turns and provides adequate lubrication when the assembly becomes hot. Also see the section in the Vehicle Operator’s Manual regarding temperature.

Your **LOCK-RIGHT** installation should now be complete. As a preliminary test, rotate the tires back and forth (transmission out of gear and driveshaft free). The drivers should randomly unlock and “click” as the tires move. Note that the tires will NOT lock together—this easy-unlocking characteristic is a unique feature of the **LOCK-RIGHT** and is perfectly normal.

Tire Diameters

To help assure a long life for your new **LOCK-RIGHT**, **tire diameters should be as nearly equal as possible**. **DO NOT** change the inflation pressure to vary the rolling radius of the tire! This practice can be dangerous if one of the tires is under-inflated, producing excess heat, faster tire wear and more difficult vehicle control. The best way to equalize the rotation is to measure

the circumference of all the tires, including the spare. Choose ones that are within about 3/8-inch or less of each other (do not change from side-to-side if they are radials). If one tire is much more worn than the other one, they both should be replaced for safety reasons.

Testing Your Installation

1. Be sure that the vehicle is safely blocked. Leave the axle assembly on the jack stands, with both tires free to rotate and the emergency brake off.

2. Put the transmission and transfer case in gear to lock the drive shaft.

3. Rotate one of the tires in the forward direction with your hand until it stops, then hold it. That side of the **LOCK-RIGHT** is now locked.

4. Rotate the other tire in the opposite (reverse) direction. The **LOCK-RIGHT** should “click” as the coupler attached to the axle rotates.

5. Rotate the first tire in the reverse direction and hold it; repeat step 3, rotating the other tire in the forward direction.

6. Repeat steps 2-4, rotating and holding the second tire to lock the second side.

Driving Your Vehicle

If the foregoing measurements and tests have been successfully completed, apply the emergency brake and remove the vehicle from the jack stands. Your vehicle should now be ready to drive.

*Carefully read and understand the driving information contained in the **LOCK-RIGHT** Vehicle Owner's Manual! Safe and effective use of your new **LOCK-RIGHT**-equipped vehicle depends on knowledgeable operation, and this can only be done by understanding its characteristics before you start. Be careful, and have fun!*

Subsequent Disassembly

If something is not correct now or if you need to disassemble your **LOCK-RIGHT** in the future, we will briefly describe the procedure here. We will assume that the case has a thin ring gear and remains in the vehicle, or that it has a thick ring gear and has been removed from the vehicle and is on the bench.

1. Remove the pinion shaft retaining pin and then the pinion shaft.

2. Rotate the drivers until one of the window holes faces out. Push under the spring with a small sharp-pointed pick and pry the end up. Push a small screwdriver or bent piece of small wire (a paper clip works well) under the spring and pop the bottom out. Push the shear pin out of the pin hole and into the window hole from which the spring was removed. Repeat for the other three springs and pins.

3. Position the case horizontally and push in the spacers so the middle of the drivers. If a thrust block is used, push it out through either coupler.

4. Remove the driver and spacer opposite the ring gear flange first and then remove the second driver.

5. Remove the couplers.

Warranty Information

The Warranty is contained in the Vehicle Owner's Manual that is supplied with your new **LOCK-RIGHT**. Consult this manual for complete warranty information.

IMPORTANT

If your differential case or thrust washers are excessively worn, your new **LOCK-RIGHT** Locker may not be able to operate as it was designed. Therefore, two easy measurements must be made before final assembly to assure that your new locker will function properly. To make these measurements, proceed as follows:

1. Remove the existing spider gears, side gears and thrust washers from the differential case, and thoroughly clean it.
2. Install the **LOCK-RIGHT** couplers with the existing thrust washers in each end of the case.
3. Place the spacers onto the centers of the couplers (wide side toward the axle splines if not symmetrical), and hold them there.
4. Install the pinion shaft; carefully guide it past the spacers as it is being inserted through the holes in the case.
5. Measure the gap between each spacer and the pinion shaft with a feeler gauge. This gap should be between .005-inch and .020-inch, with not more than an .008-inch difference between the two.

If your numbers are within the limits specified, remove the parts and begin your installation. If your numbers are not within these limits, check the thrust washers and the differential case. If they are excessively worn or are damaged, they may need to be replaced before installing your new Lock-Right Locker.

If you have any questions, call PowerTrax Customer Service at 1.864.843.9275 (8AM-6PM ET) for further assistance.

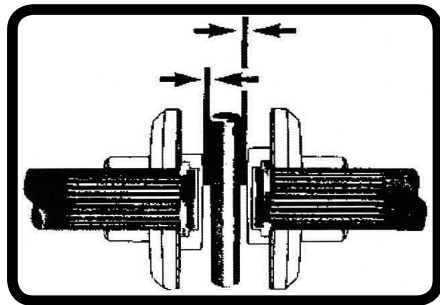

WARNING!

The following [WARNING] and [CAUTION] information is supplied to you for your protection and to provide you with many years of trouble free and safe operation of your Richmond Gear product.

Read **ALL** instructions prior to operating transmission and/or ring and pinion. Injury to personnel, transmission or ring and pinion failure may be caused by improper installation, maintenance or operation.

DANGER!

•It is **dangerous to get under a jacked-up vehicle**. The vehicle could slip off the jack and fall on you. You could be crushed. Never place any part of your body under a vehicle that is on a jack. Never start or run the engine while the vehicle is on a jack. **If you need to get under a raised vehicle, take it to a service center where it can be raised on a lift.**

WARNING!

•Hot oil can cause severe burns. Use extreme care when removing lubrication plugs and when working close to a unit that has been in operation.

IMPORTANT INFORMATION Please Read Carefully

CAUTION!

- Check lube level between scheduled lube changes to insure that proper lube level is maintained. Inspect vent plug to insure it is clean and operating. Inspect the tightness of mounting bolts, misalignment of connecting shafts, lube leakage, excessive heating, or any unusual noise or vibration.
- Serious personal injury may occur as a result of improperly performed maintenance, adjustments or repairs.
- Do not attempt any of the maintenance, checks or repairs described on the following pages if you are not fully familiar with these or other procedures with respect to the transmission, or are uncertain as to how to proceed. Have the necessary work done by a properly equipped and qualified workshop.
- Always be extremely careful when working on the transmission. Always follow commonly accepted safety practices and general common sense. Never risk personal injury.

(continued on next page)

CAUTION!

- Do not operate the transmission or ring and pinion without proper lube and correct amount.
- For safe operation and to maintain the unit warranty, when changing a factory installed fastener for any reason, it becomes the responsibility of the person making the change to properly account for fastener grade, thread engagement, load, tightening torque and the means of torque retention.
- Mounting bolts should be periodically checked to ensure that the unit is firmly anchored for proper operation.
- These instructions are not intended to cover all details or variations in equipment, nor provide for every possible contingency to be met in connection with selection, installation, operation, and maintenance. Should further information be desired or should particular problems arise which are not covered sufficiently for the Buyer's purpose, the matter should be referred to Richmond Gear.

In the event of the resale of any of the goods, in whatever form, Resellers/Buyers will include the following language in a conspicuous place and in a conspicuous manner in a written agreement covering such sale:

The manufacturer makes no warranties or representations, express or implied, by operation of law or otherwise, as to the merchantability or fitness for a particular purpose of the goods sold hereunder. Buyer acknowledges that it alone has determined that the goods purchased hereunder will suitably meet the requirements of their intended use. In no event will the manufacturer be liable for consequential, incidental or other damages. Even if the repair or replacement remedy shall be deemed to have failed of its essential purpose under Section 2-719 of the Uniform Commercial code, the manufacturer shall have no liability to Buyer for consequential damages.

Resellers/Buyers agree to also include this entire document including the danger, warnings and cautions above in a conspicuous place and in a conspicuous manner in writing to instruct users on the safe usage of the product.

This information should be read together with all other printed information supplied by Richmond Gear.

NOTES:

NOTES:

