

PAINLESS

PERFORMANCE PRODUCTS

Track Rocker Installation Instructions



For Installing Painless Part Numbers:

**58102: 8-Switch Customizable Track Rocker Switch Panel
w/ 1 5/8" & 1 3/4" Roll Bar Straps**

**58105: 6-Switch Customizable Track Rocker Switch Panel
w/ 1 5/8" & 1 3/4" Roll Bar Straps**

**58108: 4-Switch Customizable Track Rocker Switch Panel
w/ 1 5/8" & 1 3/4" Roll Bar Straps**

Manual 90639

Painless Performance Products recommends you, the installer, read this installation manual from front to back before installing this harness.

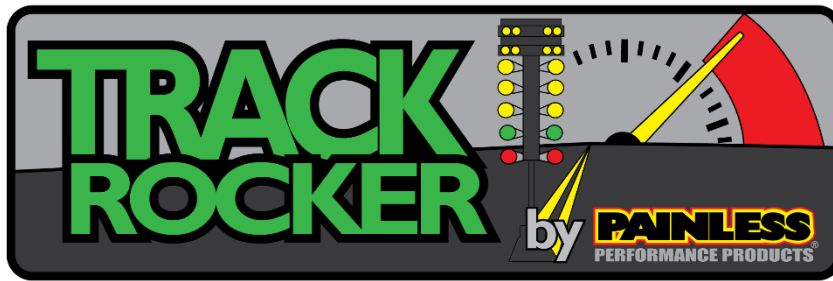

Painless Performance Products, LLC

2501 Ludelle Street

Fort Worth, TX 76105-1036

800-423-9696 phone – 817-244-4024 fax

Web Site: www.painlessperformance.com

E-Mail: painless@painlessperformance.com

If you have any questions concerning the installation of this product, feel free to call **Painless Performance Products'** tech line at 1-800-423-9696. Calls are answered from 8 am to 5 pm central time, Monday thru Thursday, 8am-4:30 pm Friday, except holidays.

Here we have provided you with accurate instructions for the installation of this product. However, if you have comments/suggestions concerning these instructions, please call or email us (our contact information can be found at the top of this page or online at www.painlessperformance.com). We sincerely appreciate your business.

Painless Performance Products, LLC shall in no event be liable in contract or tort (including negligence) for special, indirect, incidental, or consequential damages, such as but not limited to, loss of property, or any other damages, costs or expenses which might be claimed as the result of the use or failure of the goods sold hereby, except only the cost of repair or replacement.

Should you damage or lose part of your manual, a full-color copy of these instructions can be found online at www.painlessperformance.com

Installation Manual: **90639**

1st Edition: August 2018

Copyright © 2018 by Perfect Performance Products, LLC

TABLE OF CONTENTS

<u>PAGE #</u>	<u>SECTION</u>
1	<u>CONTENTS OF THE PAINLESS KIT</u>
2	<u>TOOLS NEEDED</u>
3	<u>INSTALLING FACTORY STYLE TERMINALS</u>
4	<u>SWITCH PANEL INSTALLATION</u>
9	<u>CONNECTING TO THE TRACK ROCKER FUSE/RELAY CENTER</u> <u>(PAINLESS #58100)</u>
13	<u>SWITCH WIRING</u>
15	<u>DOUBLING SWITCH CONTROL WIRES</u>
16	<u>ECM CONNECTION</u>
19	<u>PAINLESS PERFORMANCE LIMITED WARRANTY AND RETURN</u> <u>POLICY</u>

CONTENTS OF THE PAINLESS KIT

Refer to the **Contents Figure** (below) to take inventory. See that you have everything you're intended to have in this kit. If you find that anything is missing or damaged, please contact the dealer where you obtained the kit or Painless Performance at (800) 423-9696.

The Painless Track Rocker Kit should contain the following:

- 4, 6, or 8-Switch Customizable Track Rocker Switch Panel.
- Powder-coated Switch Panel Box
- Roll Bar Straps: (2) 1 5/8" & (2) 1 3/4"
- Parts Kit
- This manual: 90639



SMALL PARTS

Painless harnesses include parts kits that contain the terminals, fuses, screws, and nuts necessary for a professional installation. Many of the terminals are non-insulated and will require heat shrink to be applied after the terminal has been properly crimped. Waterproof heat shrink has been supplied. These non-insulated terminals allow you to make clean, weatherproof connections that look like a factory installed wiring system. When crimping these terminals, take special notice of the split in each terminal. Make sure the smooth side of the jaw on the crimper goes towards this split.



TOOLS NEEDED

This installation primarily requires only basic hand tools that may include, but are not limited to:

1. Wire cutter / “dikes”
2. **Wire Crimping and Stripping Tools:**

Another style of crimpers is “Roll-Over Crimpers.” These crimpers will crimp factory style, non-insulated terminals. Painless offers “Roll-Over Crimpers,” such as those seen to the right, under Painless part #70900.

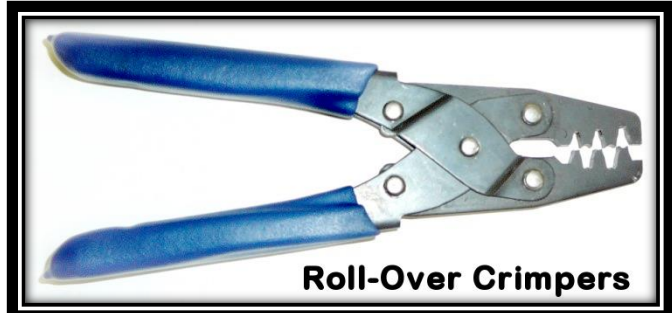

A good set of wire strippers is required to strip wire properly. This style of wire stripper is ideal for this harness install because of its ability to properly strip wire gauges 10 thru 20. These are available from just about any local auto part store, electrical supply shop, home improvement store or can be purchased online.



3. **Volt/Ohm Meter:**

A Volt/Ohm meter is always a good tool to have on hand when installing any type of electrical component in a vehicle. The most basic meters provide the two functions required to diagnose electrical issues commonly seen during a harness install: voltage measurement and continuity testing. Voltage measurement is the ability to read DC voltage. Continuity testing allows you to test



INSTALLING FACTORY STYLE TERMINALS

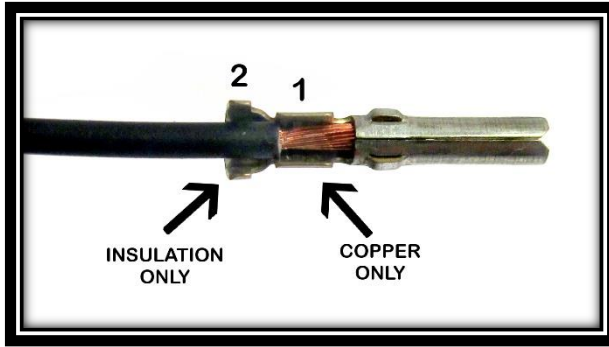

In the parts kit, you will see uninsulated female terminals. These terminals are for the **10-pin connector shell** included in the **Track Rocker Fuse/Relay Center** parts kit, and require roll over crimpers.

- Strip about $\frac{3}{16}$ " of insulation off of the wire.



- Insert the wire into the terminal. There are two terminal straps on the terminal. For instructional purposes, we will label them 1 and 2. Strap 1 crimps the exposed copper strands of the wire, while strap 2 crimps the wire insulation. Make your strip length long enough to ensure only copper strands are crimped by Strap 1 but short enough that only insulation is crimped by Strap 2. The photo to the left best demonstrates this.



- Using the appropriate jaw on the crimpers, crimp Strap 1. The appropriate jaw depends on the wire gauge as well as the terminal stiffness. If you are unsure which jaw to use, you can always start with the biggest and work your way down until you get a tight crimp.

- With Strap 1 crimped, move onto crimping the insulation strap: Strap 2. Place Strap 2 into the appropriate jaw of the crimpers. This jaw will be larger than the one used to crimp the first strap. Crimp down on Strap 2 making sure the strap folds down into the wire, and not overlapping itself. Refer to the drawing to the left. Overlapping could cause problems with the terminal fitting into the factory connector.

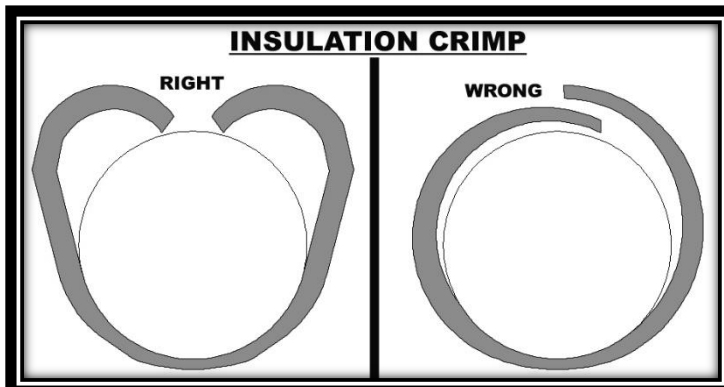

SWITCH PANEL INSTALLATION

Step 1: First, prepare the **Switch Panel** for mounting into the **Switch Panel Box**.

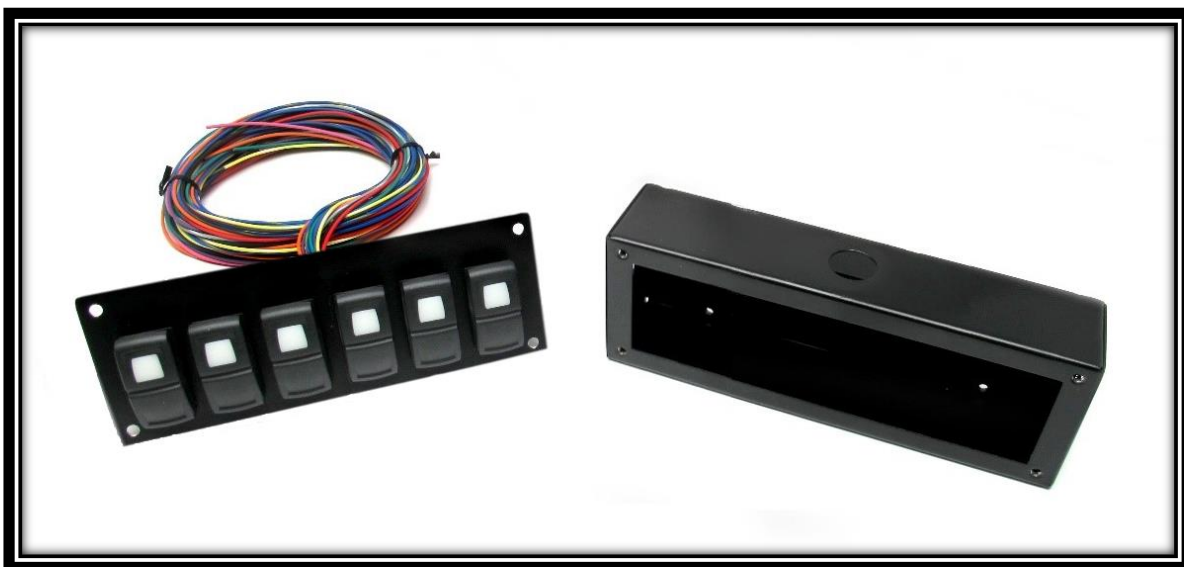

Step 2: Now, decide which direction you want to run the **Switch Panel Wires**. The **Switch Panel Box** has 3 holes through which to route the wires.

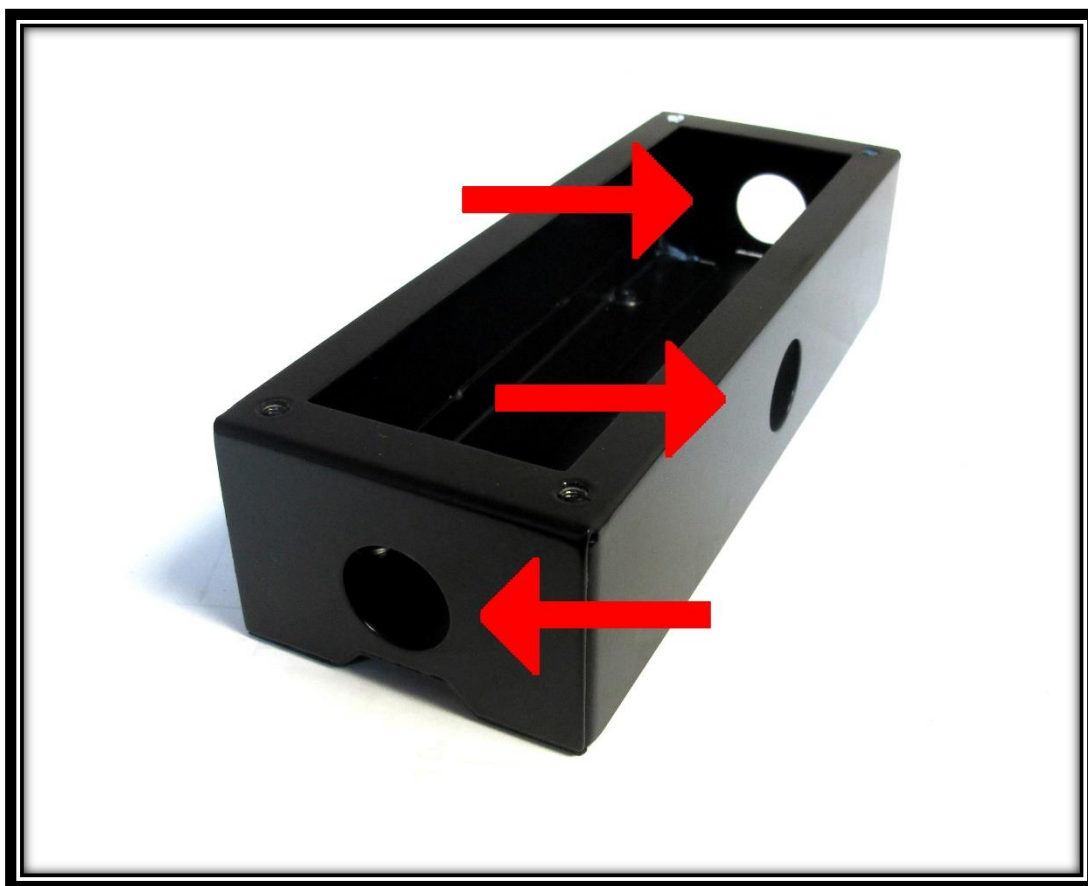

Step 3: Run the Switch Panel Wires through one of the 3 openings and then through the rubber grommet found in the parts kit.

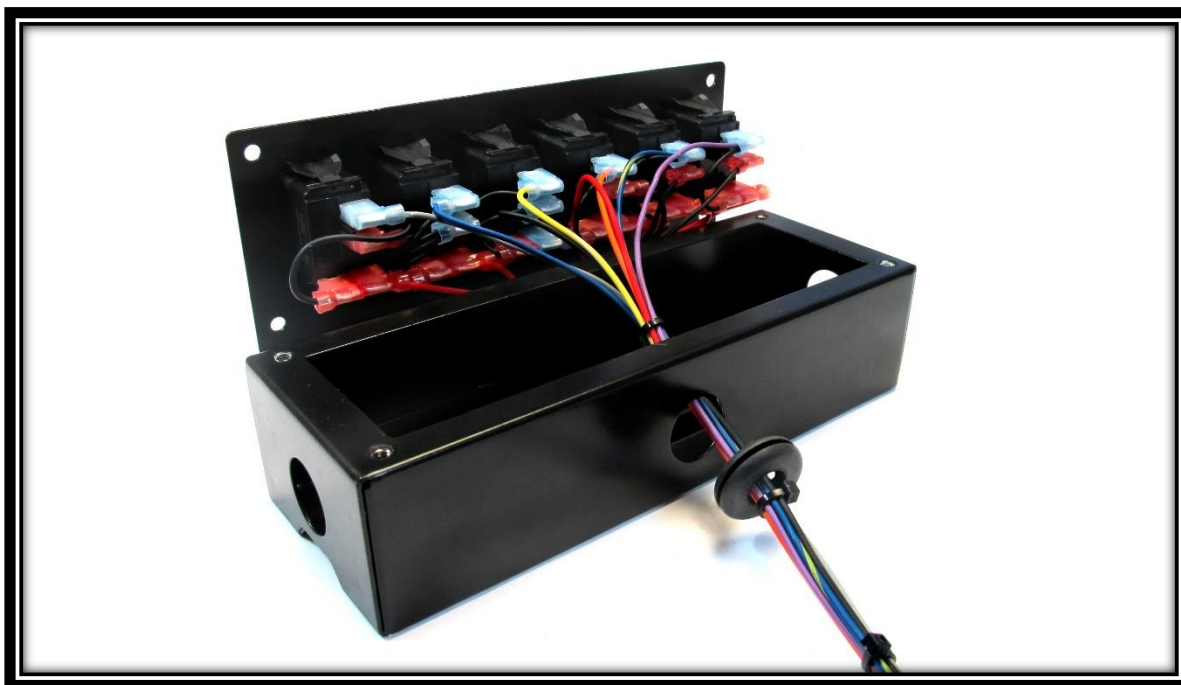

Step 4: If you wish to loom the Switch Panel Wires, do so now. We recommend [Painless ½" PowerBraid \(P/N: 70902\)](#). Run the loom over the wire, through the grommet, and into the box. You can secure the end of the loom with a zip-tie. **Note: It isn't necessary to loom the entire wiring harness as you will cut these wires to length later. Simply loom a few feet and make sure the end inside the base is secure.**

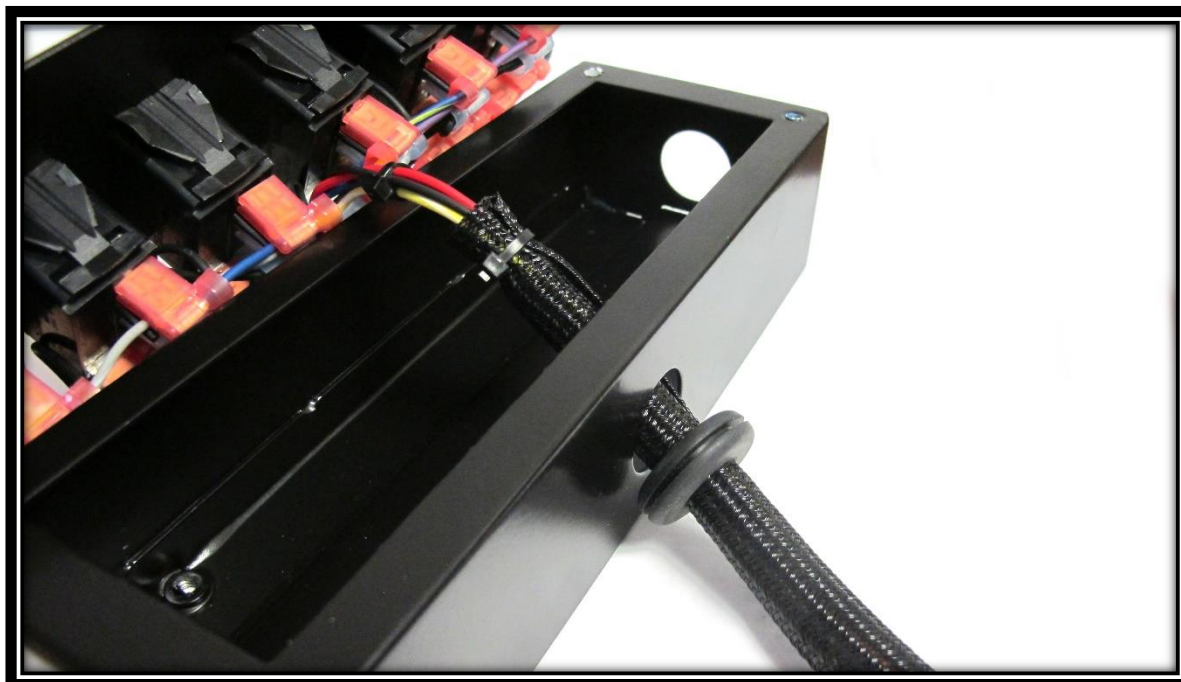

Step 5: Place the rubber grommet into the opening. Then, use the **(2) plastic plugs** provided in the parts kit, to close up the remaining holes.

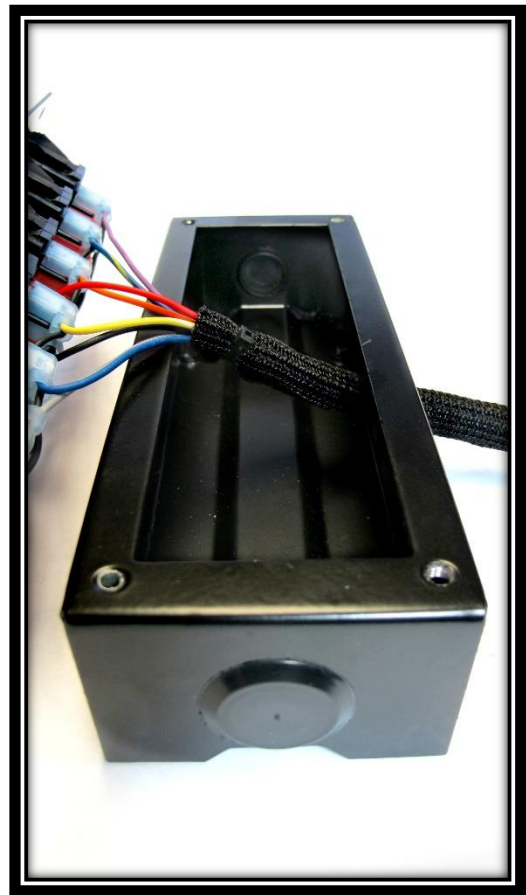
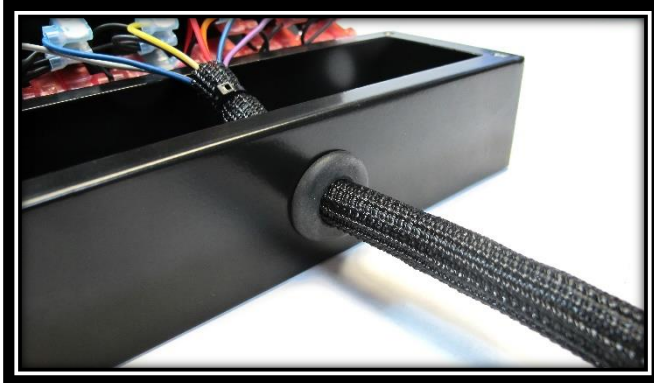

Step 6: Make sure the **Switch Panel Box** is properly covering the back of the **Switch Panel**, and use **(4) 10 – 32 x 3/8” button head screws** and the **small hex key** provided in the parts kit to secure the panel to the box. Remember to start each screw into the threads and tighten evenly.



Step 7: Once you've selected where you'd like to mount your **Track Rocker Switch Panel**, select the correct size **Roll Bar Strap** for your roll bar: $1\frac{5}{8}$ " or $1\frac{3}{4}$ ".

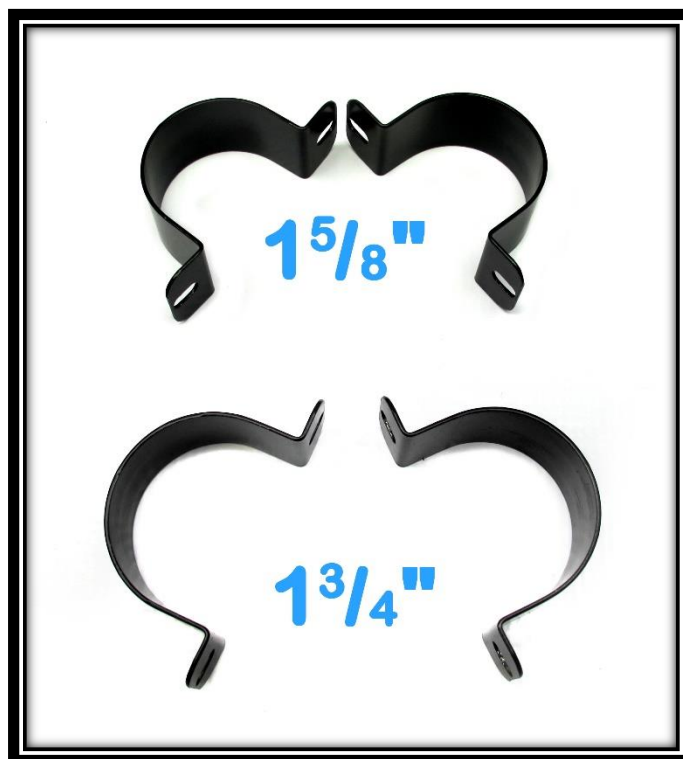

Step 8: Locate the 4 holes on the back of the Switch Panel Box. This is where you'll mount the **Roll Bar Straps** to the **Switch Panel Box**.

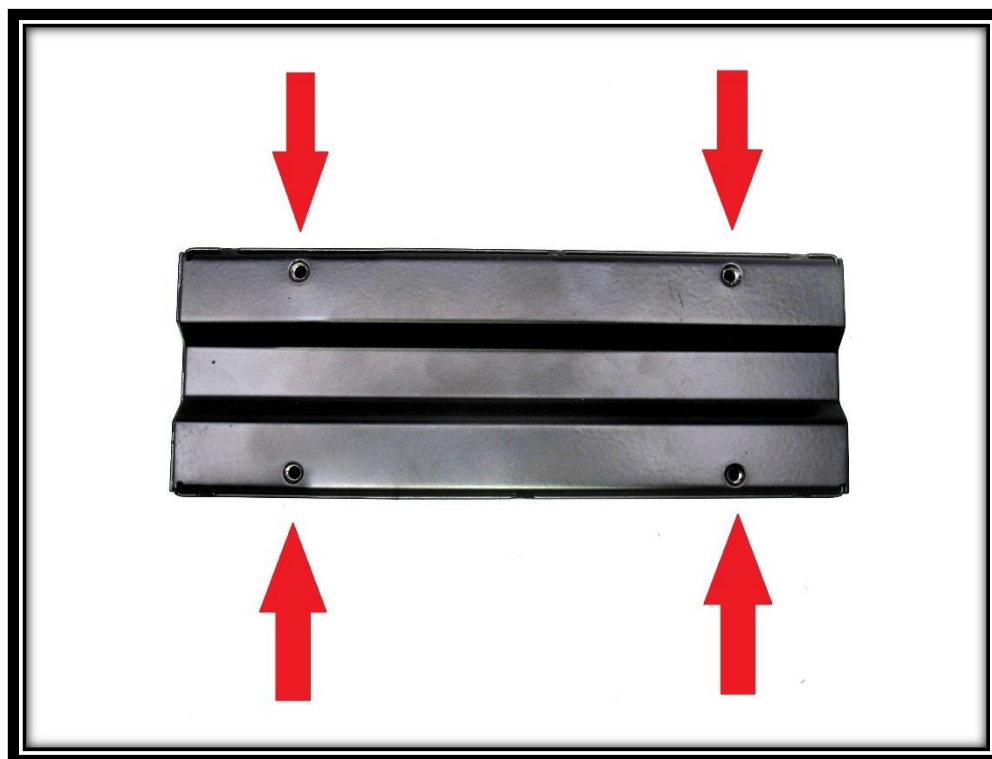

Step 9: Then, select **(4) #10 lock washers**, **(4) #10 flat washers**, and **(4) 10 – 32 x 3/8” button head screws** and the **small hex key** provided in order to mount the **Switch Panel**.



Step 10: Once, you’ve selected a spot to mount your **Track Rocker Switch Panel**, use the hardware to mount the switch panel.



CONNECTING TO THE TRACK ROCKER FUSE/RELAY CENTER (PAINLESS #58100)

Step 11: Route the Switch Panel Wires to the Switch Control Wires coming from your Track Rocker Fuse/Relay Center (**Painless #58100**). A **10-pin, male connector housing** was provided in the Fuse/ Relay Center's parts kit. **Terminals** are provided in the parts kit in order to install the wires in this connector.



Step 12: It may help to familiarize yourself with the wiring diagram below before installing the wires from the Switch Panel into the **10-pin connector housing** in Step 16.

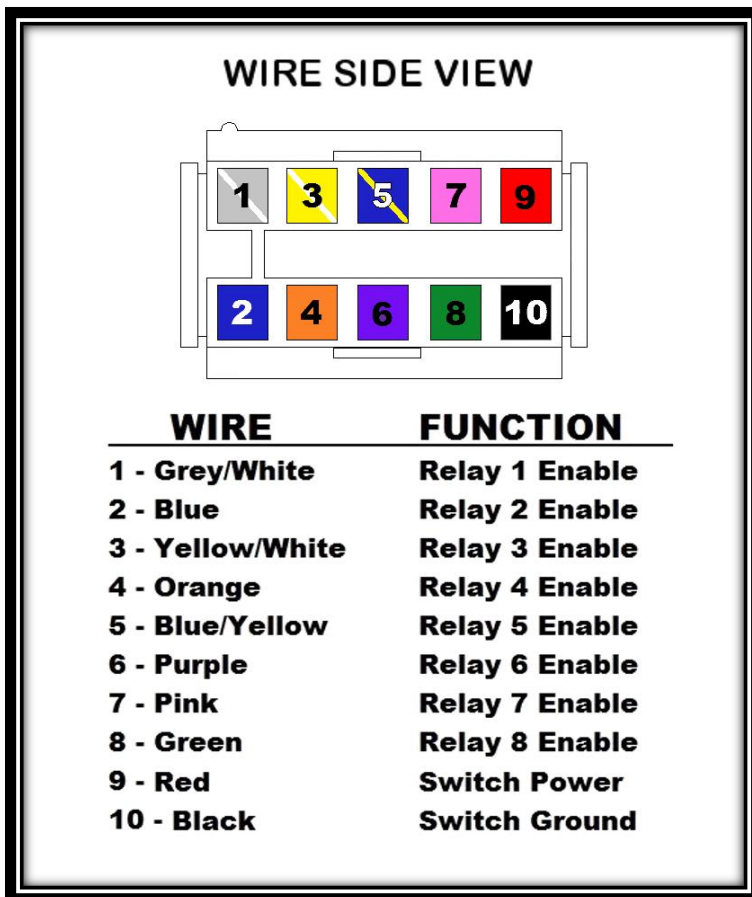

Step 13: After routing the **Switch Panel Wires** to the **Fuse/Relay Center's Switch Control Wires**, cut the **Switch Panel Wires** and loom (if used) to length. Secure the end of the loom with a zip-tie (provided) or a large piece of heat-shrink (not provided).

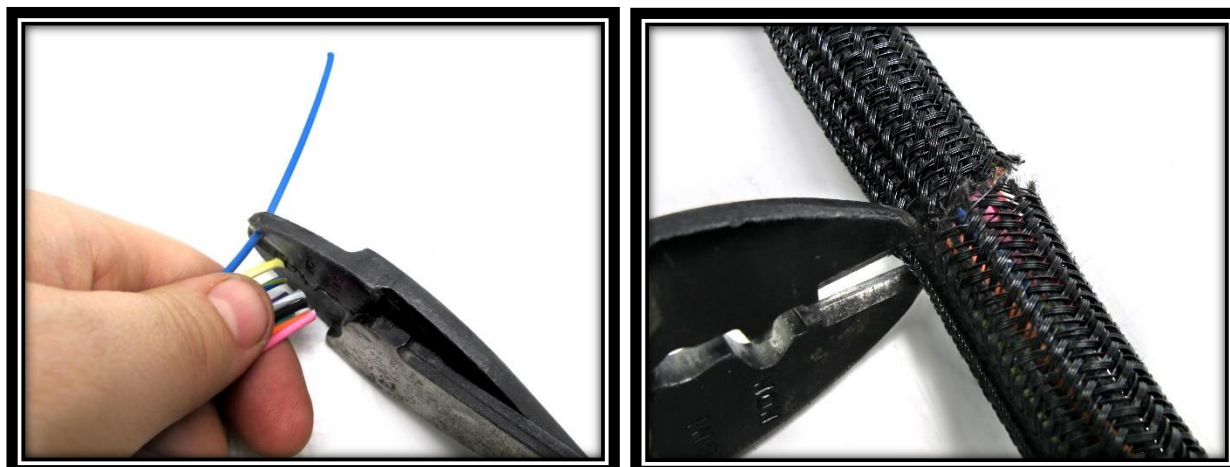

Step 14: Strip each of the **Switch Panel Wires** $\frac{3}{16}$ " , and install a female pin terminal from the parts kit onto the end of each wire. See [page 3](#) for detailed instructions on how to properly crimp these terminals. We recommend [Painless #70900 Roll-Over Crimpers](#).

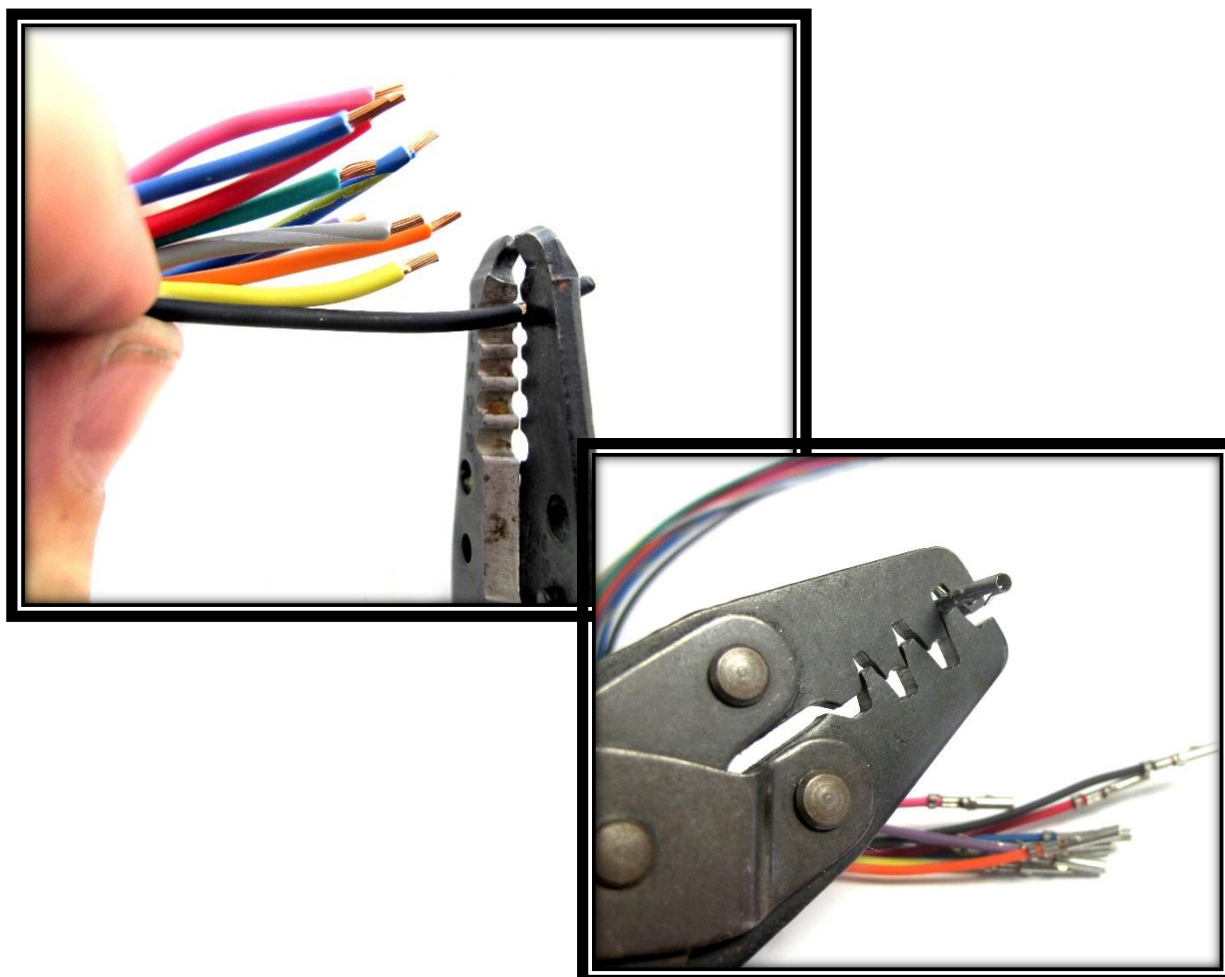

Step 15: Locate the **10-pin connector housing** included in the Fuse/Relay Center's parts kit. Note the locating tab for orientation.

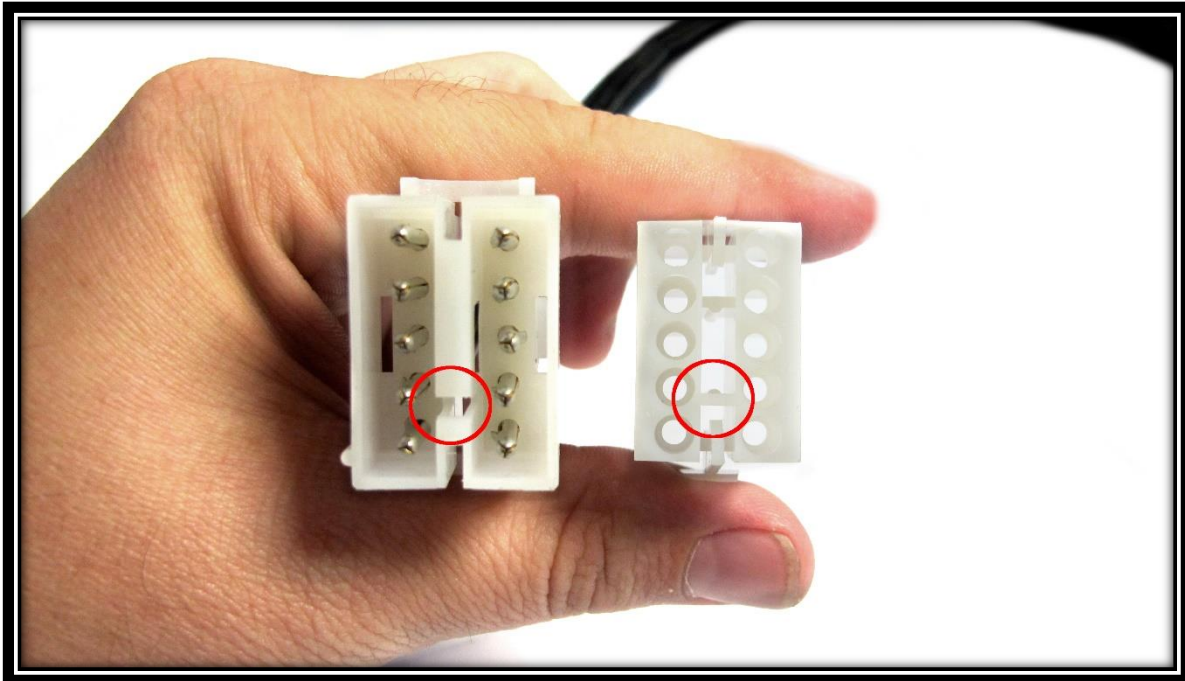

Step 16: Insert the newly pinned wires into the **10-pin connector housing**. **Make sure, while inserting the pins, that once connected the wire color matches the one across from it.** The diagram on **page 9** illustrates the pinout of the **10-pin connector housing** from the wire side.

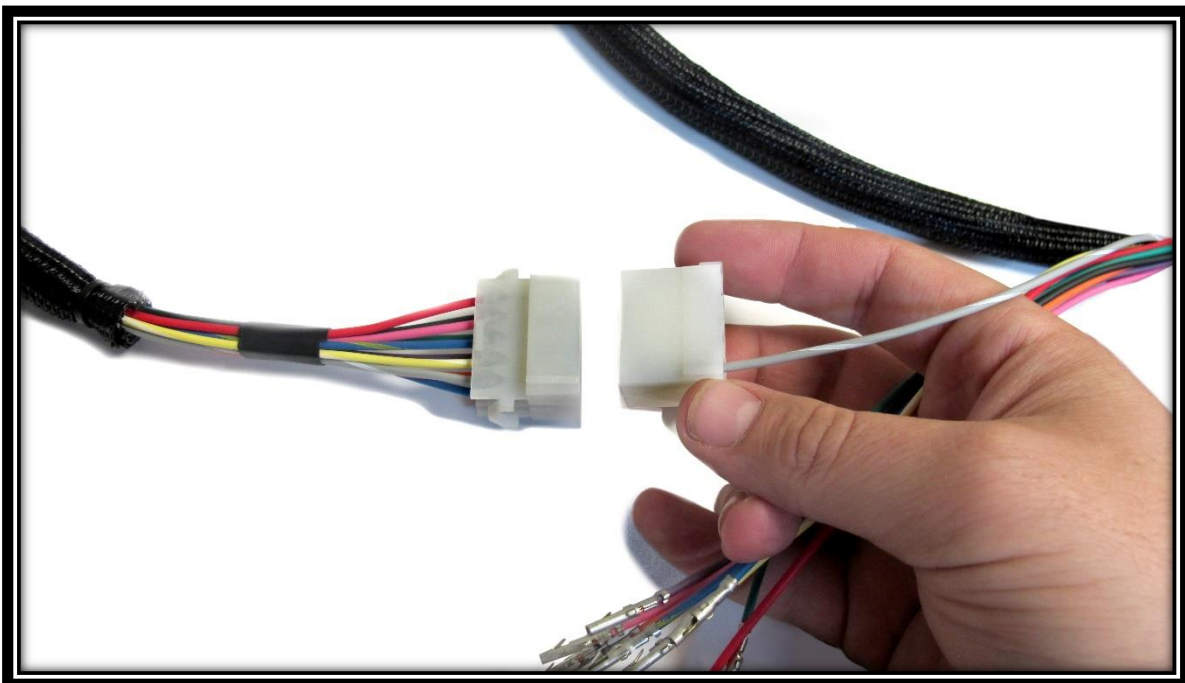



Step 17: Once completed, the connector should appear as it does to the left & below.

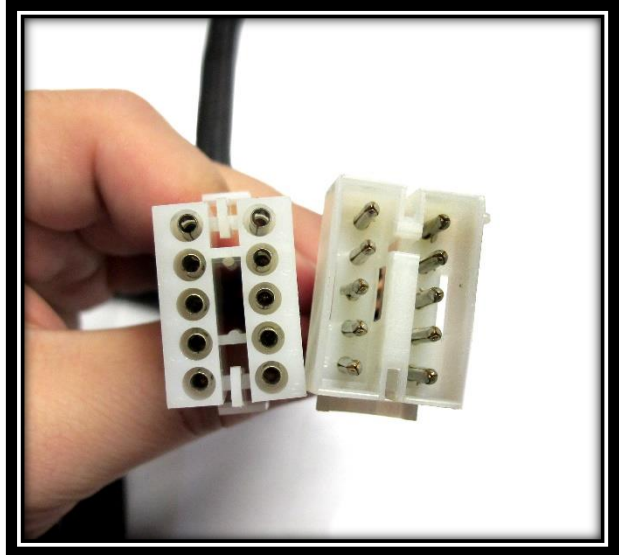

Step 18: Link the two connectors and join the wiring harness from the Fuse/Relay Center to the Switch Panel. Use [zip-ties](#) to secure the wires up under the dash and out of the way.

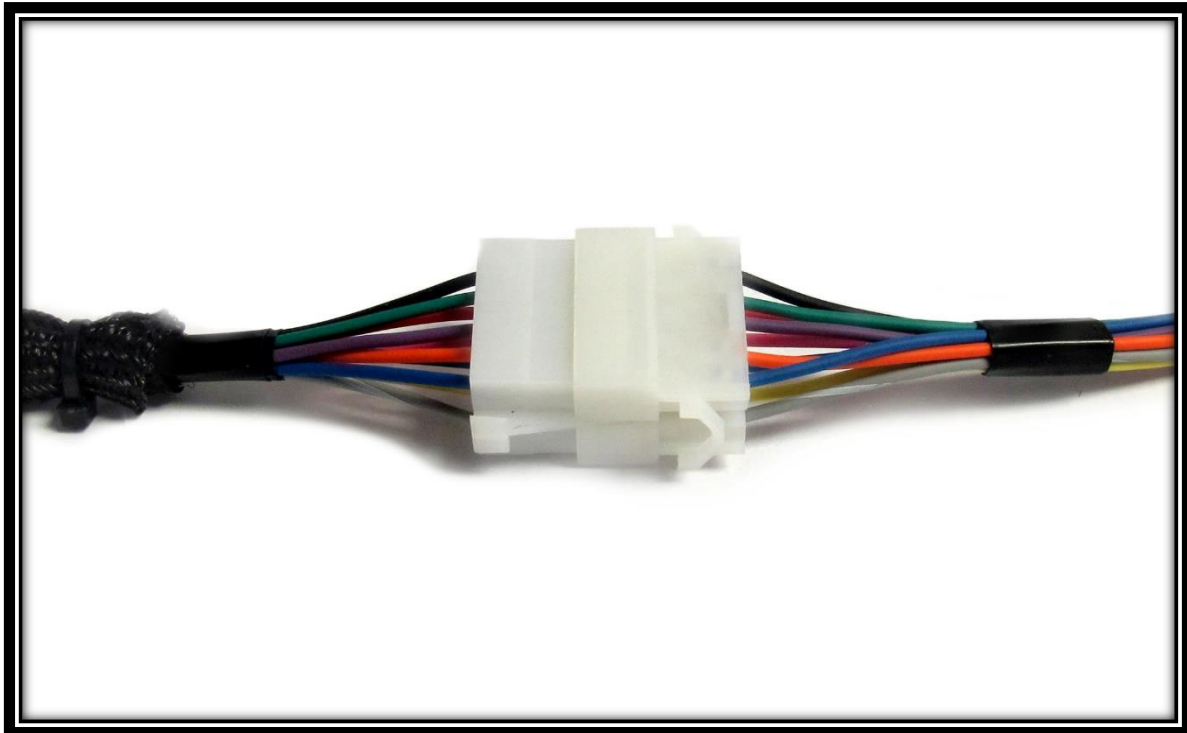

SWITCH WIRING

The lighted rocker switches included in your kit are wired as shown in the diagram below.

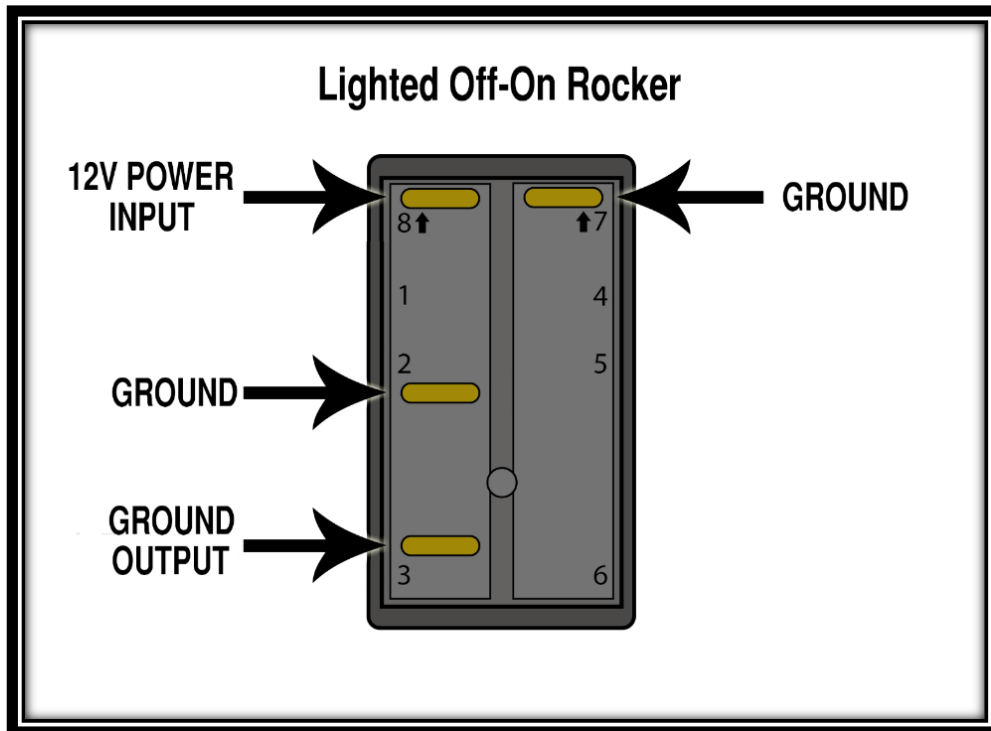

This kit also contains an optional Momentary-On Switch for various applications such as a starter, nitrous purge, or fuel pump prime.

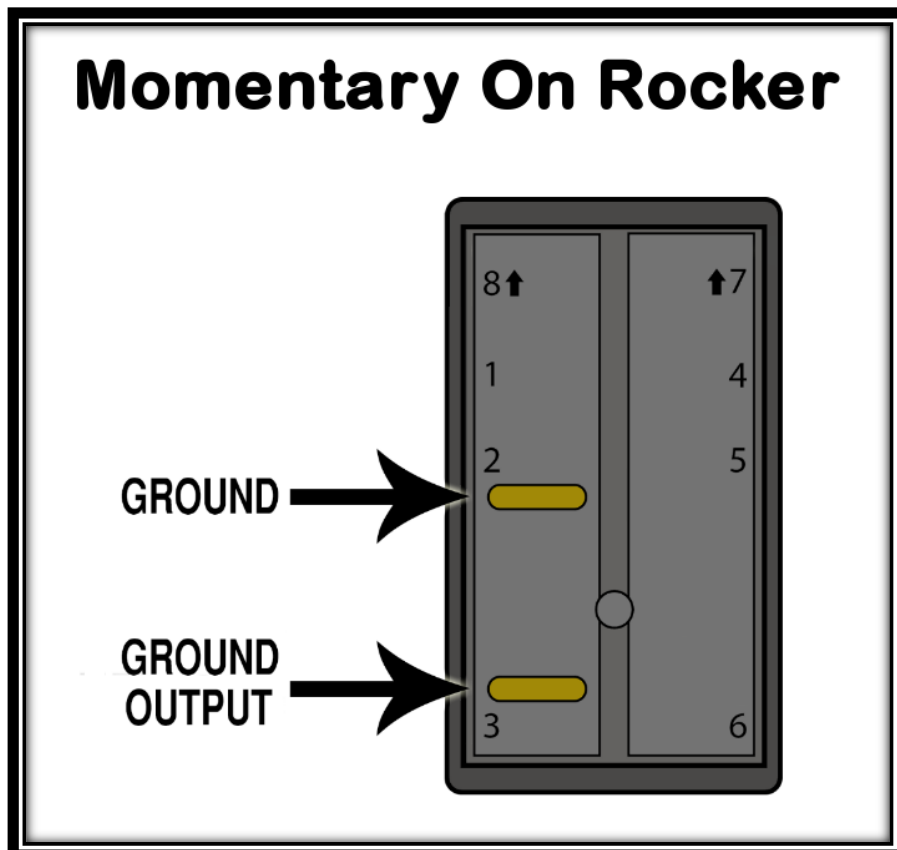

Step 19: To replace a switch with the **Momentary On Switch**, remove the **power, output, and ground wires** from the switch you are replacing. Then, locate the tabs located at the top and bottom of the switch.

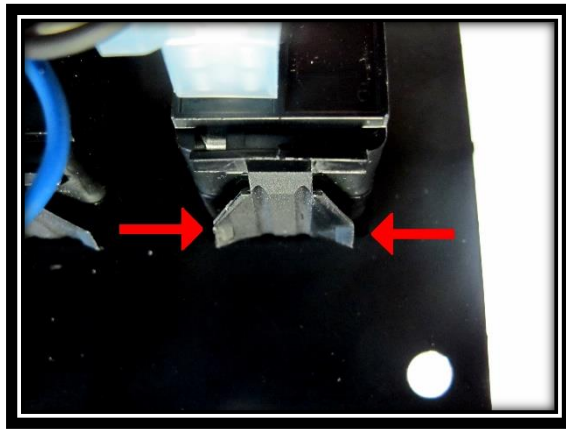

Step 20: These tabs lock the switch in place. To remove the switch, squeeze the tabs in and slide it out of the bracket.

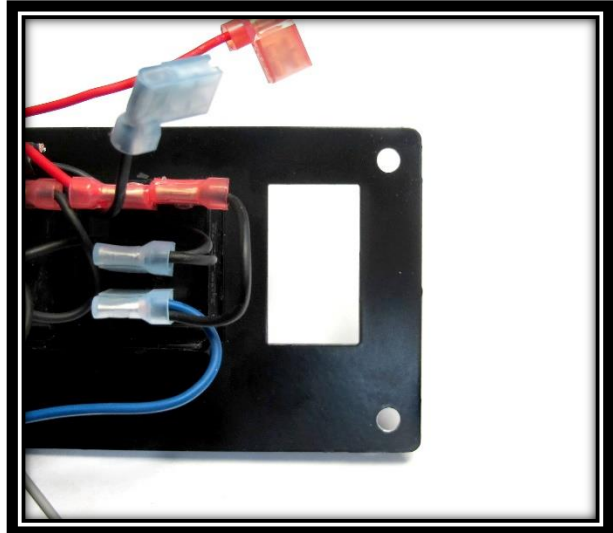
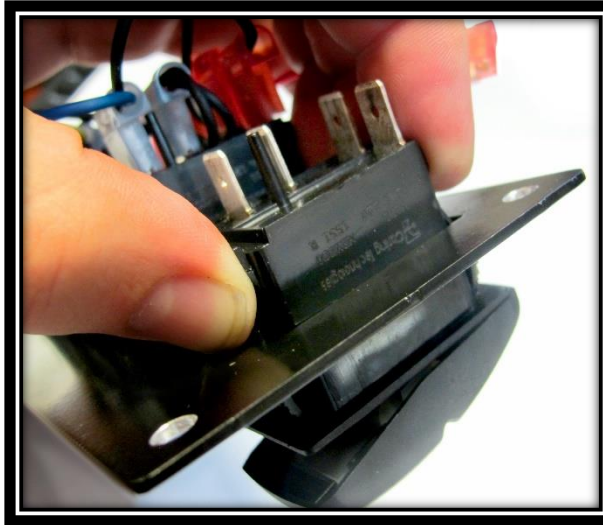

Step 21: Insert the **Momentary On Switch** into the empty socket of the bracket. Then, connect the ground and output wires. The red wire will not be needed and can be stowed out of the way.

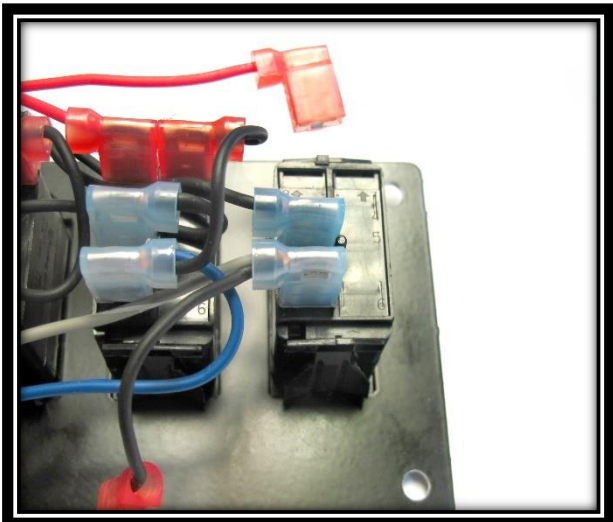
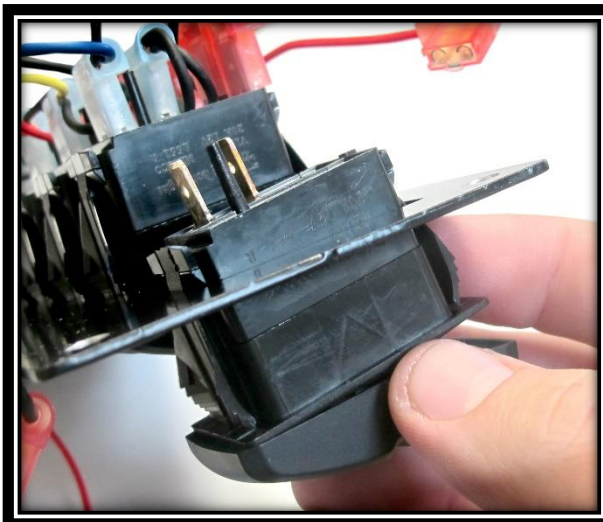

DOUBLING SWITCH CONTROL WIRES

The Trail Rocker Fuse/Relay Center is capable of supporting 8 different accessories. Those with 4 & 6 Switch Panels may wish to control multiple accessories with a single switch in order to utilize all 8 relays. Steps 22 & 23 are optional and only for those who wish to control multiple functions for one switch.

Step 22: Normally we recommend doubling the switches at the Ground Output terminal. However, the back of the Trail Rocker Switch Panel is already heavily populated and adding a third wire to this connection may be cumbersome for some.

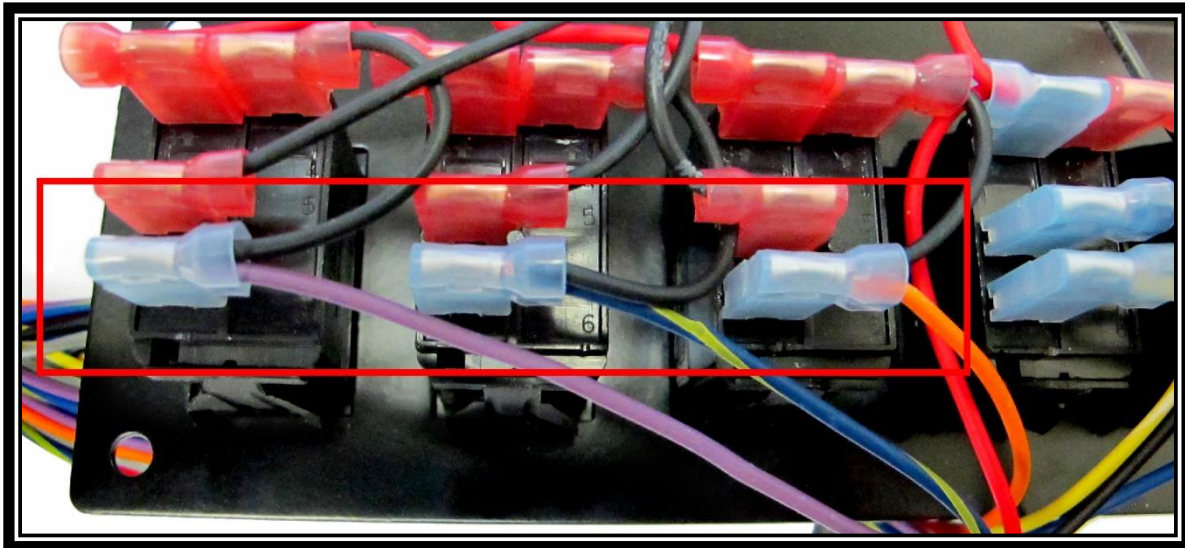

Step 23: Therefore, we recommend splicing an additional switch control wire into the switch before the terminal.

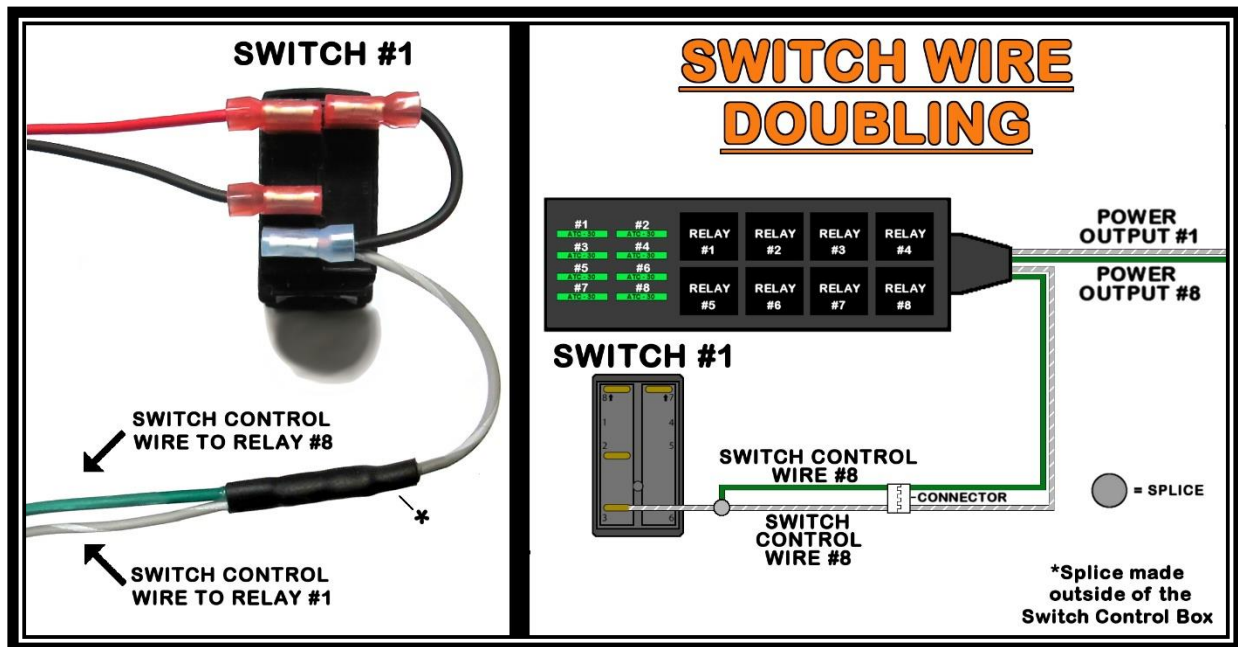

ECM CONNECTION

In some race applications, you may want to have components controlled with either a toggle or rocker switch AND an aftermarket ECM (Engine Control Module). If this is the case, the **Track Rocker** is designed to allow **BOTH** a grounding switch and an aftermarket ECM to ground the 85(-) terminal on the coil inside of the relay. This is commonly referred to as “sinking the relay to ground.” All the relays in the **Track Rocker** are ‘diode suppressed,’ therefore; it is **CRITICAL** the 85(-) terminal is **ONLY** used as ground control.

This redundancy allows you to manually operate components, like the cooling fans, while still allowing them to function automatically as programmed into a microcontroller. Most aftermarket ECM’s can be tied into the **Track Rocker System**. To do so simply splice the appropriate grounding output wire(s) from the ECM into the **Switch Control Pigtail** wires.

Doing this allows either the switch or the ECM to complete the circuit within the relay and activate the relay’s output wire. This will also illuminate the lighted switches to illuminate whether the component was activated manually by the switch or automatically by the computer, thus signaling the driver anytime the component is active.

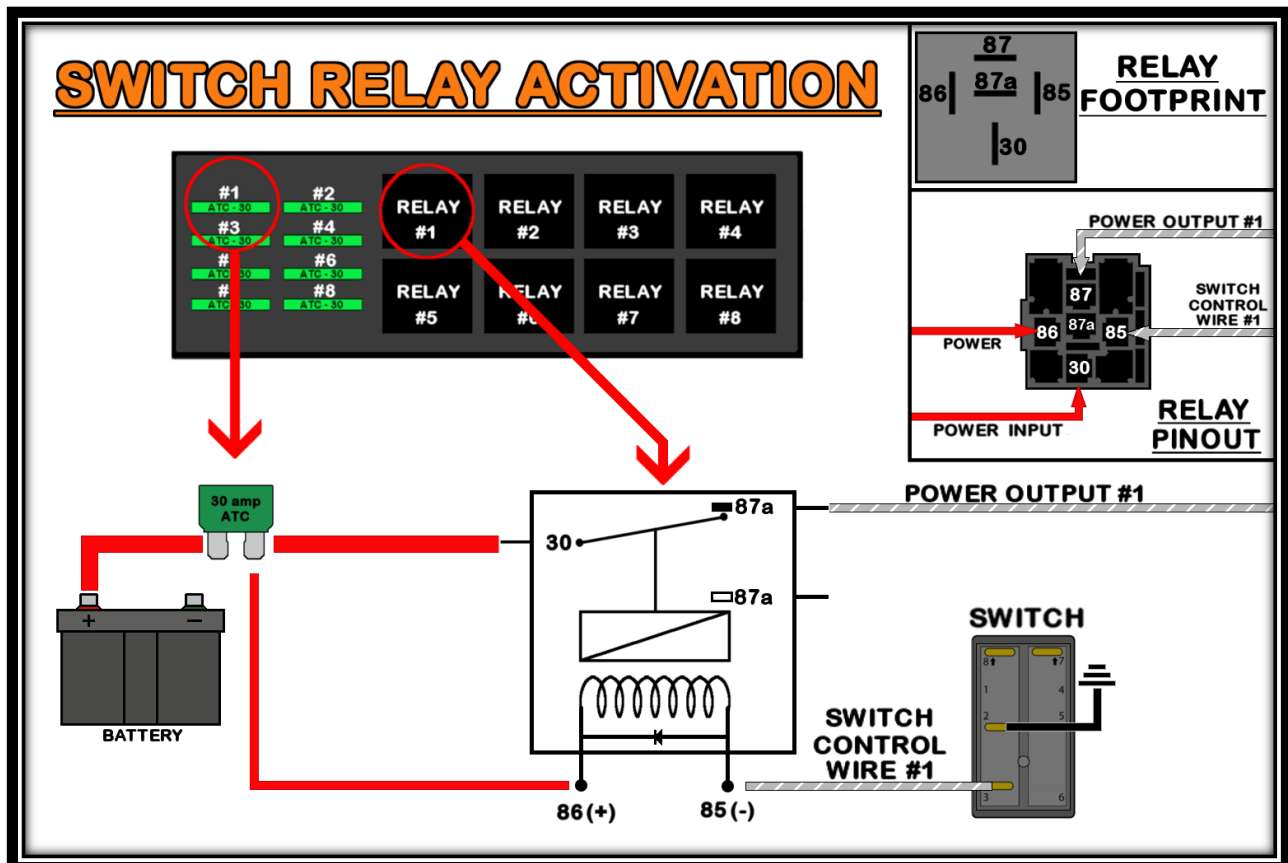

Step 24: Refer to your ECM's wiring diagram and locate the appropriate output for the component you wish to tie into the Track Rocker System.

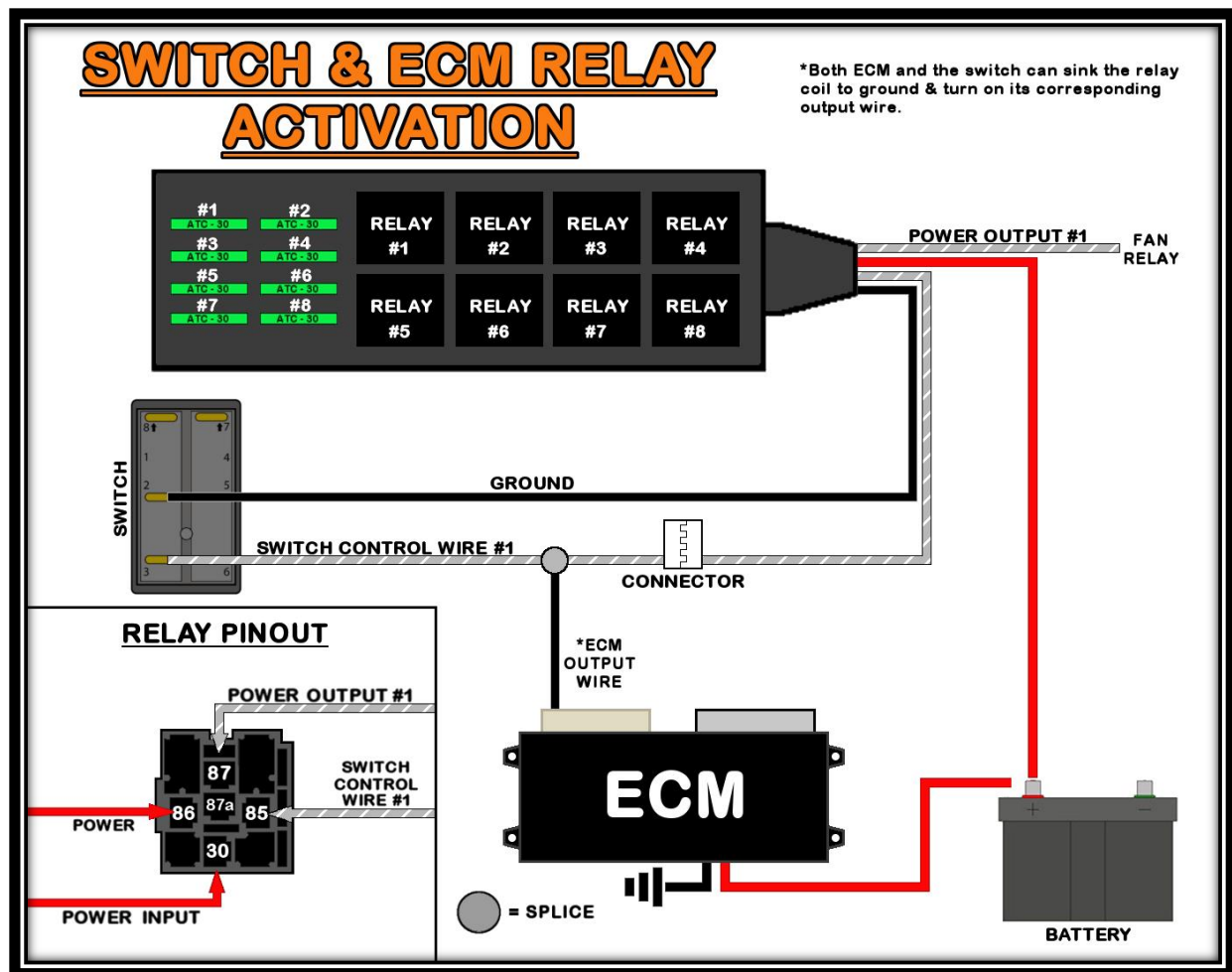

Step 25: Then, splice the ECM Output wire into the Switch Control wire of the switch you wish to use. See [page 9](#) for the wire color chart.

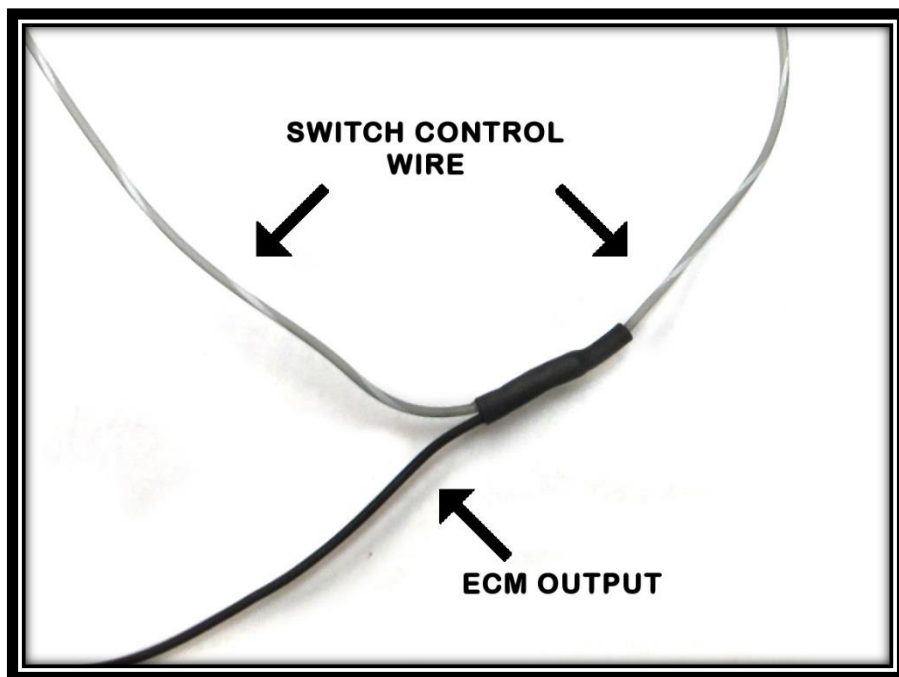

Painless Performance Products LLC

Limited Warranty and Return Policy

Chassis harnesses, fuel injection harnesses, and Track Rocker units are covered under a lifetime warranty.

All other products manufactured and/or sold by Painless Performance are warranted to the original purchaser to be free from defects in material and workmanship under normal use. Painless Performance will repair or replace defective products without charge during the first 12 months from the purchase date. No products will be considered for warranty without a copy of the purchase receipt showing the sellers name, address and date of purchase. You must return the product to the dealer you purchased it from to initiate warranty procedures.

Painless Performance Products LLC
2501 Ludelle Street
Fort Worth, TX 76105
Phone (817) 244-6212