

PAINLESS

PERFORMANCE PRODUCTS

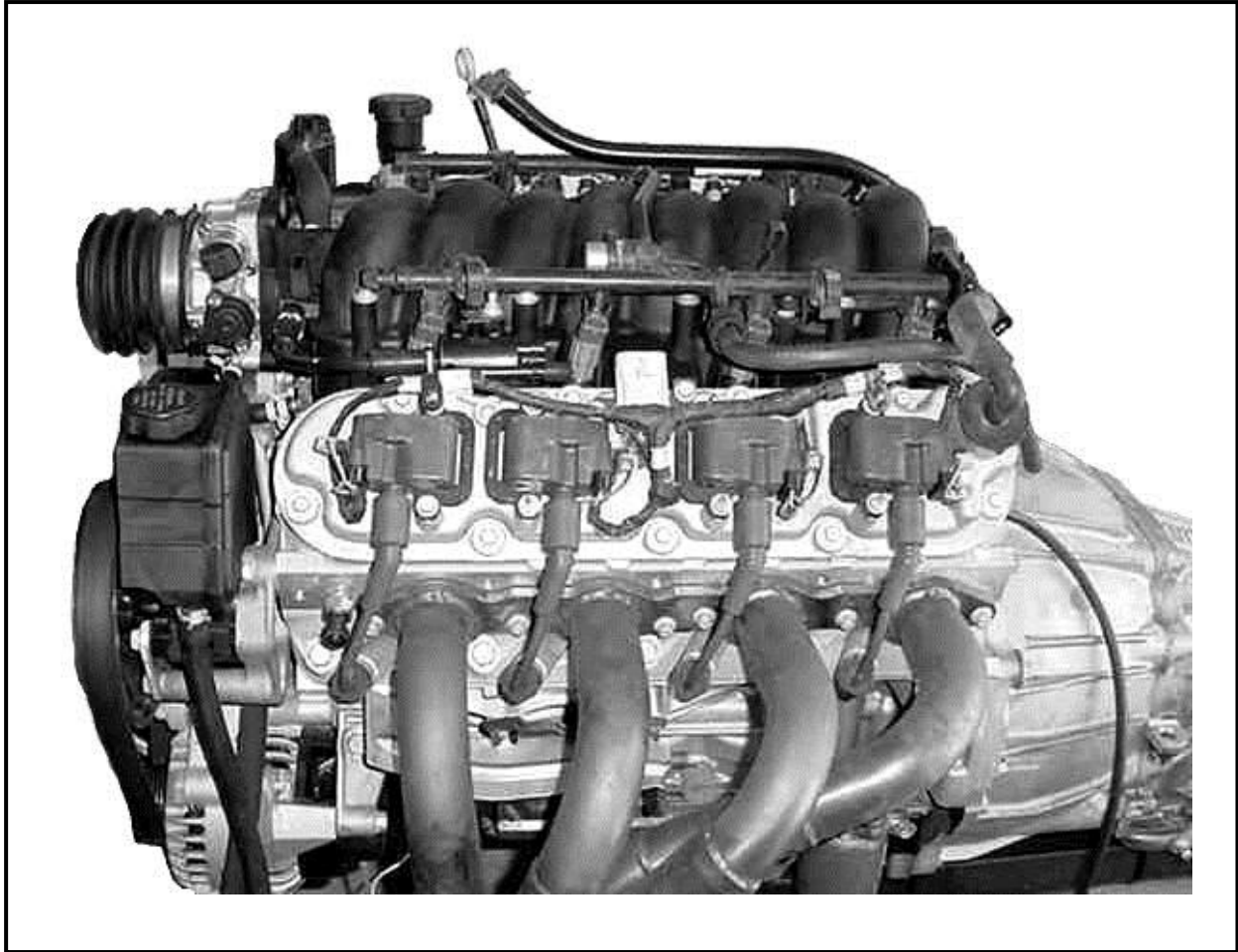

P/N 60508 & 60509
1997-02 GM LS1 w/MECHANICAL (cable)
THROTTLE BODY FUEL INJECTION WIRE
HARNESS INSTALLATION INSTRUCTIONS

Manual P/N 90520

Painless Performance Products, LLC

2501 Ludelle Street

Fort Worth, TX 76105-1036

800-423-9696 phone – 817-244-4024 fax

Web Site: www.painlessperformance.com

E-Mail: painless@painlessperformance.com

If you have any questions concerning the installation of this product, feel free to call **Painless Performance Products'** tech line at 1-800-423-9696. Calls are answered from 8am to 5pm central time, Monday thru Thursday, 8am-4:30pm Friday, except holidays.

Here we have provided you with accurate instructions for the installation of this product. However, if you have comments/suggestions concerning these instructions, please call or email us (our contact information can be found at the top of this page or online at **www.painlessperformance.com**). We sincerely appreciate your business.

Painless Performance Products, LLC shall in no event be liable in contract or tort (including negligence) for special, indirect, incidental, or consequential damages, such as but not limited to, loss of property, or any other damages, costs or expenses which might be claimed as the result of the use or failure of the goods sold hereby, except only the cost of repair or replacement.

Should you damage or lose part of your manual, a full color copy of these instructions can be found online at www.painlessperformance.com

Installation Manual: **90520**

9th Edition: August, 2014

Copyright © 2001 by Painless Performance Products, LLC

TABLE OF CONTENTS

1.0	INTRODUCTION.....	2
2.0	ABOUT THESE INSTRUCTIONS.....	3
3.0	TOOLS NEEDED.....	3
4.0	PRE-INSTALLATION AND HARNESS ROUTING GUIDELINES.....	3
4.1	TRANSMISSION FUNCTION.....	3
4.2	GET TO KNOW THE ENGINE THAT YOU ARE USING.....	4
5.0	GENERAL INSTALLATION INSTRUCTIONS.....	5
5.1	GROUNDING THE VEHICLE.....	5
5.2	ROUGH INSTALLATION.....	5
5.3	HARNESS ATTACHMENT.....	6
5.4	TERMINAL INSTALLATION INSTRUCTIONS.....	6
6.0	GM LS1 SYSTEM WIRE HARNESS INSTALLATION.....	6
6.1	CONTENTS OF THE WIRE HARNESS KIT.....	6
6.2	SPECIFIC CIRCUIT CONNECTIONS.....	7
6.3	ENGINE GROUP INSTALLATIONS.....	10
6.4	TAIL SECTION INSTALLATIONS.....	14
7.0	TROUBLE-SHOOTING INSTRUCTIONS.....	15
7.1	THE "CHECK ENGINE" LIGHT.....	15
7.2	RETRIEVING TROUBLE CODES FROM THE COMPUTER.....	15
7.3	WHEN TO CALL "PAINLESS WIRING" TECH LINE.....	16

LIST OF FIGURES

Figure 6.1	Diagnostic Link Connector (DLC) & Check Engine Light	7
Figure 6.2	Brake Switch Connection	8
Figure 6.3	Brake Switch Relay.....	8
Figure 6.4	Gear Indicator Switch	9
Figure 6.5	Fuel Pump Relay Connector.....	10
Figure 6.6	Knock Sensor Connector.....	11
Figure 6.7	MAP Sensor.....	11
Figure 6.8	CMP Sensor.....	12
Figure 6.9	CKP Sensor.....	12
Figure 6.10	Passenger Side Coil Connector.....	12
Figure 6.11	Injectors 2, 4, 6, 8.....	12
Figure 6.12	TPS Sensor.....	12
Figure 6.13	IAC.....	12
Figure 6.14	Injectors 1, 3, 5, 7.....	13
Figure 6.15	Driver Side Coil Connector.....	13
Figure 6.16	ECT Sensor.....	13
Figure 6.17	MAF Sensor.....	13
Figure 6.18	IAT Sensor.....	13
Figure 6.19	O2 Sensor.....	13
Figure 6.19	VSS (4L60E).....	14
Figure 6.20	Transmission Connection (4L60E).....	14
Figure 6.21	Transmission Connections (T56 manual).....	15
Figure 7.1	Fuse Identification.....	15

LIST OF TABLES

Table 6.1	Dash Section Connections.....	10
Table 6.2	Engine Section Connections.....	11
Table 6.3	Tail Section Connections.....	14

1.0 INTRODUCTION

We at Painless Performance Products believe you have purchased the most up-to-date and easiest to install automotive fuel injection harness on the market. All components to this harness are new. All harnesses are tested for faults before they leave the factory floor. This harness is designed for easy installation, even if you have no electrical experience.

The 60508/60509 harnesses are designed to be a complete wiring system for the fuel injection system on a 1997-02 LS1 with a mechanical (cable) throttle body and T56 manual or a 4L60E automatic transmission. Non electronic controlled transmission such as a Turbo 400/350 or 700r4 may also be used, but additional wiring may be required and must be supplied by the installer. This harness may also be used on 1999-2006 Vortec 4.8, 5.3, 6.0 engines that have had an LS1 intake and mechanical throttle body installed.

Factory computers from 1999-02 Camaros or Firebirds, equipped with the LS1, may be used with this harness. These computers were service number **9354896** or **12200411**; **the 60508/60509 will only work with one of these ECM part numbers that has been flashed with a V8 operating system**. Some 12200411 ECMs were used in other applications. If you are unsure of an ECM's origin, such as purchasing one second hand through the internet or a wrecking yard, contact Painless and purchase an ECM guaranteed to work). An ECM with the wrong operating system will be useless.

These harnesses include all wiring that is needed by the computer to run and control the fuel injection system and transmission. This harness will get the LS1 engine and transmission up and operating. It is recommended that you have the computer reprogrammed to remove anything in the original factory programming that relates to a device or devices that are not being used in your particular vehicle.

NOTE: Most likely the check engine light will come on and stay on when using a computer with the original factory programming. This is normal and is why we recommend that the computer be reprogrammed.

NOTE : This computer must be reprogrammed to remove the Vehicle Anti Theft System (VATS) This service is available thru Painless Performance. Contact us at 800-423-9696, or on the web at www.Painlessprformance.com for more details

NOTE: Most remanufactured computers come without any programming in them and must be programmed before they can be used.

NOTE: The program in your computer must match the transmission that you plan on using. You cannot run a 4L60E transmission with a computer programmed for a T56.

Usually, the computer relays and fuse block can easily be mounted under the dash. Most of the wiring in the harness has been pre-terminated to the proper connector and all wire has been GM color-coded. All wiring is TXL, 600 volt, and 125 degree centigrade with cross-link insulation.

These fuel injection system harnesses have been divided into the following three major groups:

ENGINE GROUP	Includes wiring for the fuel injectors, alternator, ignition system, and sensors.
DASH GROUP	Includes ignition feed wire, assembly line diagnostic link (DLC) connector, check engine light, computer connectors, brake switch wiring, gear shift indicator wiring, tachometer signal, fan relay control, fuse block, fuel pump relay connector (These emission sections are not included in the 60508-9 harnesses) air pump, air bleed, canister purge, canister vent, air pump and air solenoid relays.
TAIL GROUP	Includes VSS wiring, transmission wiring and a power wire for the fuel pump.

2.0 ABOUT THESE INSTRUCTIONS

These instructions provide information for the installation of the 60508 & 60509 LS1 fuel injection harness kits. The contents of these instructions are divided into the following major sections:

- 1.0 INTRODUCTION
- 2.0 ABOUT THESE INSTRUCTIONS
- 3.0 TOOLS NEEDED
- 4.0 PRE-INSTALLATION AND HARNESS ROUTING GUIDELINES
- 5.0 GENERAL INSTALLATION INSTRUCTIONS
- 6.0 GM LS1 FUEL INJECTION HARNESS KIT
- 7.0 TROUBLE-SHOOTING INSTRUCTIONS AND TROUBLE CODES

Sections are further divided into **Paragraphs** and **Steps**. Throughout, the **Figure** numbers refer to illustrations and the **Table** numbers refer to information in tables. These are located in or near the sections or paragraphs to which they correspond. Always pay careful attention to any notes or any text labeled **CAUTION**.

3.0 TOOLS NEEDED

In addition to your regular tools, you will need, at least, the following:

- Crimping tool **NOTE:** **USE A QUALITY TOOL TO AVOID OVER-CRIMPING.**
- Wire stripper
- Continuity tester **CAUTION:** **DO NOT USE A TEST LIGHT TO TEST THE COMPUTER OR SENSOR WIRING. YOU WILL DAMAGE THE COMPUTER.**

- Electric drill
- 1 5/8" Hole saw (for the rubber grommet in the firewall)

4.0 PRE-INSTALLATION AND HARNESS ROUTING GUIDELINES

The installation of your harness kit will consist of two parts:

- ~ The physical routing, positioning, and securing of the harness, wire groups, and individual wires and connectors.
- ~ The proper electrical connection of the individual circuits.

We cannot tell you how to route the harness in your vehicle. That depends a great deal upon the particular make of the vehicle and what extent you want to secure and conceal the harness. We do offer some general guidelines and routing practices starting in **Paragraph 5.3**, general installation instructions in **Section 5.0**, and precise instruction concerning the electrical connections you will have to make beginning in **Section 6.0**. To help you begin thinking through the installation of your wire harness, read the following sections:

4.1 TRANSMISSION FUNCTION

If you are using the T56 transmission, read **Paragraph 4.1.1**, then skip to the note at the end of the page. If you are using the 4L60E, then skip **Paragraph 4.1.1**, and start at **paragraph 4.1.2**.

- 4.1.1** If you are using a **T56 transmission**, tape off and store the purple and pink (brake switch) wires, the orange/black and black/white (gear indicator switch) wires in the dash group and the 13-position (transmission) round connector in the tail section. Plug in the skip shift solenoid, reverse lockout solenoid and vehicle speed sensor connector to the transmission as shown in **Figure 6.28**. We have included a wire to turn on a skip shift light if you are planning on using one. This wire is white/black and provides a ground to the skip shift light. You must connect power to the other side of the light.

4.1.2 If you ARE going to use a **4L60E transmission**, tape off and store the skip shift light wire, skip shift solenoid and reverse lockout solenoid connectors. You must use the vehicle speed sensor (VSS), correct brake switch and a gear indicator switch. These are necessary to make the transmission work correctly. The brake switch should be closed (electrically connected) when the brakes **ARE NOT** being applied and open (not electrically connected) when the brakes **ARE** being applied. This is the opposite of a standard brake light switch. If you are using a pressure brake switch, a **SPDT** relay must be installed to unlock the converter when the brakes are applied.

4.2 YOU SHOULD GET TO KNOW THE PARTICULAR ENGINE YOU ARE USING:

NOTE: The 1997-02 LS1 engine had four oxygen sensors from the factory. We have included provisions for only two oxygen sensors, which include one on the driver side and one on the passenger side of the engine. We have removed the two rear oxygen sensors since they originally were behind the catalytic converters and most people don't want to run more than two oxygen sensors.

4.2.1 Painless Performance recommends the use of the following parts. The numbers given are GM and AC Delco part numbers.

Main Computer.....	Service #9354896	TPS Sensor.....	GM #17123852
	Service #12200411		Delco #213-912
	Painless #60700	MAP Sensor.....	GM #16212460
Fuel Pump Relay.....	Painless #80130		Delco #213-331
Brake Switch.....	Delco #D850A	Idle Air Control Motor.....	GM #17113391
Gear Indicator Switch.....	Delco #D2286A	Knock Sensors.....	GM #10456603
Intake Air Temperature.....	GM #12160244		Delco# 213-362
	Delco #213-243	Coils.....	GM #12558948
MAF Sensor.....	Delco #213-4657		Delco# D580
Engine Coolant Temperature.....	GM #5326388	Cam Position Sensor.....	GM #12561211
	Delco #213-953		Delco# 213-363
Oxygen Sensor (Pass. Side).....	GM #25312196	Crankshaft Position Sensor.....	GM #12560228
	Delco #AFS123		Delco# 213-354
Oxygen Sensor (Drvr. Side).....	GM #25312197	VSS(4L60E Only).....	Delco# 213-328
	Delco #AFS98		

4.2.2 Familiarize yourself with the harness by locating each of the harness groups and by looking at the connectors on the wire ends.

4.2.3 Decide where and how the computer, fuse block and relays will be mounted. Painless wire harness kits are designed to mount either under the dash or in the kick panel on the passenger side. They must be no further apart than the wiring will allow (approx. 18 inches).

4.2.4 A good exercise is to lay out the wire harness on the floor beside your vehicle and identify all the connectors and wires.

4.2.5 You will want to route the harness through and around open areas. Inside edges provide extra protection from hazards and also provide places for tie wraps, clips and other support. Route the harness away from sharp edges, exhaust pipes, and the hood, trunk and door hinges.

4.2.7 Plan where harness supports will be located. Use a support approximately every 6 inches unless the harness routes under the floor carpet.

4.2.8 Allow enough slack in the harness at places where movement could possibly occur

4.2.9 The wires should be bundled into harness groups. Use tape, nylon ties or poly split loom.

5.0 GENERAL INSTALLATION INSTRUCTIONS

CAUTION:

- ~ DO NOT DISCONNECT THE BATTERY OR THE COMPUTER CONNECTORS WHILE THE IGNITION IS ON.
- ~ DO NOT SHORT ANY WIRES IN THIS HARNESS TO GROUND (WITH THE EXCEPTION OF LABELED GROUND WIRES) OR DAMAGE TO THE COMPUTER WILL RESULT.
- ~ GIVING OR RECEIVING A "JUMP START" MAY DAMAGE THE COMPUTER.
- ~ DO NOT USE A TEST LIGHT WHEN TESTING COMPUTER SENSORS OR COMPUTER CIRCUITS. DAMAGE TO THE COMPUTER WILL RESULT!
- ~ WHEN ROUTING THE WIRES FOR THE VEHICLE SPEED SENSOR (IF USED) MAKE CERTAIN THAT THEY ARE AT LEAST 12 INCHES AWAY FROM ANY IGNITION WIRING (SPARK PLUG WIRES, ETC.).

Notes:

- ~ There is a normal, small current drain on these fuel injected systems.
- ~ Each connector in this harness is different and will not fit in the wrong place. **NEVER FORCE ANY CONNECTOR.**
- ~ When connecting the plugs to the computer **USE EXTREME CARE** to make sure none of the pins in the computer are or become bent.
- ~ The fuel pump and pressure regulator you are using **MUST** maintain a constant pressure of **55-60 PSI** (pounds per square inch). If using a higher pressure pump you must add an inline regulator to bring the pressure down to the 55-60 range since the LS1 fuel system does not have a built-in regulator on the fuel rail as in many earlier GM fuel injection systems.

5.1 GROUNDING THE VEHICLE

A perfectly and beautifully wired vehicle will nevertheless have problems if everything is not properly grounded. Don't go to the effort to installing a quality wire harness only to neglect proper grounding.

Note: The installer of this harness is responsible for all ground wires not provided with this part.

- 5.1.1 Connect a ground strap or cable (minimum of a 4 Ga. wire) from the negative battery terminal to the chassis (frame).
- 5.1.2 Connect a ground strap (minimum of a 4 Ga. wire) from the engine to the chassis (frame). **DO NOT RELY UPON THE MOTOR MOUNTS TO MAKE THIS CONNECTION.**
- 5.1.3 Connect a ground strap from the engine to the body.

5.2 ROUGH INSTALLATION

CAUTION: **DISCONNECT THE POWER FROM YOUR VEHICLE BY REMOVING THE NEGATIVE BATTERY CABLE FROM THE BATTERY.**

Note: Make no wire connections or permanent mounting of any kind at this time.

- 5.2.1 Position the computer and sensors in their intend locations.
- 5.2.2 Drill a 1-5/8" hole for the firewall grommet near the computer for the engine group and tail section to pass through.
- 5.2.3 Route the engine group and tail section through the hole. Push the grommet (already installed on the harness) into the hole until it is seated.
- 5.2.4 Route the dash group over to the driver's side of the car.
- 5.2.5 Route the fuse block and relays to the place they will be mounted.

5.3 HARNESS ATTACHMENT

Note: Harness routing and shaping will be a time-consuming task. Taking your time will enhance the beauty of your vehicle. Please take your time and be patient.

- 5.3.1 Permanently mount your computer. You should mount the fuse block and relays at this time.
- 5.3.2 Mold harness groups to the contour of the dash, engine, frame, etc. Remember to route harness away from sharp edges, exhaust pipes, hinges, and moving parts.
- 5.3.3 Attach harness groups to your vehicle with clips or ties starting at the computer and working your way outward.

Note: Do not tighten tie wraps or mounting devices at this time. Make all harness attachments LOOSELY.

- 5.3.4 When used every 1-1/2" or so on the visible areas of the harness, colored plastic wire ties make a very attractive assembly. Otherwise, a tie installed in other areas every 6" or so will hold the wires in place securely. **REMEMBER TO TAKE YOUR TIME.**

5.4 TERMINAL INSTALLATION INSTRUCTION

Note: In the following steps you will be making the circuit connections. Before you start, you should carefully read Sections 6.0, and continually refer to the wire charts, DOUBLE CHECKING your length calculations before cutting any wire or making any connections. These directions are for the wires, which do not have a connector already, installed on them.

- 5.4.1 Have all tools and connectors handy.
- 5.4.2 Select the correct terminal for the wire and application.
- 5.4.3 Determine the correct wire length and cut the wire. Remember to allow enough slack in the harness and wires at places where movement could occur. **DOUBLE CHECK YOUR CALCULATIONS.**
- 5.4.4 Strip insulation away from wire. Only strip as much insulation off as necessary for the type of terminal lug you are using.

Note: In the following step, make sure that the terminal is crimped with proper die in the crimping tool. An improper crimp will not make a good connection. **DO NOT OVER-CRIMP.**

- 5.4.5 Crimp the terminal onto the wire.
- 5.4.6 Connecting the wires and connectors throughout the harness is a simple process. Make sure that each wire is properly routed and then attached. **DO NOT ATTACH THEN ROUTE AFTERWARD.**
- 5.4.7 When all the wires are attached, tighten the mounts and ties to secure the harness permanently.
- 5.4.8 Attach the connectors to the computer. **BEING VERY CAREFUL NOT TO BEND ANY PINS.**
- 5.4.9 After all connections have been made throughout the harness, connect the battery to the vehicle.

CAUTION: BE SURE THE IGNITION IS OFF WHEN YOU RECONNECT THE BATTERY OR YOU WILL DAMAGE THE COMPUTER.

6.0 GM 97 - 99 LS1 SYSTEM WIRE HARNESS INSTALLATION INSTRUCTIONS

6.1 CONTENTS OF THE 60508/60509 WIRE HARNESS KIT

Take inventory to see that you have everything you are supposed to have in this kit. Should you notice something missing, contact the dealer where you obtained the kit or Painless Performance at (817) 244-6898. The kit should contain the following items:

- ~ The main wire harness with the connectors already on the ends of most of the wires.
- ~ Fuel Injection Installation Instructions P/N 90520 (This Booklet).
- ~ 4" & 7" tie wraps.

6.2 SPECIFIC CIRCUIT CONNECTIONS

Note: If you have not already done so, read sections 4.0 and 5.0 of these instructions and think through the installation of the harness before securing or cutting any wires.

6.2.1 DASH SECTION INSTALLATION

The wires in this group consist of the diagnostic link connector (DLC) (SEE FIGURE 6.1), the check engine light (pre-mounted into a mounting bracket), and 14 other wires.

Note: You may need to connect the check engine light wires to their mates in the wire harness.

CAUTION: DO NOT MAKE ANY CONNECTIONS WHILE THE COMPUTER IS PLUGGED INTO THE HARNESS.

Note: Wire color (Example: Blk/Wht) is one wire with a stripe. The second color (the stripe) may not be bold. Observe all two-color wires closely.

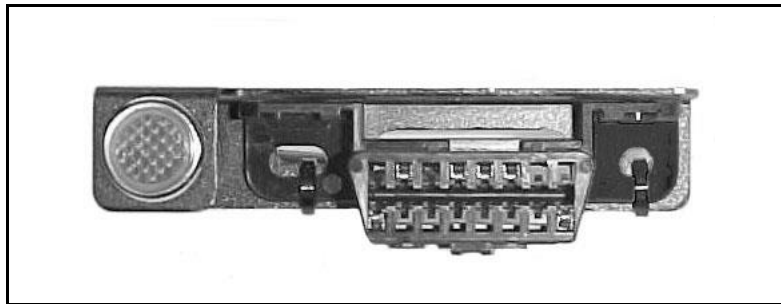

FIGURE 6.1 DLC Connector & Check Engine Light

- A. Find a suitable location to mount the DLC connector (using the bracket that the light is mounted in) that will allow access to the front of the connector and still allow you to see the light while driving.
- B. Mount the DLC connector using the bracket containing the check engine light in the place selected.
- C. Locate the pink ignition hot activation wire, labeled FUSE BLOCK IGNITION (18 Ga.) and attach it to a 12V **fused** source where there is power **WHEN THE KEY IS IN THE START AND RUN POSITION**. This wire activates the relays that supply power to all the ignition hot circuits in the fuel injection harness. If the pink wire is connected correctly, the check engine light will come on when the ignition switch is in the "ON or START" position.
- D. Locate the Orn/Blk and Blk/Wht wires in the dash group. These two wires are for the Gear **INDICATOR** Switch, **NOT** the Neutral Safety Switch. If you have a GM column then you can use the combination switch Delco P/N D2286A and wire it as described in paragraph 2 or 3 below. The ORN/BLK wire needs to be grounded in "Park and Neutral" and ungrounded in "Drive". This can also be done with a toggle switch or a switch on the parking brake.

NOTE: The Orn/Blk and Blk/Wht wires are only needed if using a 4L60E transmission. If you are using a manual transmission then you will tape and stow these wires.

CAUTION: DO NOT CONNECT THESE WIRES USING DIRECTIONS FROM DIFFERENT PARAGRAPHS. YOU MAY DAMAGE THE COMPUTER.

- D.1. The recommended switch is a combination reverse light, gear indicator **AND** neutral safety switch. You may use it for all these purposes if you wire it **EXACTLY** as shown in **Figure 6.4 Illustration B**
- D.2. If you are going to use the recommended switch as a gear indicator for the computers benefit **ONLY**, then you will wire it as shown in **Figure 6.4 Illustration A**.
- D.3. You may want to install your own switch. This switch must connect the Orn/Blk wire to ground only when the car is in **PARK OR NEUTRAL**. You may or may not want to use the Blk/Wht wire. The other end of the Blk/Wht wire is already grounded throughout the harness.
- E. The purple and pink wires labeled BRAKE SWITCH are the wires that connects to the brake switch to let the computer know when the brake is applied. If you **ARE NOT** using a 4L60E then you will tape off and store these wires. If you **ARE** using the 4L60E transmission then you will have to install an electrical switch described in **Paragraph 4.1.2**. The pink wire provides power for this switch and the purple wire is the signal going to the computer.
- F. If you are using the recommended brake switch then you will wire it according to **Figure 6.2**. The pink wire to the back of the switch in the illustration is the wire that has power on it whether or not the brake is being applied.

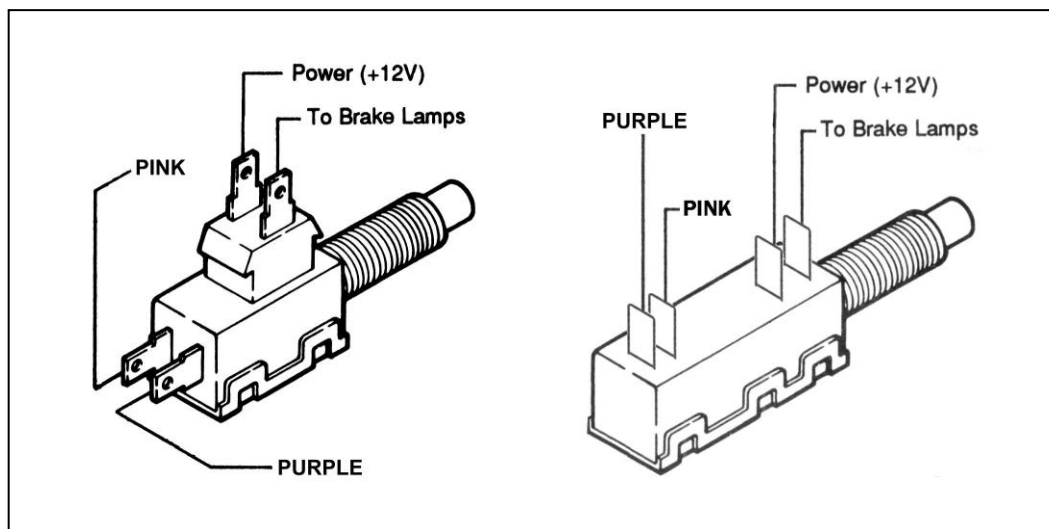

FIGURE 6.2 Brake Switch Connections

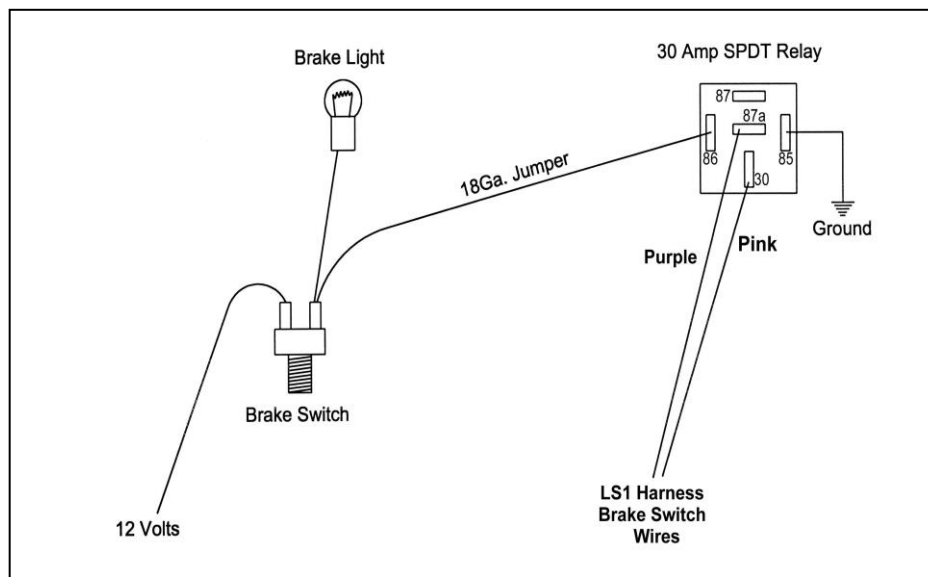

FIGURE 6.3 Brake Switch Relay

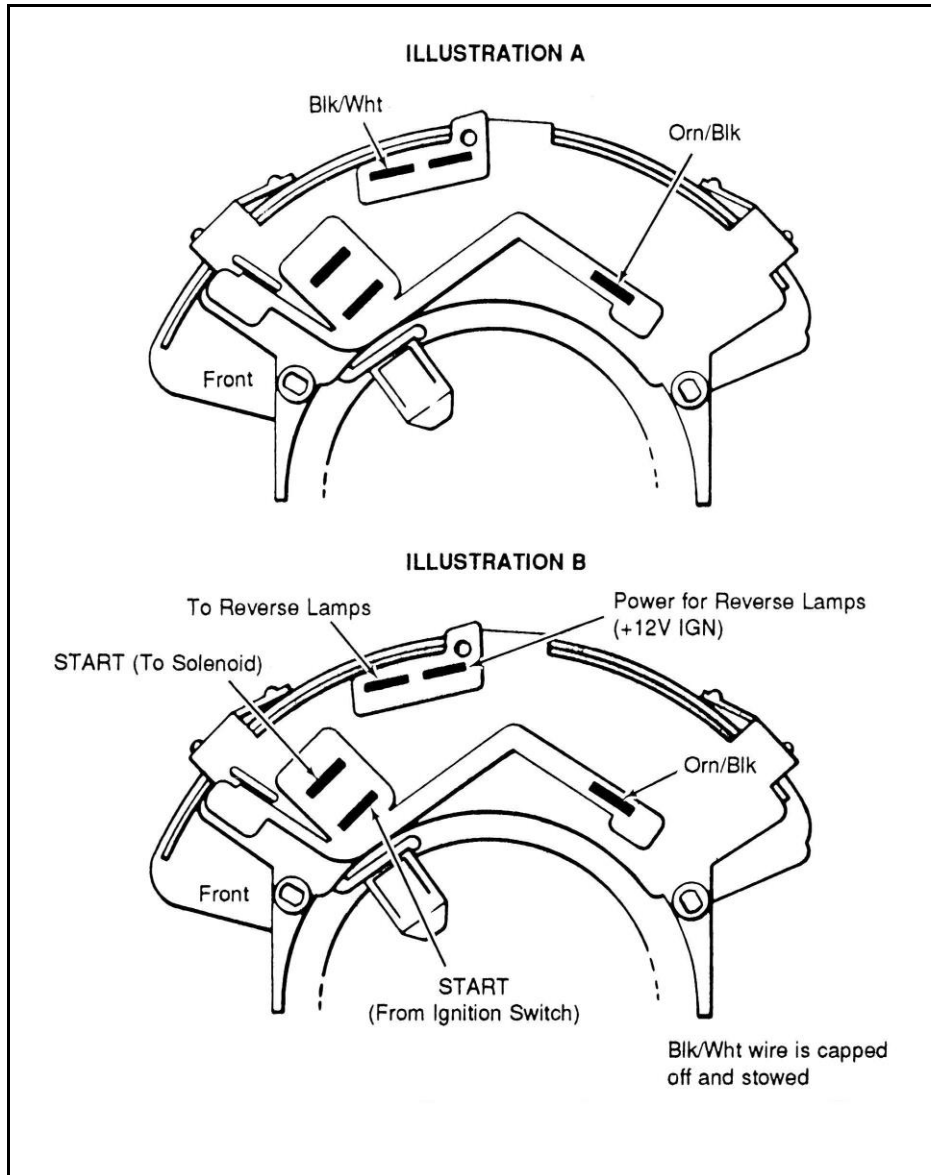

FIGURE 6.4 Gear Indicator Switch

CAUTION: FAILURE TO WIRE THIS SWITCH CORRECTLY WILL RESULT IN A DANGEROUS SITUATION ON THE VEHICLE.

- G.** If your vehicle has a pressure type brake switch, you may use a relay as shown in **Figure 6.3**. The relay must be a **SPDT Relay** and wired correctly or it could result in a dangerous situation with the vehicle. The torque **converter may not unlock**.

The wire labeled FUEL TEST is a test point for the fuel pump. After the vehicle has been wired and tested OK, tape off this wire and store it in the harness.

- I.** Fan #1 relay wire (green) and fan #2 relay wire (blue) are relay ground wires activated by the computer.

Note: Fan #1 will come ON at 226°f and go OFF at 217°f.

Fan #2 will come ON at 235°f and go OFF at 226°f.

- J.** The wire labeled TACH (white) is the signal wire for a tachometer if used.

- K. The VSS output wire (green/white) sends out a signal to operate the electronic cruise control or speedometer if so equipped.
- L. The wire labeled SKIP SHIFT LIGHT (white/black) is only used with the T56 manual transmission. The computer grounds this wire to turn on the skip shift light if used.
- M. The fuel pump relay is activated by the ECM and will send power to an electric fuel pump. Mount the relay and insert the supplied relay into this connector.

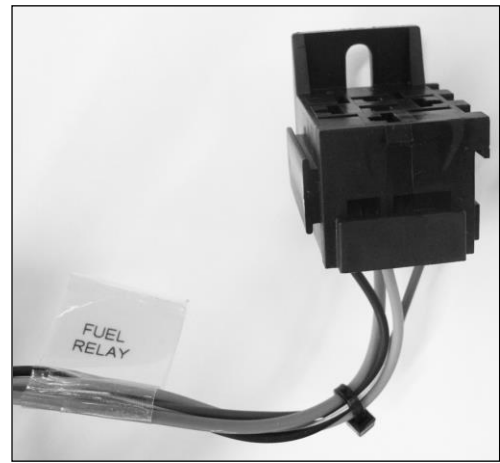

FIGURE 6.5 Fuel Pump Relay Connector

6.2.2 Dash Section Connections

WIRE COLOR	# OF POSITIONS IN CONNECTOR	LABELED	CONNECT TO:
Gray, Green/White, Black, Orange	4	Fuel Relay	Fuel Pump Relay
Green/White		VSS Output	Speedometer
White		Tach	Tachometer
Orange/Black, Black/White		Gear Indicator Switch	Gear Indicator Switch
Pink, Purple		Brake Switch	Brake Switch
Pink		Fuse Block Ignition	Ignition Power
Green		Fan #1 Relay	Coolant Fan #1 Relay
Blue		Fan #2 Relay	Coolant Fan #2 Relay
White/Black		Skip Shift Light	Skip Shift Light (T56 Trans. Only)

TABLE 6.1 Dash Section Connections

6.3 ENGINE GROUP INSTALLATION

The engine group is designed to be separated into left side (driver) and right side (passenger) sections. Each side is tie-wrapped separately, **BUT NOT LABELED**. The left side of the engine has the connectors for the idle air control, throttle position sensor, and engine coolant sensor, all of which **ARE** labeled. When you begin routing, **FIRST** separate the engine group into left and right sections and place them accordingly.

- 6.3.1 Before you connect any wires, separate the tail section from the engine group and place it out of the way.
- 6.3.2 Connect the two ring terminals labeled STARTER B+ with Red wires to the large battery terminal on the starter solenoid.
- 6.3.3 Locate the three large ring terminals with Black and Blk/Wht wires and ground them to the engine. These must be on 3 separate bolts, **DO NOT CONNECT ALL TO THE SAME GROUNDING POINT**. Under no circumstance should all 3 ring terminals be connected to the same bolt.
- 6.3.4 Using **Figure 6.11-6.25**, and the specific connections indicated in **Table 6.2A or 6.2B**, connect the wiring as directed.

NOTE: The air pump, air bleed solenoid, canister purge solenoid and canister vent solenoid connectors are rolled up in the dash section and must be routed out to the engine compartment if these items are to be used.

6.3.5 Engine Section Connections

WIRE COLOR	# OF POSITIONS IN CONNECTOR	LABELED	CONNECT TO:
Blue, Lt.Blue	2	Knock	Knock Sensor Connector
Tan/White, Purple/White, Black, Pink	4	Drvr Side Oxy	Driver Side Oxygen Sensor
Tan, Purple, Black, Pink	4	Pass Side Oxy	Passenger Side Oxygen Sensor
Orange/Black, Lt.Green, Gray	3	MAP	MAP Sensor
Brown/White, Red, Pink/Black	3	CMP	Cam Position Sensor
Blue/White, Yellow/Black, Lt.Green	3	CKP	Crankshaft Position Sensor
Pink, Black	2	Inj #1	Driver Side Front Injector
Pink, Lt.Green/Black	2	Inj #2	Passenger Side Front Injector
Pink, Pink/Black	2	Inj #3	Driver Side 2 nd Injector
Pink, Lt.Blue/Black	2	Inj #4	Passenger Side 2 nd Injector
Pink, Black/White	2	Inj #5	Driver Side 3 rd Injector
Pink, Yellow/Black	2	Inj #6	Passenger Side 3 rd Injector
Pink, Red/Black	2	Inj #7	Driver Side Rear Injector
Pink, Blue/White	2	Inj #8	Passenger Side Rear Injector
Blue, Black, Gray	3	TPS	Throttle Position Sensor
Yellow, Black/White, Pink	3	MAF	Mass Airflow Sensor
Black, Yellow	2	ECT	Engine Coolant Temp Sensor
Purple, Tan	2	IAT	Intake Air Temp Sensor
Lt.Green/Black, Lt.Blue/Black, Lt.Blue/White, Lt.Green/White	4	IAC	Idle Air Control Motor
Purple, Red, Green, Lt.Blue, Brown, Black, Pink	7	Drvr Coils	Driver Side Coil Connector
Red/White, Purple/White, Lt.Blue/White, Green/White, Brown/White, Black, Pink	7	Pass Coils	Passenger Side Coil Connector
Black (3), Black/White (2)		Ground	Engine Ground
Red (2)		Starter B+	Starter Solenoid Batt. Terminal

TABLE 6.2 60508/60509 Engine Section Connections

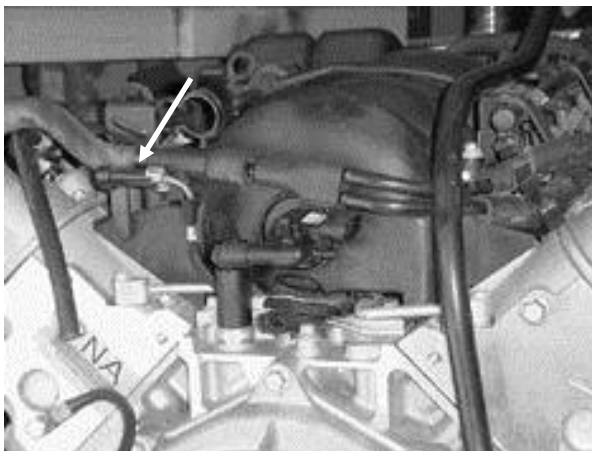

FIGURE 6.6 Knock Sensor Connector

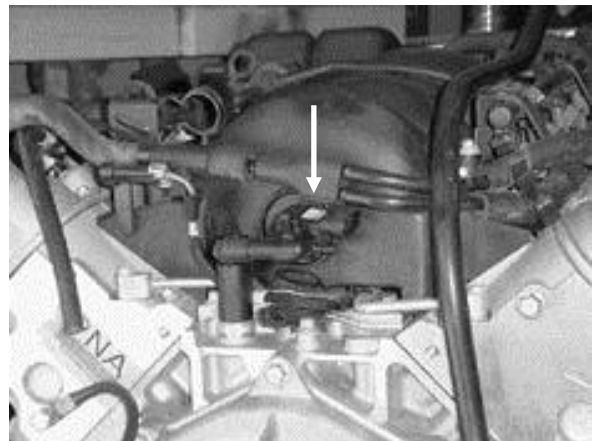

FIGURE 6.7 MAP Sensor

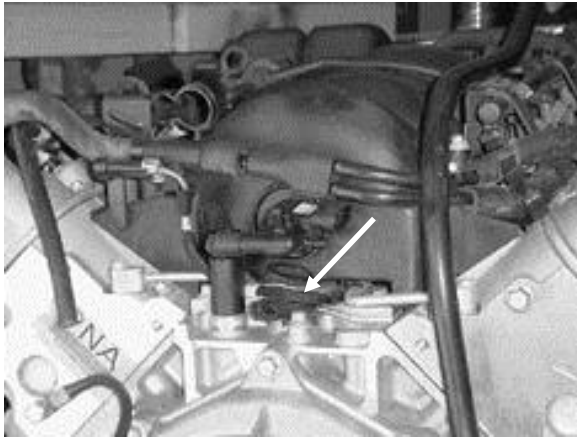

FIGURE 6.8 Cam Position Sensor

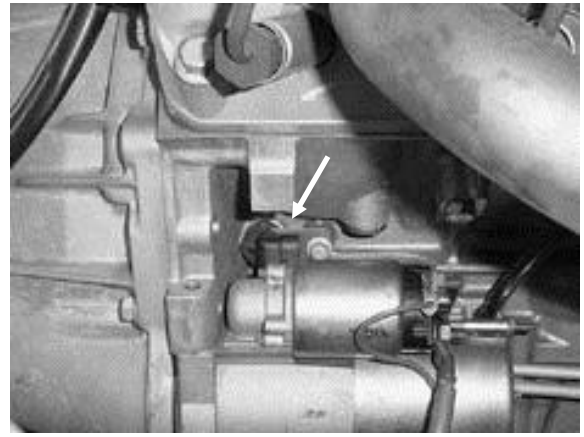

FIGURE 6.9 Crank Position Sensor

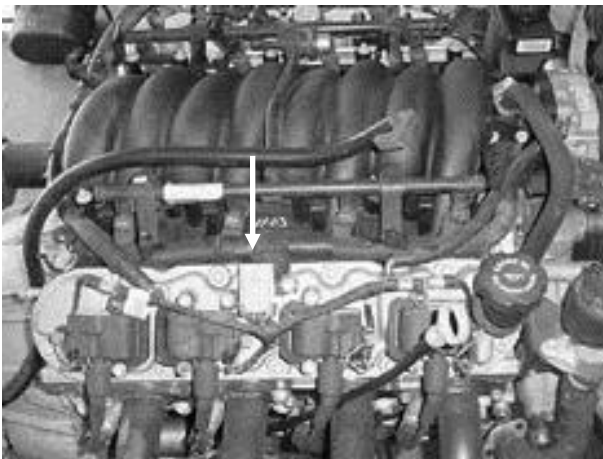

FIGURE 6.10 Passenger Side Coil Connector

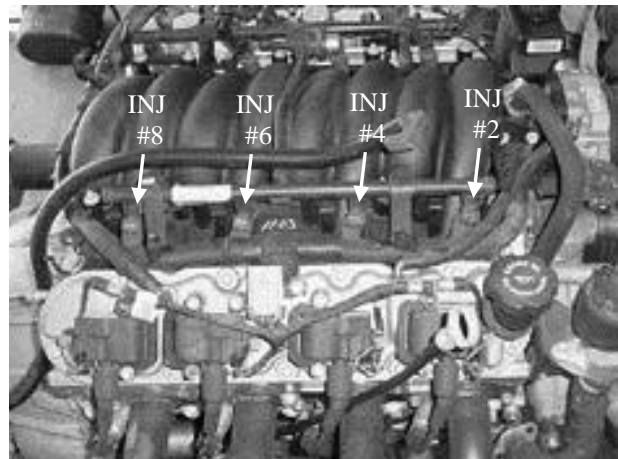

FIGURE 6.11 Injectors 2, 4, 6, 8

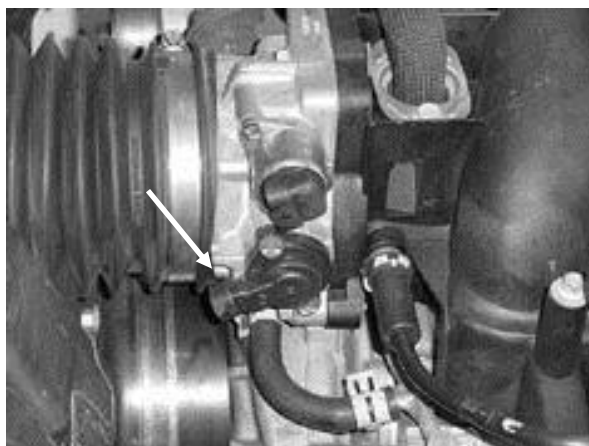

FIGURE 6.12 TPS Sensor

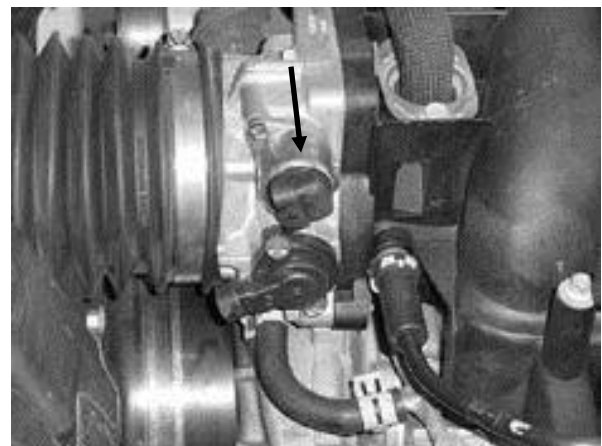

FIGURE 6.13 IAC

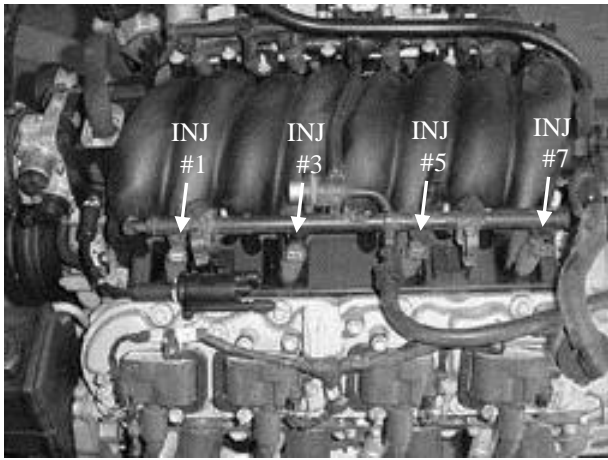

FIGURE 6.14 Injectors 1, 3, 5, 7

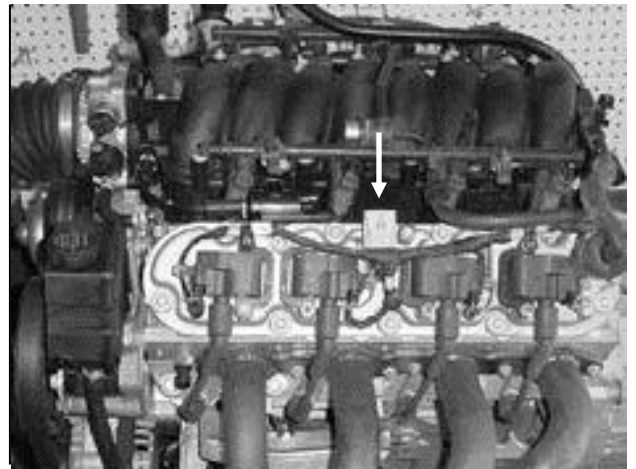

FIGURE 6.15 Driver Side Coil Connector

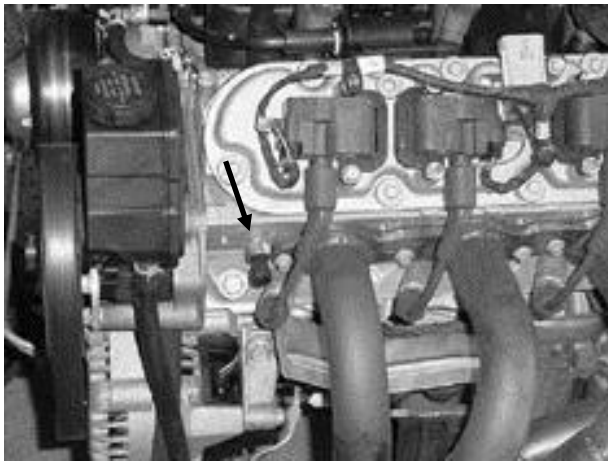

FIGURE 6.16 ECT Sensor



FIGURE 6.17 MAF Sensor



FIGURE 6.18 IAT Sensor



FIGURE 6.19 O2 Sensor

6.4 TAIL SECTION INSTALLATION

- 6.4.1** Locate the tail section that you earlier separated from the engine group. Begin routing it towards the rear of the vehicle. Be sure to avoid all sharp edges, moving or hot parts, or anything else that may damage the harness.
- 6.4.2** If you **ARE** using the 4L60E transmission, route the 13-position connector to the transmission and attach it. Tape up the reverse lockout and skip shift solenoid connectors and store them in the harness.
- 6.4.3** If you **ARE** using the T56 manual transmission, route the reverse lockout and skip shift solenoid connectors to the transmission and attach them. Tape up the 13-position connector labeled TRANS and store it in the harness.
- 6.4.4** Take the connector for the Vehicle Speed Sensor (VSS) and connect to the Vehicle Speed Sensor.
- 6.4.5** Take the gray wire labeled FUEL PUMP and route it to the fuel pump. This is the power wire for the fuel pump.
- 6.4.6 Tail Section Connections**

WIRE COLOR	# OF POSITIONS IN CONNECTOR	LABELED	CONNECT TO:
Purple/White, Lt.Green/Black (60508)	2	VSS	Vehicle Speed Sensor
Pink, Lt.Green	2	Reverse Lockout Sol.	Reverse Lockout Solenoid
Pink, Gray	2	Skip Shift Sol.	Skip Shift Solenoid
Blue, Pink (2), Lt.Green, Red, Brown, Yellow/Red, Orange/Black, White, Tan/Black, Lt.Blue/White, Red/Black, Yellow/Black	13	Transmission	Transmission
Gray		Fuel Pump	Fuel Pump Power Terminal

TABLE 6.3 Tail Section Connections

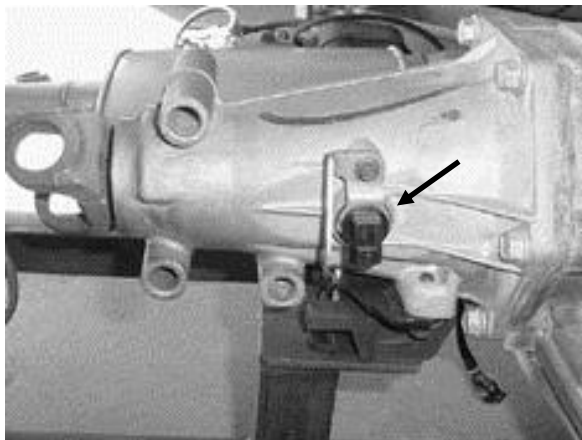

FIGURE 6.19 VSS (4L60E)

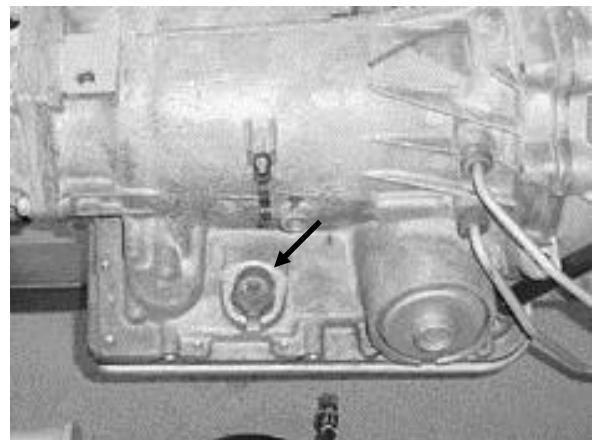

FIGURE 6.20 Transmission Connection (4L60E)

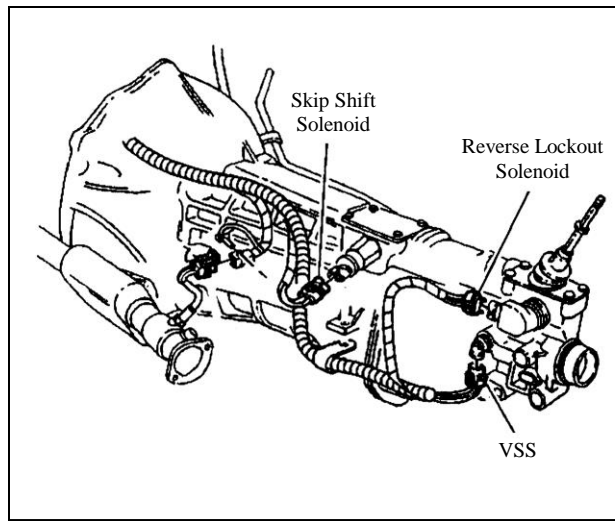

FIGURE 6.21 Transmission Connections (T56)

7.0 TROUBLE- SHOOTING INSTRUCTIONS

If you are having trouble with your engine running badly or not running at all, first perform basic trouble-shooting (ensure that you are using the correct parts (Table 4.1), check for faulty connections, blown fuses, , spark, timing, fuel pressure, etc.), then see if the computer has stored a trouble code in its memory.

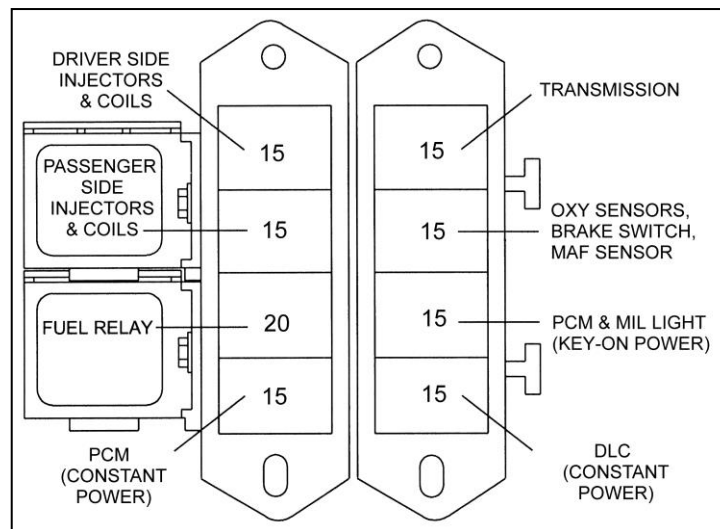

FIGURE 7.1 60508/60509 Fuse Identification

7.1 THE "CHECK ENGINE" LIGHT

Normally, the "check engine" light should come on when the ignition is turned on, then go out a few moments after the engine starts running. If it reappears, or stays on while the engine is running, the computer has detected a problem and a trouble code has been set.

NOTE: Most likely the check engine light will come on and stay on when using a computer with the original factory programming this is normal and is why we recommended that the computer be reprogrammed to remove any items that the factory vehicle had that aren't being used in the vehicle you are installing the engine into.

7.2 RETRIEVING TROUBLE CODES FROM THE COMPUTER

7.2.1 In order to retrieve the trouble codes stored in the computer, a scanner must be connected to the Assembly Diagnostic Link (DLC) connector (installed and connected in **Paragraph 6.2.1**). Follow the instructions provided with the scanner to read the codes set in the computer.

7.2.2 After you have read any codes, write them down for reference. Remove the connector from the DLC connector.

7.2.3 Take the codes one at a time and match them to the codes in a Camaro/Firebird repair manual. This will tell you which circuit the computer has detected a problem.

Note: A code indicates a problem in a specific circuit, **NOT THAT A PARTICULAR PART IS BAD.**

7.2.4 Before taking more extensive corrective actions for any trouble codes make sure that all connections on the indicated circuit, **INCLUDING THE COMPUTER**, are clean and tight. Inspect the wiring in the circuit for any broken, shorted, or exposed wires. Finally, insure all ground wires are clean and secure.

7.2.5 If a trouble code is detected and the problem has been fixed, clear the codes by first making sure the ignition is off then disconnecting the NEGATIVE battery cable for at least 3 minutes.

7.3 WHEN TO CALL PAINLESS PERFORMANCE PRODUCTS' TECH LINE

7.3.1 These harness kits have been built with the highest regard to quality control. Before calling us please double check all connections and perform normal basic trouble-shooting (fuel pressure, timing, ignition system, etc.).

7.3.2 If you have any questions concerning the installation of this harness or having trouble in general, feel free to call Painless Performance Products' tech line at (817) 423-9696. Calls are answered from 8am to 5pm central time, Monday thru Friday, except holidays. Email questions to Tech@painlessperformance.com

We have attempted to provide you with the most accurate instructions possible, and are always concerned about corrections or improvements that can be made. If you have found any errors or omissions, or if you simply have comments or suggestions concerning these instructions, please write us at the address on the cover and let us know about them. Or, better yet, send us a fax at (817) 244-4024. We sincerely appreciate your business.

Painless Performance Limited Warranty and Return Policy

Chassis harnesses and fuel injection harnesses are covered under a lifetime warranty.

All other products manufactured and/or sold by Painless Performance are warranted to the original purchaser to be free from defects in material and workmanship under normal use. Painless Performance will repair or replace defective products without charge during the first 12 months from the purchase date. No products will be considered for warranty without a copy of the purchase receipt showing the sellers name, address and date of purchase. You must return the product to the dealer you purchased it from to initiate warranty procedures.