



# INSTALLATION INSTRUCTIONS

## Fuel Surge Tank Kit

Mitsubishi Lancer Evolution X

Document# 19-0069

Customer Support: [info@radiumauto.com](mailto:info@radiumauto.com)

**CAUTION: Exercise extreme caution when working with the fuel system of any vehicle. Keep flame and sparks away. Clean up all spilled fuel immediately and safely dispose of cleaning supplies. Work in a well-ventilated area.**

-This kit and manual does not cover installation of a Radium Engineering dual pump FST. The plumbing and electrical in this kit was designed for 1 pump. A Radium DIY harness would be required to drive the second FST pump and a second hose from the FST to the fuel rail would be needed.

-This kit and manual also does not cover installation of a Radium FST-R. The plumbing in this kit was designed to reuse the OEM FPR so one of the hoses will not be used and the OEM 1/4" rubber FPR return hose will need to be removed, drained, or plugged. Also, the FPR vacuum hose will need to be extended to the trunk.

1. To release fuel pressure, remove fuel pump fuse and start the engine. The engine will stall. Turn off car and remove negative battery terminal.

Remove all paneling from trunk area. This will expose the area between the battery and the washer fluid reservoir where the fuel surge tank will be mounted, as shown.



2. Remove the washer fluid reservoir lower mounting bolt shown in the picture. Note: This bolt will be replaced with one of the M8 Allen head bolts in the kit.



3. Unclip the washer fluid hose from the plastic clips and re-route the hose as shown.

Remove the white plastic clip on the left hand side (already removed in picture).

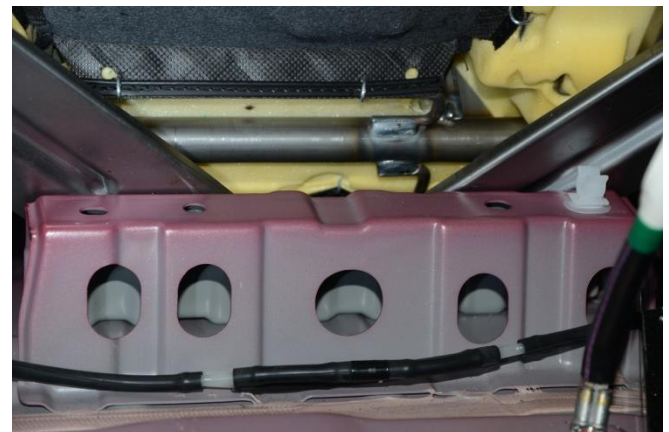

4. Locate the 8mm bolt, nut, and two washers included in the kit.

Place a washer on the bolt, then insert from the bottom up into the body hole shown in the picture.

Install the 8mm nut and tighten.

The included bracket will use this stud as one of the mounting points.

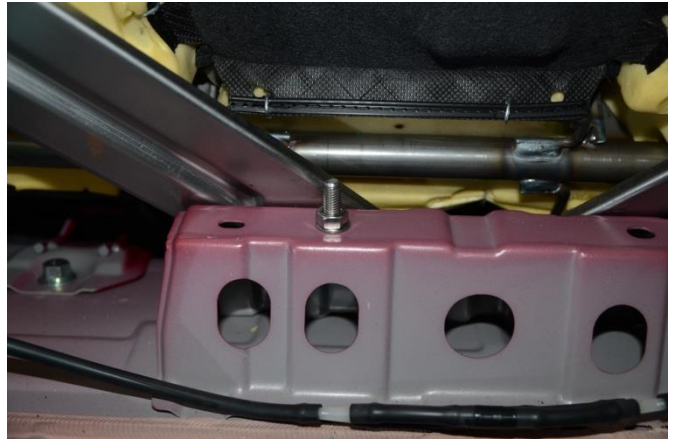

5. Prepare the fuel surge tank by fastening the mounting bracket to the bottom using the four M6 countersink screws included in the kit. Tighten screws.

Orientation of the surge tank is not critical at this point.

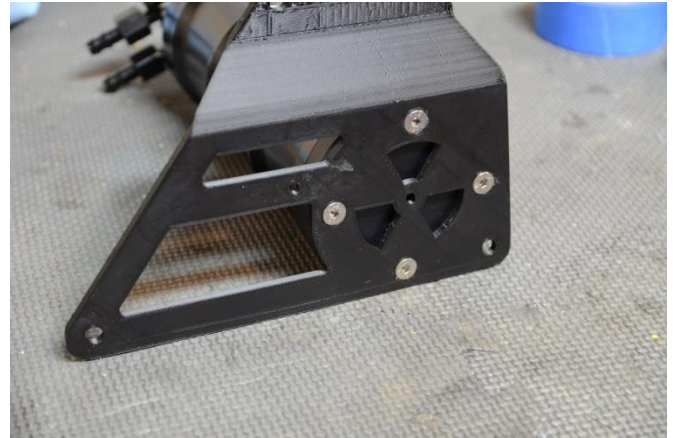

6. Separate flying lead wire harnesses from both the fuse holder and the relay by unplugging them.

Use the included M5 bolt and nut and secure the relay and fuse holder to the FST bracket.

Note: The relay mounts on the top of the mounting bracket and the fuse holder mounts on the bottom using the same nut and bolt, as shown.

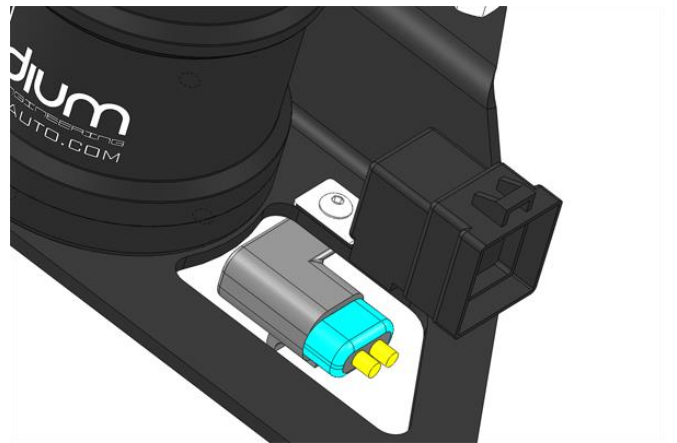

7. Place the fuel surge tank assembly into the location shown and line up the mounting holes.



8. Locate 1 of the M8 Allen head bolts and 2 of the M8 washers in the kit.

First slip 1 of the washers between the fluid reservoir flange and the Radium mounting bracket to shim the Radium mounting bracket upwards.

Next, install the second washer on top of the Radium mounting bracket and then screw in the M8 bolt, as shown.

Do not tighten yet.



9. Locate the spacer in the kit and install under the bracket at the mounting hole shown in the picture.

Next, install the included M8 washer and bolt. Do not yet tighten.

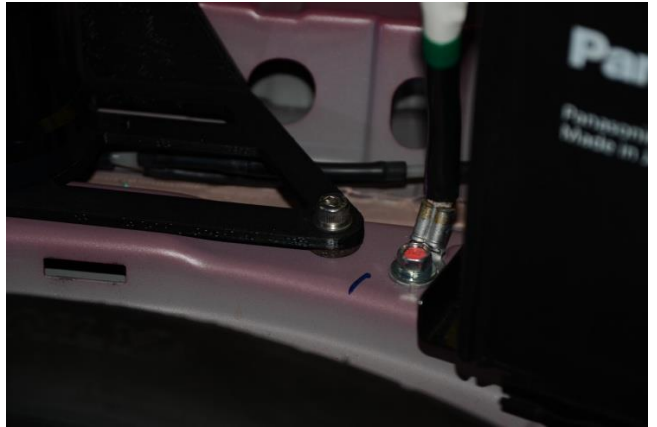

10. At the upper mounting hole, install the 8mm nut and washer included in the kit.

Do not tighten down mounting fasteners until very end of installation.

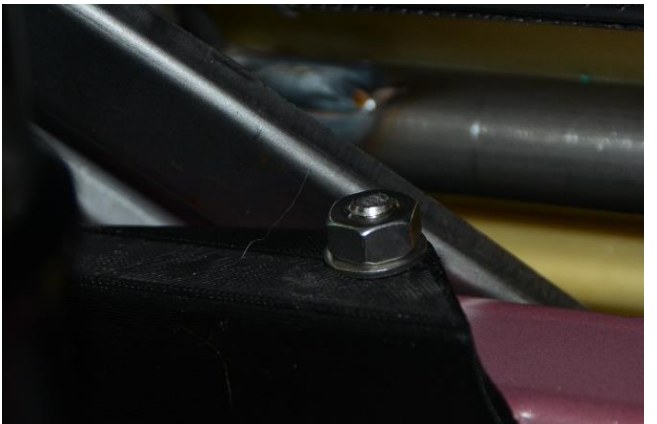

11. Remove the back seat cushions.

Find the fuel pump access panel on the left hand side under the lower seat cushion.

To remove, carefully pull upwards around the perimeter of the panel. It is fastened down with an adhesive caulking, but can be removed and reinstalled easily.



12. With the top of the fuel pump hanger exposed, clean the area with some water and a rag as it will be covered in dirt.

Remove the pressure line by removing the green plastic retaining clip then pulling it off the fitting. Be careful not to side-load the white plastic fitting as it could break. Use a rag to clean up any spilled fuel.

Loosen the hose clamp on the return hose and remove it from the fitting as well (shown still installed in picture).



13. Locate the hose in the kit that does not have a hose end fitting on one end.

Install the quick disconnect fitting included in the kit into the end of this hose.

Use the included hose clamp to secure in place, as shown.

Snap the hose end onto the fuel pump pressure fitting on the factory fuel pump housing until it clicks and locks in place.



14. Route this hose along the floor, under the rear upper seat cushion, to the fuel surge tank.

Connect to any of the ports on the top of the surge tank that are black, as shown.

Important: Do not connect this hose to the green fuel pump outlet fitting. The black fittings all have the exact same function and are interchangeable.



15. Locate the hose that is 41.5" long and has a 90 degree and a straight hose end fitting. Install the male quick-connect adapter into the straight hose end.

Connect this hose to the quick connect fuel line, as shown, and reinstall the green retaining clip.

Route the hose into a half loop before exiting the fuel pump cover to give it some slack. Connect the 90 degree hose end to the green fuel pump outlet fitting on top of the FST.

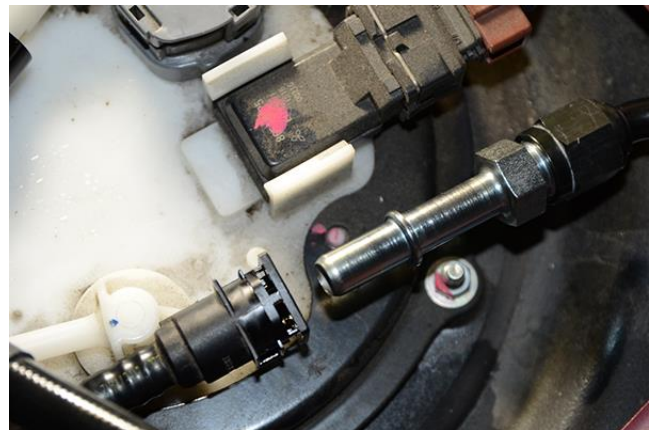

16. Install the included -6AN to hose barb adapter into the OEM fuel return hose, as shown. Re-use the spring clamp.

Locate the PTFE hose in the kit that is 45" long with a straight and 180 degree hose end. Screw the straight end onto the aforementioned -6AN adapter fitting, as shown.

Route this hose to one of the remaining black port fittings on the fuel surge tank.



17. Locate the ¼" non-permeating rubber hose, 2 hose clamps, and the other -6AN to barb adapter in the kit.

Insert the hose on the barb and secure with a hose clamp. Place the other clamp on the opposite side, as shown.

Slide the other end onto the fuel return fitting on the fuel pump housing and secure with the hose clamp.

Note: This hose can be trimmed accordingly to improve hose routing after installation commences.



18. Locate the last remaining hose in the kit which should be 39" long with 45 degree and 180 degree hose ends.

Secure the 45 degree hose end to the -6AN male to barb adapter fitting from the previous step, as shown.

Route this PTFE hose to the last remaining port on the fuel surge tank.



19. With the four hoses routed, test fit the cover as shown.

For best hose routing, it may be necessary to rotate the FST on its mount by removing the screws holding it to the mounting bracket.

Once optimal hose routing is in place, secure all mounting bolts and screws for the FST bracket.



20. Make four marks on the cover where a passage for each hose will need to be cut.

Cut out each passage using any tool capable of cutting thin sheet metal. The cleaner the cuts, the easier it will be to re-seal the cover.

Do not permanently install cover yet.



21a. For EVOX FST install kits purchased before May 2016, use the included cushion clamps to secure the hoses in place.

Make sure that clamps will not interfere with lower seat cushion placement.

To secure the clamps, use the self-tapping sheet metal screws and an electric drill driver.



21b. EVOX FST install kits purchased after May 2016 come with a 5-Way Separator Clamp (Radium 20-0231), replacing the previously mentioned cushion clamps.

Swap out 2 of the 4 bolts with the 2 included self-tapping sheet metal screws. To secure the clamp to the chassis, use an electric drill driver.

NOTE: the 5<sup>th</sup> hole can be used for wires.

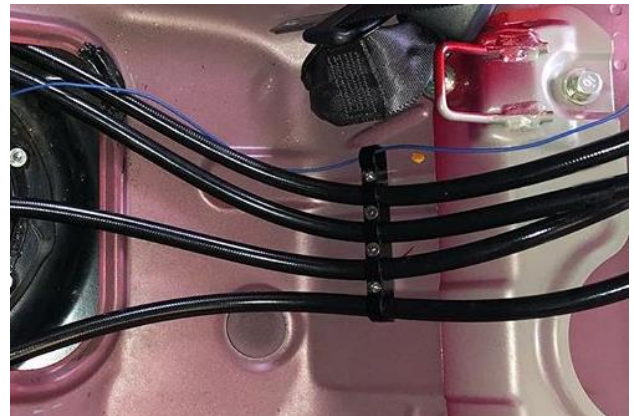

22. Use this schematic as a guide to make the proper connections using the parts supplied in the kit. The center wire in the relay (terminal 87a) is not used, so the wire can be removed from the connector, or it can be cut short and left installed. Extend the blue relay wire using the included small heat shrink butt connector and spare blue wire.

Note: For the included butt connectors, only a heat gun is necessary. No solder or crimping is needed.

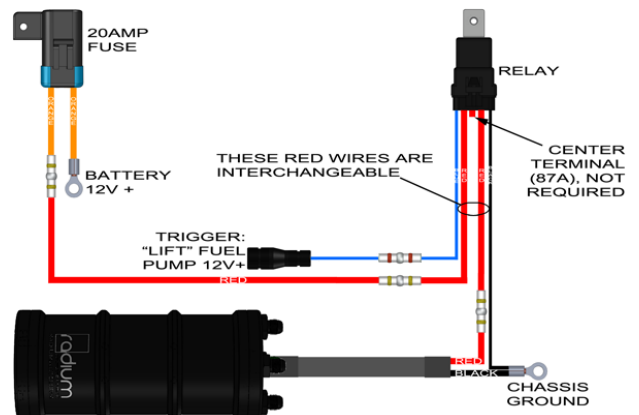

23. Locate the Posi-Tap connector in the kit. Install it on the blue wire on the fuel pump power connector, as shown. Run the extended blue wire from the relay to this connector. Strip a small section off the end of the wire and insert into the Posi-Tap connector. Next, tighten the plastic nut.

Reinstall the fuel pump cover. To help seal around the hoses where they pass through the fuel cover, an adhesive strip caulking may be used such as 3M P/N: 08578.



24. Battery power +12V can be found at the positive battery terminal.

Use the included wire and ring terminal and run a wire from the positive battery terminal to the one of the fuse leads.

Use the included solder butt connectors to make the proper connections.

Cut wire to length.



25. For the chassis ground connection, use the location where the negative battery cable attaches to the trunk floor.

Remove the M8 bolt and install a black wire with a ring terminal. This wire will connect to the surge tank negative wire (black) and the black wire from the relay.



26. Plug the relay connector into the relay. Confirm there is a fuse installed for the FST pump and plug it back into the fuse holder. Double check all connections. Reconnect the negative battery terminal and turn the key to the ON position. This will activate the priming cycle on the OEM fuel pump. This should also trigger the FST relay and turn on the pump inside the FST. If this does not happen, re-check the wiring. Cycle the ignition power several more times to fill the FST. Check for leaks at all connections. Correct any leaks.

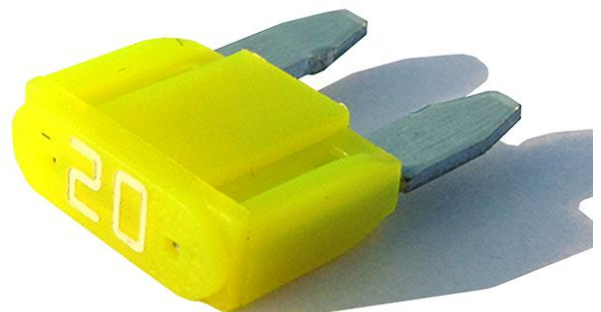

27. Start the engine. It may take longer than usual due to air pockets being bled out of the system.

Note: Due to the restrictive return port on the OEM fuel pump housing, a slightly higher static fuel pressure is normal when using a high flow pump. The best way to alleviate the issue is to purchase a Radium Engineering EVOX fuel hanger. Included is a higher flowing venturi siphon jet pump.

Reinstall trunk paneling and rear seats. Installation complete.

