

Splined Stub & Sleeve Kit

Part No.

T35-125-400-KIT

- Yoke/Stub Shaft
- Splined Sleeve
- Boot
- Boot Clamps (2)

NOTE: For use with .125" wall thickness aluminum tubing.

Fits 1350 U-Joint, 4" Dia. Tubing



1. Install slip spline assembly into mating driveshaft tube.
2. Measure runout of assembled shaft, adjust if necessary and weld in accordance with standard build procedures.
3. Balance shaft in accordance with standard build procedures.
4. Separate yoke shaft from splined sleeve.
5. Apply a light, even coating of grease to yoke shaft splines. The following greases are recommended:
 - TriboGel® PA6110LCS synthetic grease
 - Chevron® Ultra-Duty EP-2 grease (NLGI Grade 2)
 - Spicer® 232799 Ultra-Duty EPS Multi-Purpose grease
6. Reinstall yoke shaft in splined sleeve, along with the protective boot included with the kit, taking care to ensure the phasing witness marks on yoke shaft and sleeve are aligned (**Figure 1**).

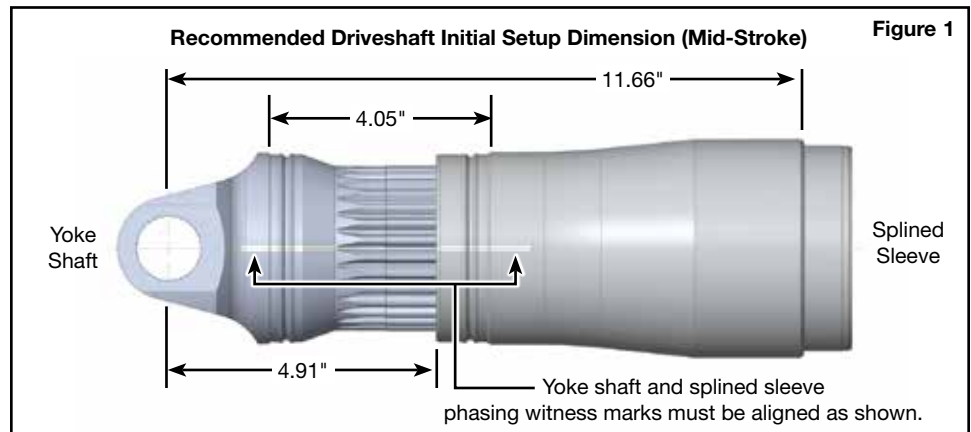

7. Recommended installation setup length and minimum/maximum operating lengths:
- The recommended installation setup length (mid-stroke) is 4.05" (**Figure 1**).
 - The recommended minimum collapsed operating length is 3.30" (**Figure 2**).
 - The recommended maximum extended operating length is 4.80" (**Figure 3**).

