

TRANS^{GO}

REPROGRAMMED AUTOMATIC

1973-77

Cast Iron Case Cruise-O-Matic

TOOLS RECOMMENDED FOR EASIEST, QUICKEST INSTALLATION

SPEED HANDLE OR RATCHET

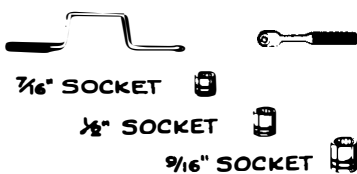

SCREW DRIVER



3/16" WRENCH

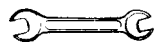

VACUUM MODULATOR WRENCH OR WATER PUMP PLIERS



CRESCENT WRENCH

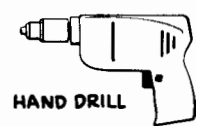

HAND DRILL

This Trans-GO Kit was a very intelligent decision. Your transmission will love you for it. This kit transforms a good working "stock" automatic transmission into a rugged, responsive, hi-performance unit.

A Trans-GO Kit will more than double the life of your transmission under high load conditions. There's no reason to lose precious efficiency with soft shifts that generate heat and consume horsepower.

Trans-GO brings automatic transmission performance out of the dark ages into the space age, in one giant step. Installed in your transmission, a Trans-GO Kit recalibrates it to hi-performance specifications. It controls shift timing and "shift feel" for instant response and racing performance.

Cleanliness is important. An ideal place for valve body work is a clean table or work bench free of any other parts or springs. A piece of cardboard makes an excellent working surface once the valve body has been drained of transmission fluid.

Now you are ready to throw a shift that will make the 4 Speeders Jealous!

This Kit fits '73 - '75 passenger cars with dual diaphragm modulator. It also fits '73 & '74 F-350-600 trucks with single diaphragm modulator.

STEP 1

Loosen oil pan and drain oil. If filler tube screws into pan, remove it. If fluid is to be reused it should be drained into a clean container.

STEP 2

Disconnect vacuum hoses from the vacuum modulator located on left rear corner of transmission case. Unscrew vacuum modulator and remove it and push rod. (See Photo No. 2A) Use thin 3/4" wrench, water pump pliers or pipe wrench.

STEP 3

The transmission oil screen is held in place with a metal clip, notice how it is installed. Remove clip and oil screen.

PHOTO NO. 2A

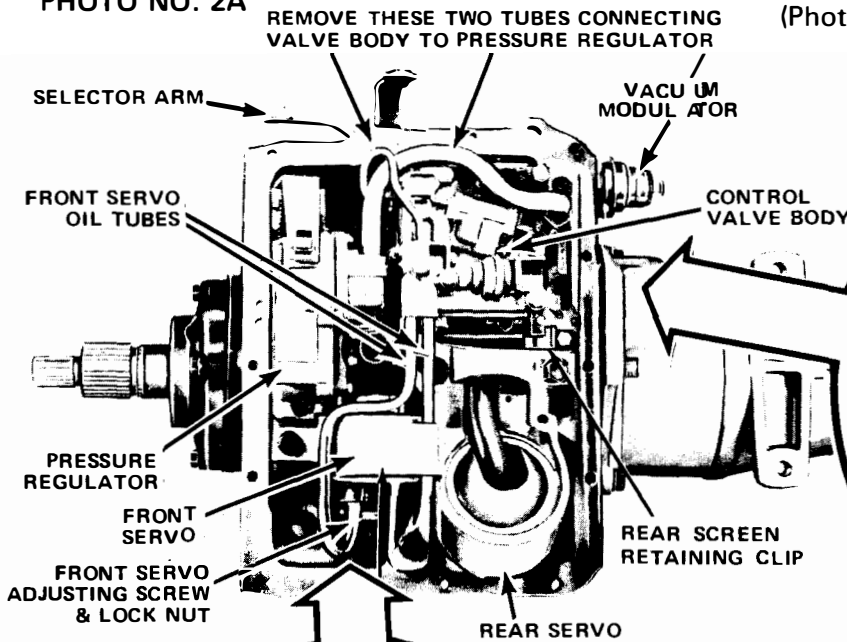

REMOVE THESE TWO TUBES CONNECTING VALVE BODY TO PRESSURE REGULATOR

PHOTO NO. 2C

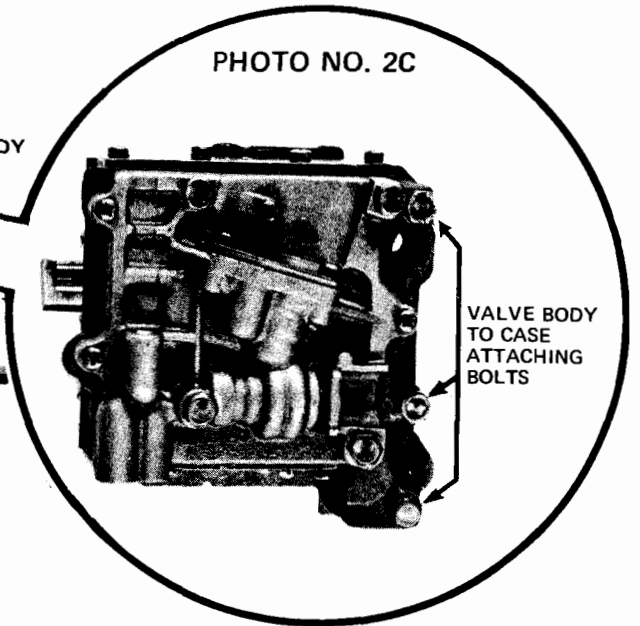

VALVE BODY TO CASE ATTACHING BOLTS

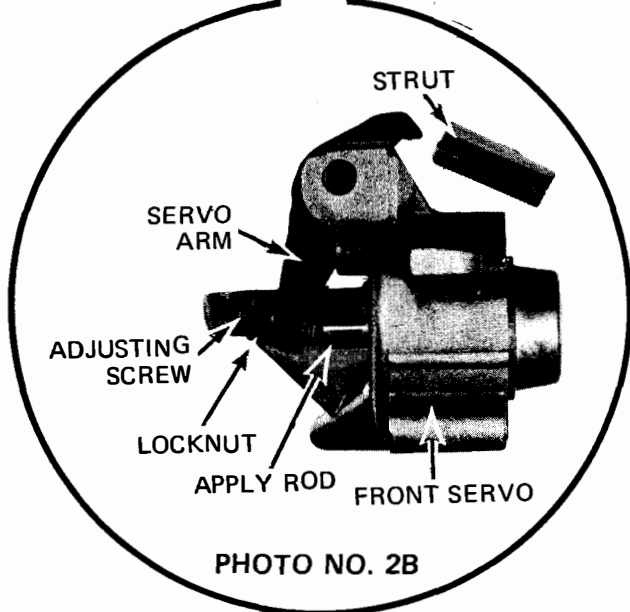

PHOTO NO. 2B

STEP 4

Remove the two tubes connecting valve body to pressure regulator. To remove big tube, unplug at valve body first. Be very careful, do not bend or distort tubes. (See Photo No. 2A)

STEP 5

If you are installing a 33-1 Kit, go directly to Step 8. If you are installing a 33-2 Kit, continue as follows:

Loosen locknut on front servo adjusting screw and back screw out until the servo arm touches the apply rod. (See Photo No. 2B)

STEP 6

Remove both front servo attaching bolts (use 9/16 socket) (some servos have only one bolt) and the three bolts attaching valve body to case (use 7/16 socket). Remove valve body and front servo together. Watch for band apply strut, it connects servo arm to the front band and will probably fall out when servo is removed. Band anchor strut (Photo No. 2D) may also fall out.

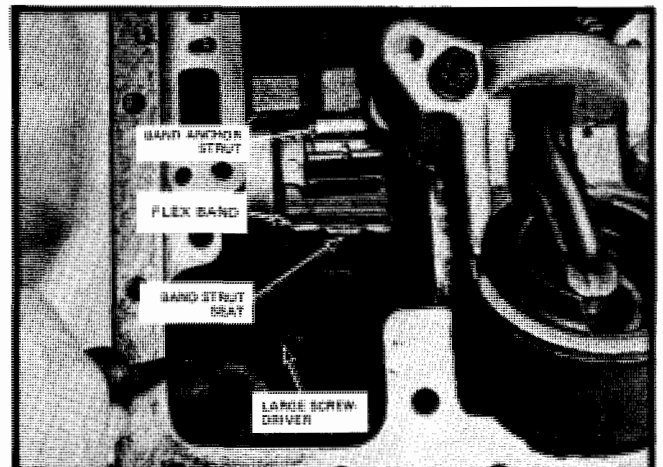
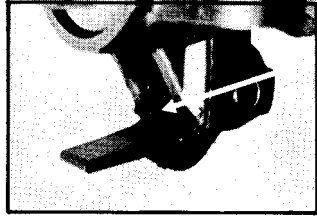

PHOTO NO. 2D

STEP 7

Remove two tubes between servo and valve body. Install new servo parts as shown. (See Photo No. 3A)



USE THICK GREASE TO HOLD STRUT IN PLACE

NEW "O" RINGS FURNISHED IN KIT

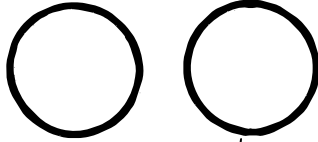

SERVO APPLY ARM THICK END BAND APPLY STRUT

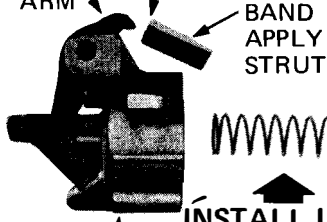

INSTALL LARGE BLACK SPRING HERE

Special TransGO high volume Servo Cover, Piston and Spring. (Furnished In Competition Kit Only)

PHOTO NO. 3A

Install thick end of strut into band apply arm (Photo No. 3A). Use thick grease to hold it in position. While installing servo onto case, slide thin end of strut into strut seat on band.

If you have flex band as shown in Photo No. 2D, see that anchor strut is in position and hold band with screwdriver as servo is installed.

STEP 8 VALVE BODY

PHOTO NO. 3B

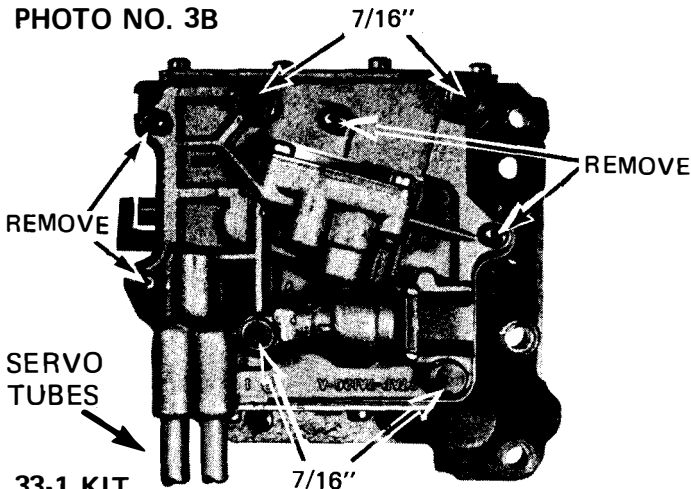

33-1 KIT

Remove four bolts (use 7/16" socket) and four screws that attach valve body cover. (See Photo No. 3B) Slide valve body cover off servo tubes. Remove small separator plate with cover. Remove three bolts attaching valve body to case (use 7/16" socket and remove valve body. (See Photo No. 2C)

33-2 KIT

Remove four bolts (use 7/16" socket) and four screws that attach valve body cover. (See Photo No. 3B)

STEP 9

LOWER VALVE BODY

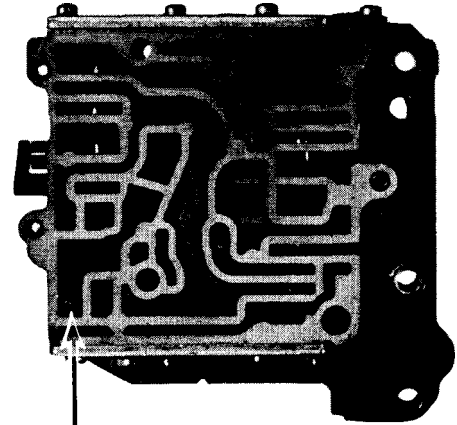

DISCARD CHECK BALL IF YOUR VALVE BODY HAS ONE AT THIS LOCATION (DO NOT REINSTALL)

STEP 10

Remove and discard spring and ball from cover as shown in Photo No. 3D.

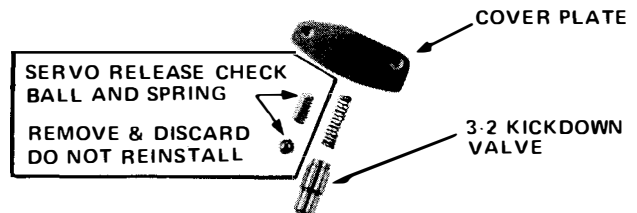
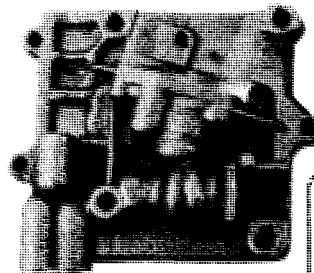

PHOTO NO. 3D



1-2 SHIFT ACCUMULATOR VALVE & SPRING

DO NOT DISASSEMBLE

VALVE BODY COVER

THROTTLE VALVE BODY REMOVE

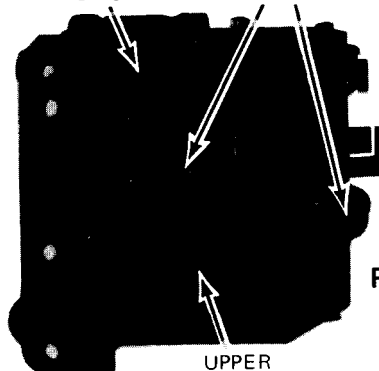

UPPER VALVE BODY

STEP 11

Remove two screws attaching upper valve body to main valve body. (See Photo No. 3E)

PHOTO NO. 3E

LOWER VALVE BODY

LOWER VALVE BODY

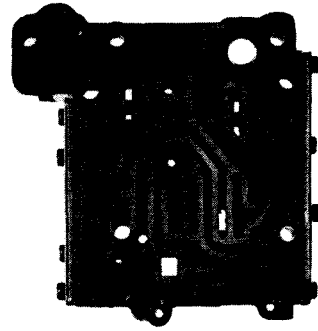
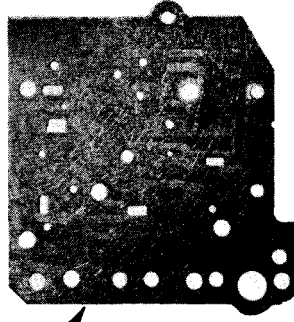
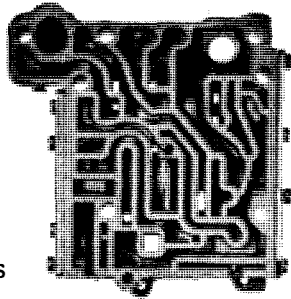

STEP 12

Remove two screws attaching separator plate to upper valve body. (See Photo No. 4A)

REMOVE

PHOTO NO. 4A

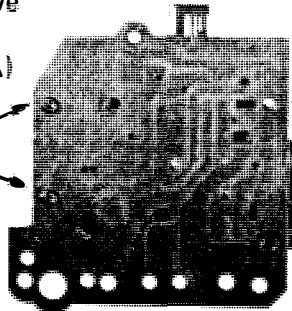

UPPER VALVE BODY

LARGE SEPARATOR PLATE

PHOTO NO. 4B

STEP 13

Watch for check ball as you lift large separator plate from upper valve body. (See Photo No. 4B)

CHECK BALL REMOVE NOW REINSTALL LATER

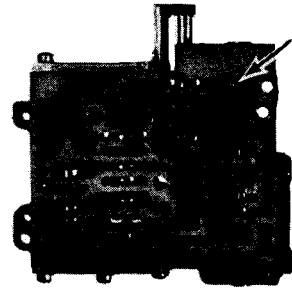

UPPER VALVE BODY



ENLARGE THIS HOLE WITH DRILL FURNISHED IN KIT

STEP 14

Enlarge hole in separator plate as shown with drill furnished (See Photo No. 4C).

PHOTO NO. 4C

STEP 15

Install new valve and springs in upper valve body, discard old parts they replace. (See Photo No. 4D)

UPPER VALVE BODY

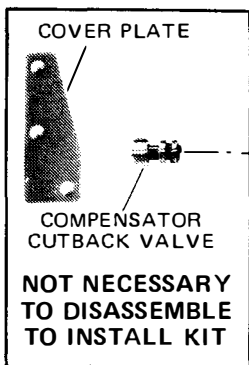

COVER PLATE

COMPENSATOR CUTBACK VALVE

NOT NECESSARY TO DISASSEMBLE TO INSTALL KIT

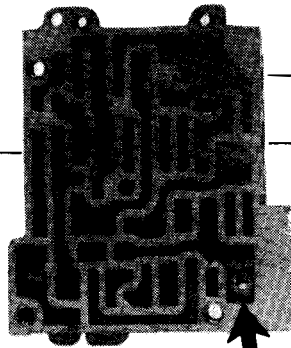

3/16" BALL HERE

INSTALL SMALL BLACK SPRING HERE



THRITTLE BOOST

Compare small land of new Compensator Valve with original valve, if land on new valve is larger, you have a 1972 type valve body. (Use 1972 Kit)

INSTALL BLUE SPRING HERE

INSTALL SMALL GREEN SPRING HERE

REPLACE WITH NEW COMPENSATOR VALVE

LEVER STOP BRACKET

DOWNSHIFT VALVE

MANUAL VALVE

PHOTO NO. 4D

STEP 16

Install new springs in lower valve body and discard old springs. Remove transition spring as shown in Photo No. 5A.

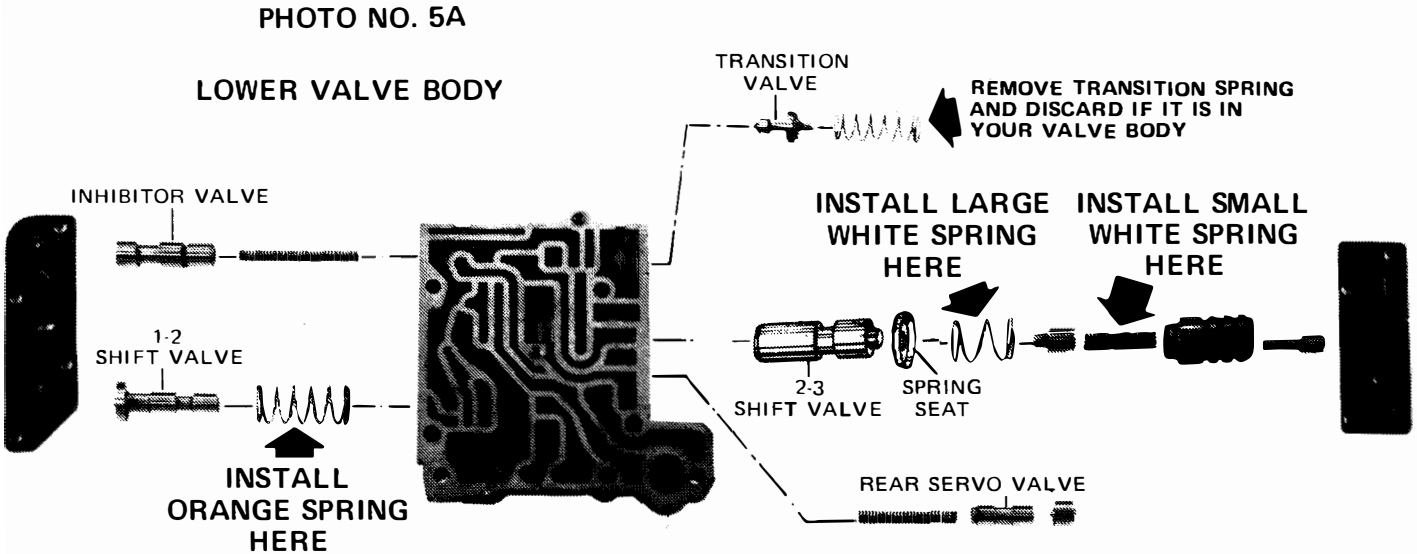

STEP 17 VALVE BODY REASSEMBLY

Install check ball in upper valve body as shown in Photo No. 4B. Install large separator plate onto upper valve body as shown in Photo No. 4A.

Install upper valve body onto lower valve body. **DO NOT INSTALL THE REMAINING SMALL SEPARATOR PLATE AND VALVE BODY COVER AT THIS TIME.**

STEP 18

Place valve body onto transmission case and start the three attaching bolts shown in Photo No. 2A. *Do not tighten them now.*

Make sure pin in selector arm is between the two spools on end of manual valve. The kickdown lever beside it must be between downshift valve and lever stop bracket. When arm on outside of case is moved by hand the lever must push against downshift valve.

STEP 19

Place small separator plate on cover, slip cover onto servo tubes and install the 4 screws and 4 1/4" bolts and tighten them.

DO NOT OVERTIGHTEN BOLTS OR SCREWS.

STEP 20

Install the two tubes between valve body and pressure regulator. Insert the big tube first into pressure regulator then push it into valve body, wiggle valve body to make installation easier. To install small tube it may be necessary to tap lightly with small hammer or screwdriver handle.

STEP 21

Tighten the three valve body attaching bolts and the front servo bolts.

VALVE BODY BOLTS – 80 inch pounds (Firm one hand pressure with speed wrench.)

SERVO BOLTS – 25 foot pounds (Firm with ratchet wrench.)

STEP 22

Install new **YELLOW** pressure regulator spring, use original spring seat. (See Photo No. 6A)

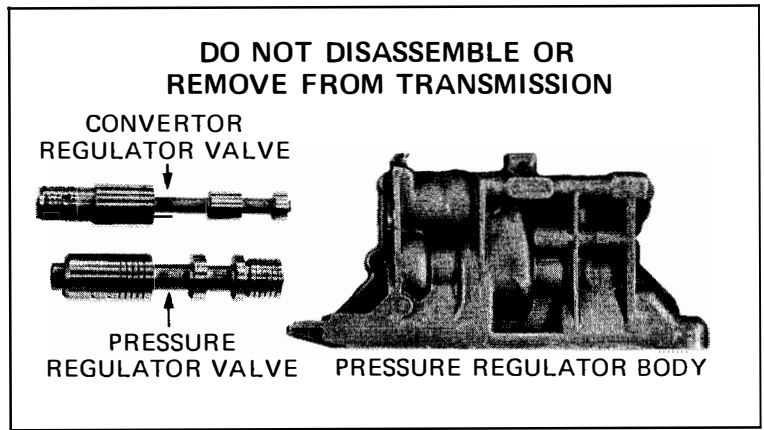
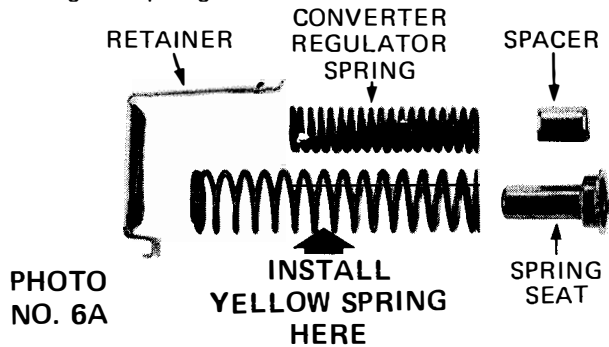

ATTENTION: LATE 74's HAVE A SINGLE SPRING TYPE REGULATOR ASSEMBLY. DO NOT INSTALL YELLOW SPRING. RE-USE ORIGINAL SPRING.

STEP 23

With Lock Nut loose, turn Adjusting Screw until 1/4" bolt will just pass between Servo Apply Rod and the end of Adjusting Screw with slight drag. (See figure No. 6B) Then turn Adjusting Screw "IN" (Clockwise) one (1) Turn and tighten Lock Nut.

(Use 1/4" bolt from valve body or any bolt that a 7/16" wrench will fit.)

1/4" bolt being inserted between Servo Rod and Band Adjusting Screw.

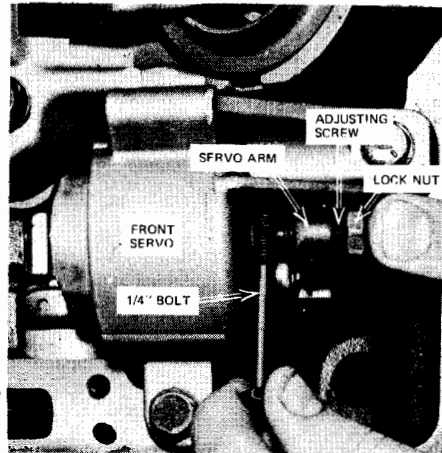

PHOTO NO. 6B

Pull back on Servo Apply Lever until all slack is removed from Band Apply Linkage

STEP 24

Wash oil pickup screen and install using metal retainer.

STEP 25

Install new thin gasket onto vacuum modulator. Place your original push rod into modulator and install onto transmission. If you have installed Holley carb or if your exhaust gas recirculator has been disconnected, do not install hose to front tube on modulator.

STEP 26

Clean transmission oil pan, remove old gasket, install pan using new gasket, connect filler tube.

STEP 27

Pour three (3) quarts of fluid into transmission. Start engine with selector in "P" (PARK) and add fluid until level is at full mark on dipstick.

PERFORMANCE

We recommend using Ford "F" fluid in this transmission. It works just fine.

Only **TRANSO** exclusive reprogramming gives you everything.

PERFORMANCE: Positive upshifts and downshifts at your finger tips for maximum performance.

CONVENIENCE: Automatic shifts in "D" position.

SAFETY: Manual downshifts to 2nd at any speed and to 1st at 40-50 mph. depending on carburetor, etc.

We do not recommend any special fluid. Most of these "special" fluids lack some lubricating qualities, and can shorten the life of bushings, bearings, pumps and thrust washers.

STEP 28 ROAD TESTING

Drive approximately two miles easy before attempting high throttle up-shifts. During this two miles move shift lever to all forward positions a dozen or more times. Check oil level and add oil if necessary. *Do not run above full mark.*

STEP 29 PERFORMANCE TUNING

If shifts are too early, E.G.R. System may be plugged, disconnected or malfunctioning (dual Diaphragm models). Disconnect front hose at modulator, plug hose with a 1/4" bolt and road test. If shifts are O.K., E.G.R. must be repaired or bolt must be left in line and front tube on modulator left open.

If shifts are late or too firm, remove modulator and install thick gasket furnished along with standard gasket.

If later or firmer shifts are desired, install push rod furnished with thin gasket.