

# IMF89



## 2023+ TOYOTA GR COROLLA MUD FLAP INSTALLATION INSTRUCTIONS

















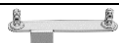

Manufacturer warranty covers material defects on new, never installed parts. Once installed, all mud flap replacement part costs are the responsibility of the vehicle owner. Caution against blind spots during parking. Avoid curbs and excessive compression to the flaps. Check stock and aftermarket wheel/suspension clearances.

**INSTALLATION QUESTION? FOR REPLACEMENT PART QUOTES, SEND FLAP RECEIPT OR PHOTO → [www.rallyarmor.com/support](http://www.rallyarmor.com/support)**

Recommended Tools 7/16<sup>th</sup> Wrench, Phillips screwdriver, flat screwdriver.

Install on even surface using hand tools, not powered tools. **AVOID OVERTIGHTENING HARDWARE. TIGHTEN ONLY UNTIL WASHERS SEAT AGAINST MUD FLAP.**

**ABOUT OUR STANDARD IN MUD FLAPS** Polyurethane is a high grade plastic that may feature minor surface layer marks. These are visual variations that don't affect flap construction or performance. Most matte away as the material ages naturally.

MF89 KIT CONTENTS CONFIRM ALL PARTS AND QUANTITIES BEFORE INSTALLATION		
MUD FLAP PN: MF89 SEE PAGE 4	PART DESCRIPTION	QUANTITY
MF89-LF	LEFT FRONT	1
MF89-RF	RIGHT FRONT	1
MF89-LR	LEFT REAR	1
MF89-RR	RIGHT REAR	1
<b>BRACKET PN: BMF89</b>		
BMF67 	BRACKET FRONT	2
BMF67-RE 	BRACKET FRONT 2	2
BMF89-LR 	BRACKET LEFT REAR	1
BMF89-RR 	BRACKET RIGHT REAR	1
BMF92-LR 	BRACKET LEFT REAR 2	1
BMF92-RR 	BRACKET RIGHT REAR 2	1
<b>HARDWARE PN: HMF89</b>		
.25SP 	SPACER	2
1.5SS 	LONG SCREW	2
1SS 	SCREW	6
1SS#8 	THIN SCREW	2
EXPANCH 	ANCHOR	2
SMF29-1 	FOAM SPACER	2
SMF29-2 	FOAM SPACER 2	2
SMWASH 	WASHER	22
SSLNUT 	NUT	14
UNUT 	CLIP	6

## 2023+ TOYOTA GR COROLLA MUD FLAP INSTALLATION INSTRUCTIONS

### FRONT MUD FLAP

To access interior wheel well, turn steering wheel towards installation side.

Bracket/Hardware for 1 Flap → 1 x BMF67; BMF67-RE; 1 x .25SP; 2 x 1SS; 1 x 1.5SS; 1 x SMF29-1; 4 x SMWASH; 1 x SSLNUT

Do not fully tighten fasteners until mud flap is completely aligned to vehicle.

**FIGURE A** Remove factory fasteners 2 & 3. Located underneath vehicle, uninstall fastener 4.

**FIGURE B** Place .25SP & BMF67-RE over mount 4, then install using 1SS.

**FIGURE C** Adhere SMF29-1 to mount 2.

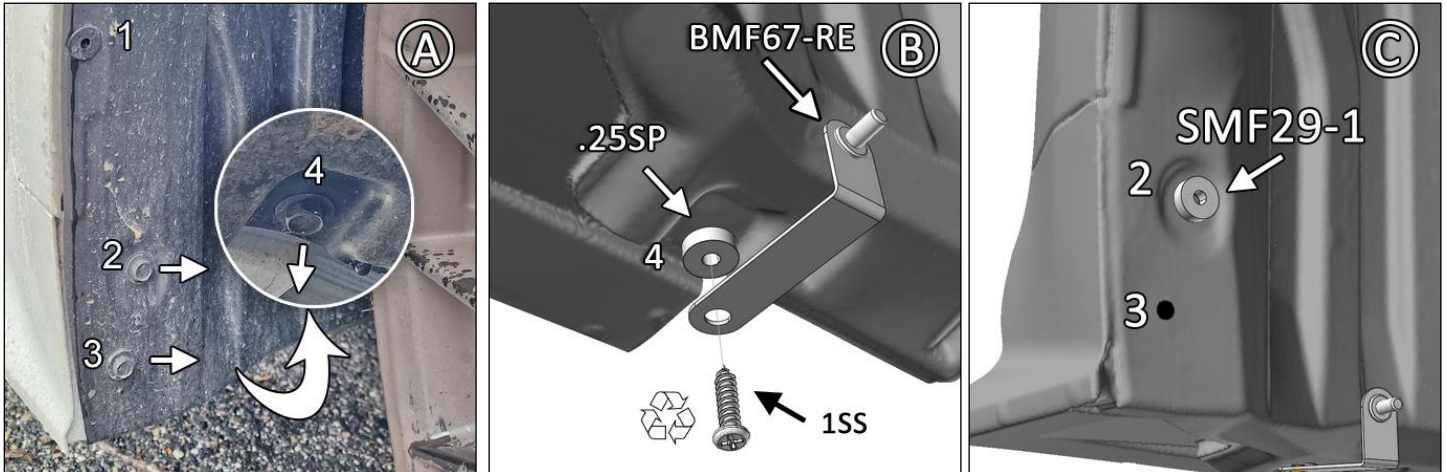

**FIGURE D** Place logo-side of flap facing rear bumper, against mounting points. Install SMWASH & SSLNUT into mount 5.

**FIGURE E** Place BMF67 over flap. Install SMWASH & 1SS into mounts 1 & 3 and SMWASH & 1.5SS into mount 2.

**FIGURE F** Align flaps to even ground, adjusting preferred width before tightening fasteners until washers are just seated.

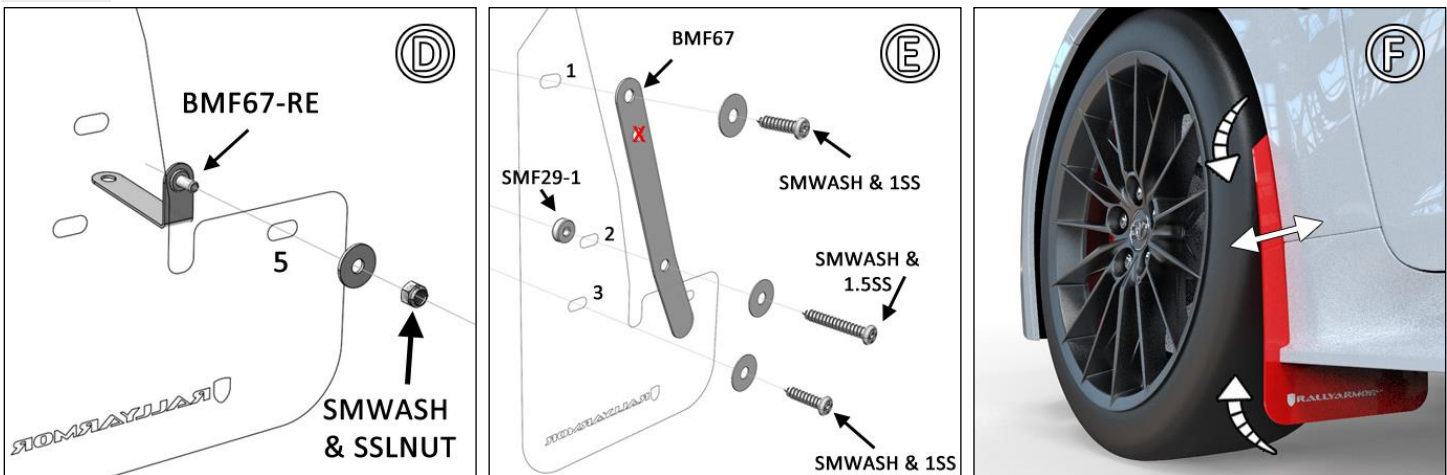

### REAR MUD FLAP

Do not fully tighten fasteners until mud flap is completely aligned to vehicle.

Bracket/Hardware for 1 Flap → 1 x BMF89-LR/RR; 1 x BMF92-LR/RR; 1 x 1SS#8; 1 x EXPANCH; 1 x SMF29-2; 7 x SMWASH; 6 x SSLNUT  
3 x UNUT

**FIGURE G** Temporarily remove liner from rear bumper.

**FIGURE H** Subtly curve BMF89-LR/RR, about 3-5mm, shaping it to nest against liner.

**FIGURE I** Install factory fastener into BMF89-LR/RR and liner mount 5.

**2023+ TOYOTA GR COROLLA MUD FLAP INSTALLATION INSTRUCTIONS**



**FIGURE J/K** Align top-end tab 1 of BMF89-LR/RR to edge of liner before securing UNUT over it. Fasten UNUT over tabs 2 & 3.

**FIGURE L/M** Adhere SMF29-2 onto flat side of BMF92-LR/RR before placing it over liner mount 6.

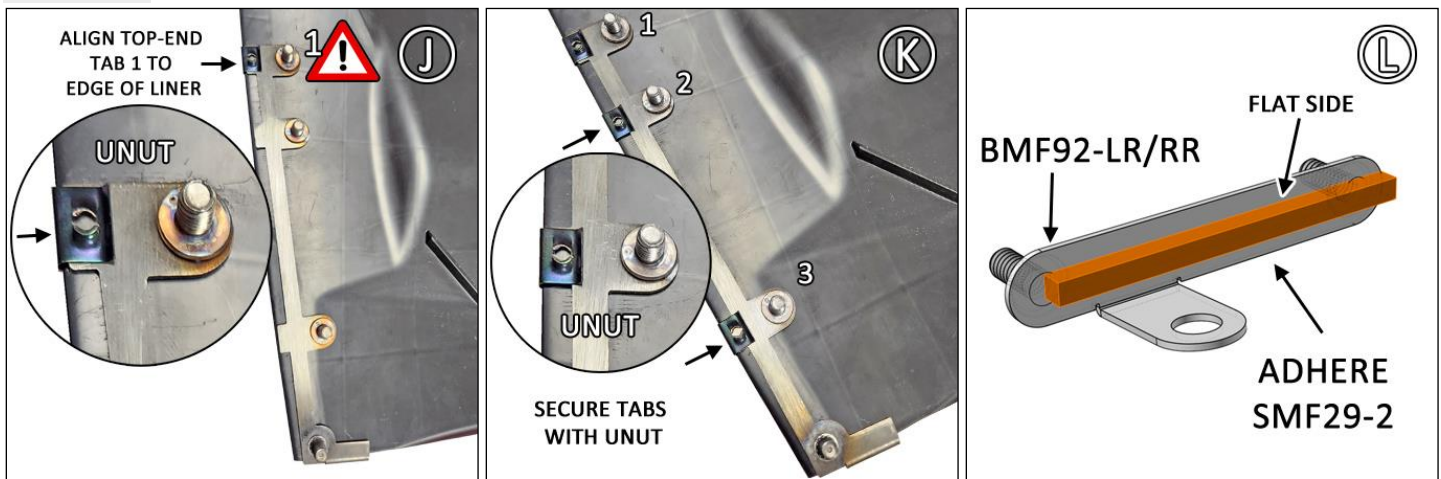

**FIGURE N** Fold EXPANCH then install through BMF92-LR/RR & mount 6. Expand EXPANCH stem before fastening SMWASH & 1SS#8.

**FIGURE O** Use factory fasteners to reinstall liner.

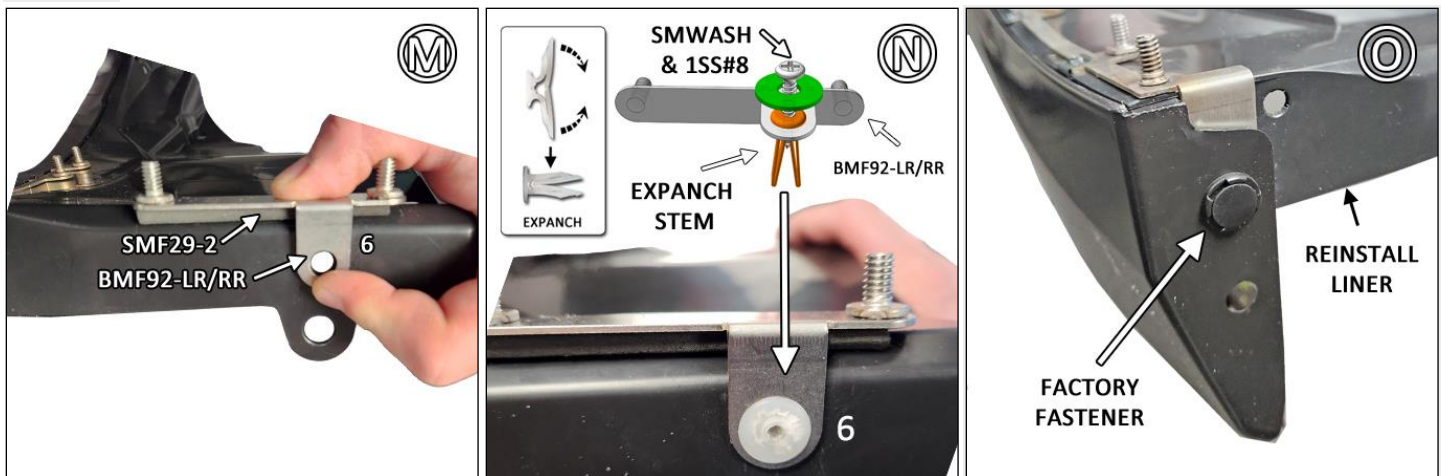

**FIGURE P/Q** Install SMWASH & SSLNUT to mounts 1 – 4, 7 & 8.

**FIGURE R** Align flaps to even ground, adjusting preferred width before tightening fasteners until washers are just seated.



# IMF89



## 2023+ TOYOTA GR COROLLA MUD FLAP INSTALLATION INSTRUCTIONS

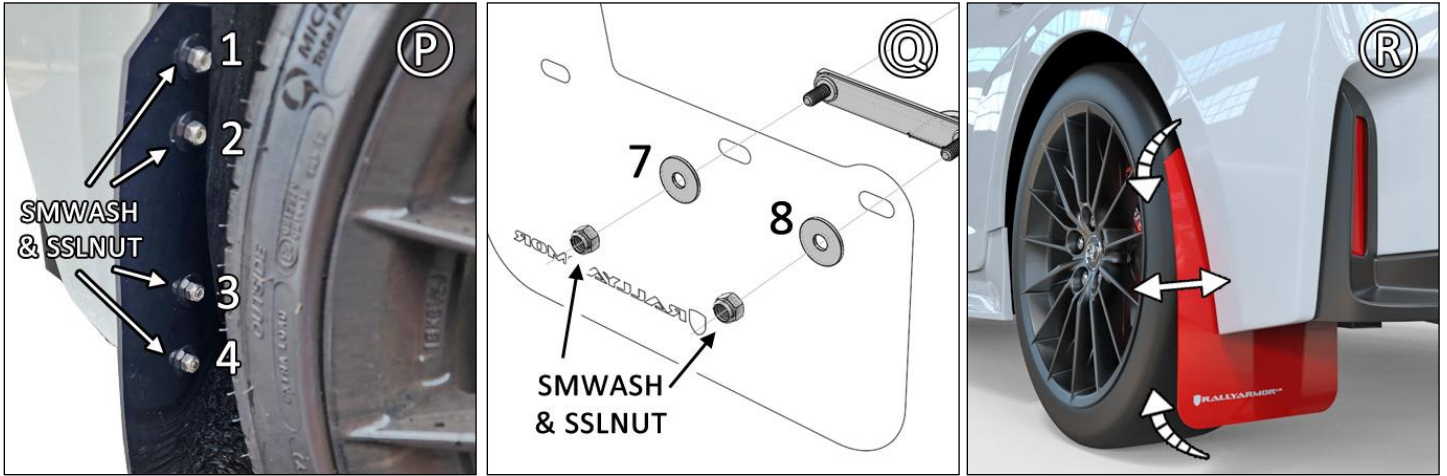

FRONT

REAR

