

Installation Instructions

I - Sheet Number BF70 Rev.A



AUTO VENT SHADE™

Bugflector® - Bugflector II® - Carflector™

For proper installation and best possible fit, please read all instructions BEFORE you begin.
For technical assistance or to obtain missing parts, please call Customer Relations at 1-800-241-7219.

Important Safety Information



- CAUTION - Before driving, ensure that the hood shield is properly anchored to vehicle.
- Do not use automatic "brush-style" car washes.
- Do not use cleaning solvents of any kind.
- Periodically check all components for tightness.

Contents **NOTE:** Actual product may vary from illustration.



Hood shield



Fastener x2



Bump On x4

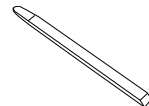

Pry Tool x1

Tools Required



Car Wash Supplies

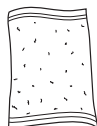

Clean Towel

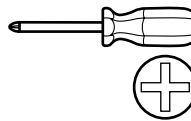

Phillips screw-
driver

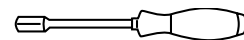

10mm Nut
Driver

Preparation Before Painting / Installation

- A trial fit is recommended to ensure proper positioning and fit.
- Check fit of parts before painting as we will not accept the return of modified or painted parts.
- Wash and dry your vehicle to remove any debris and/or dirt from the installation area.

Installation Steps **NOTE:** Actual application may vary slightly from illustrations.

Locate the plastic applique on the grill.

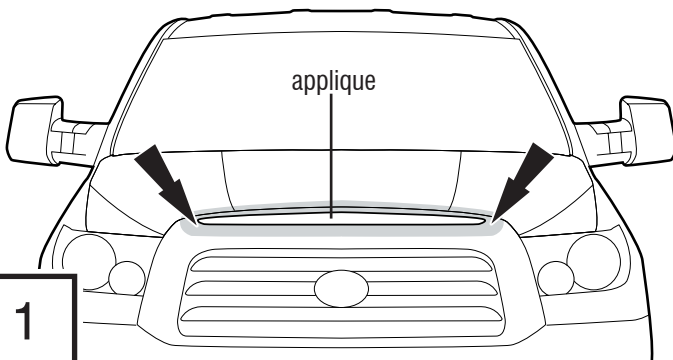

1



Using the Pry Tool provided, carefully pry the plastic applique away from the grill. Begin by lifting up the bottom drivers side corner and work your way across to the bottom passenger side corner. Remove applique.

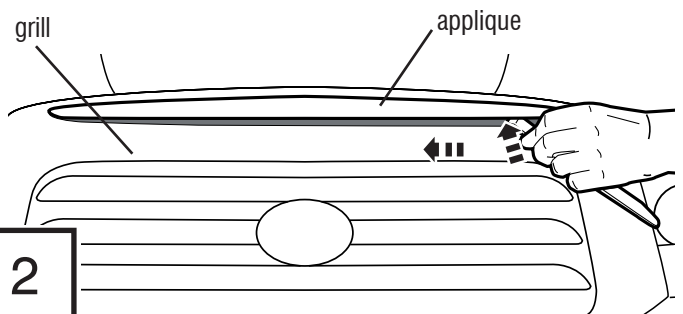

2

Installation Steps

NOTE: Actual application may vary slightly from illustrations.



With the applique removed, use a 10mm nut driver to remove the (5) exposed bolts.

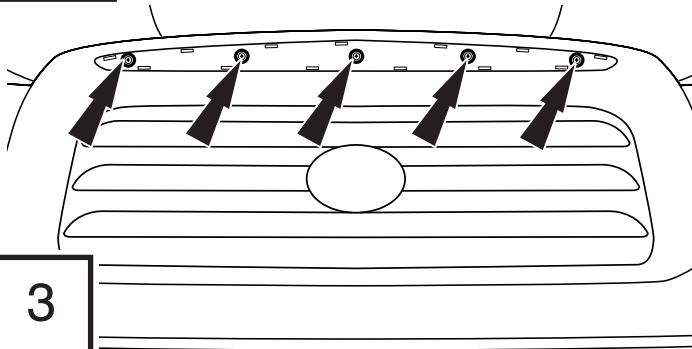

3

Carefully raise hood.

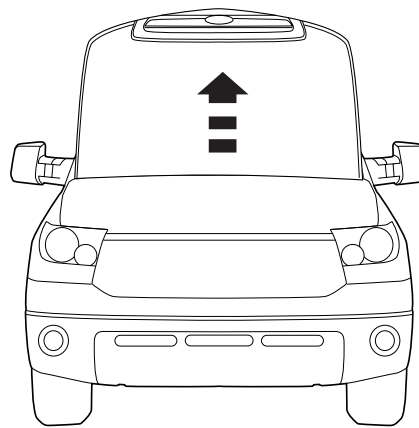

4

Reach under the hood to the backside of the grill and disconnect the hood lock rod from the grill by releasing the lock mechanism and gently lifting the rod away from grill.

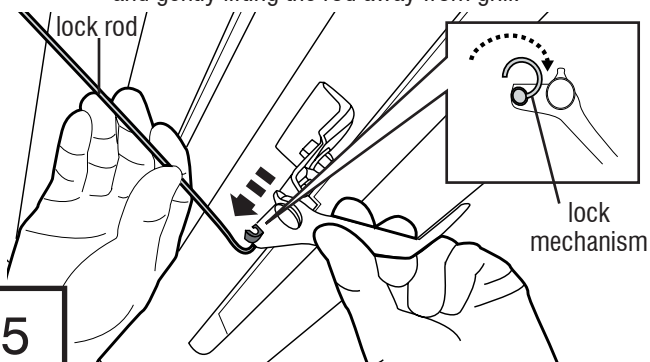

5



Reach under the hood to the backside of the grill, and using a nut driver remove (10) nuts.

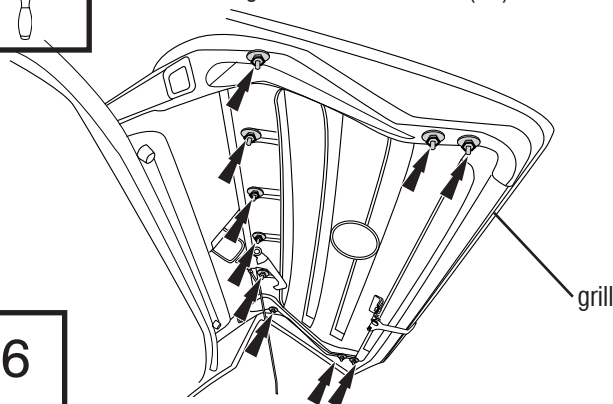

6

Carefully lower hood.

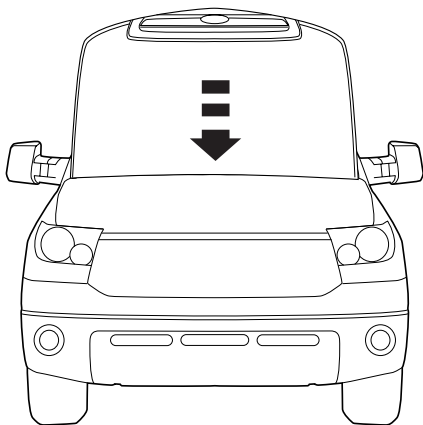

7



Starting on the driver side top corner of the grill, and then the passenger side, use the Pry Tool provided to carefully pry the grill loose from the hood. Set grill aside.

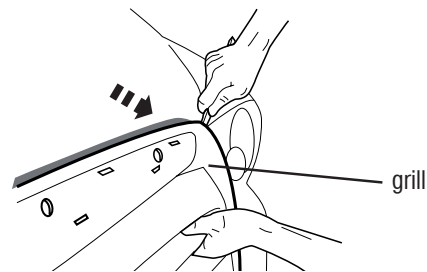

8

NOTE: The grill will make a "popping" noise as it separates from the vehicle. This is normal.



Clean front of hood edge, and carefully raise hood.

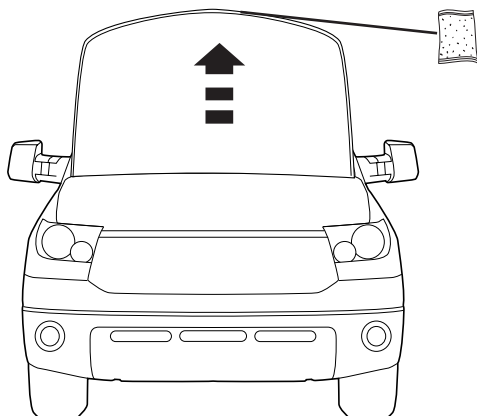

9

Align hood shield with hood edge.

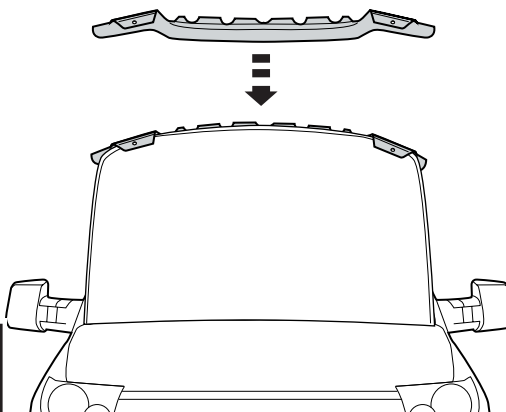

10

Installation Steps

NOTE: Actual application may vary slightly from illustrations.

Align (2) holes in hood shield with holes in hood.
Install a fastener in each hole.

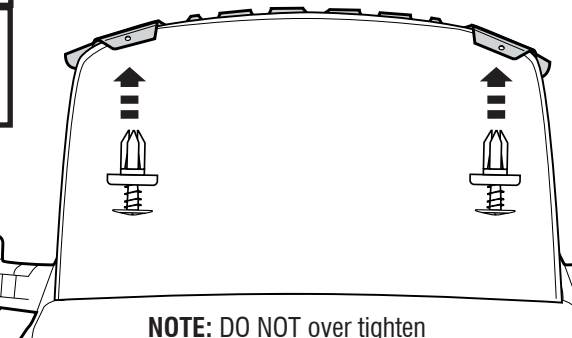

NOTE: DO NOT over tighten

11

This panel shows the installation of the hood shield. It includes two small inset icons: a bolt and a screwdriver. The main diagram shows a top-down view of the hood shield being aligned with two holes on the hood. Arrows point to the alignment points, and two bolts are shown being inserted into the holes. A note at the bottom of the diagram reads 'NOTE: DO NOT over tighten'. The number '11' is in a box at the bottom left.

Carefully lower hood.

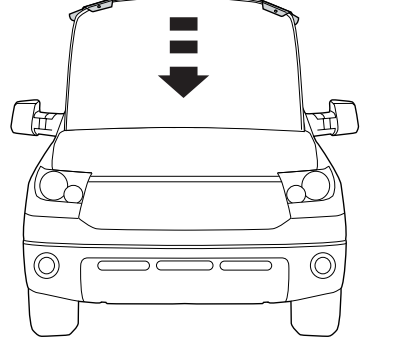

12

This panel shows the hood being lowered. A top-down view of the car's front end is shown with a large downward-pointing arrow above the hood, indicating the direction of movement. The number '12' is in a box at the bottom left.

Reinstall grill by aligning with holes in hood edge. Ensure that the hood shield is **BETWEEN** the grill and the hood.

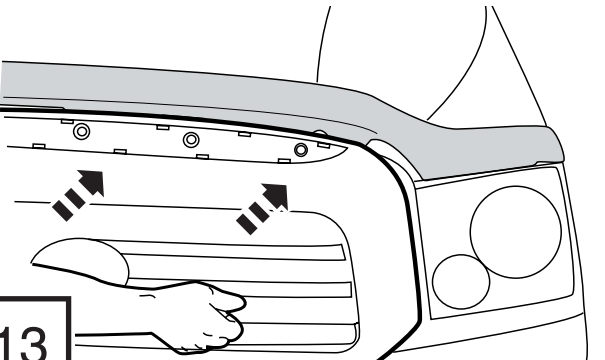

13

This panel shows the grill being reinstalled. A side view of the front of the car is shown. A hand is shown pushing the grill into place. Arrows indicate the direction of movement. The text above the diagram says 'Reinstall grill by aligning with holes in hood edge. Ensure that the hood shield is **BETWEEN** the grill and the hood.' The number '13' is in a box at the bottom left.

Reattach the grill by reinstalling (5) bolts previously removed.

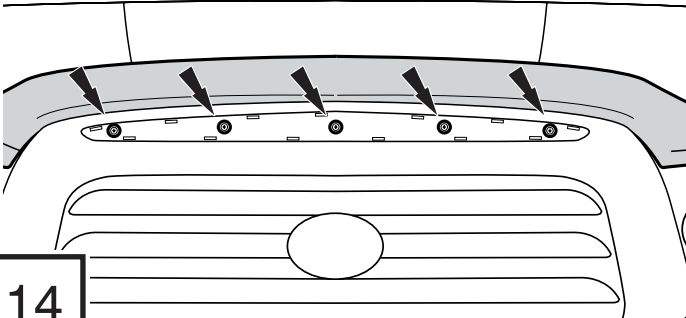

14

This panel shows the grill being reattached to the hood. A top-down view of the hood edge is shown with five bolts being inserted into holes. Arrows point to each bolt. A screwdriver icon is shown in a small inset box. The text above the diagram says 'Reattach the grill by reinstalling (5) bolts previously removed.' The number '14' is in a box at the bottom left.

Carefully raise hood.

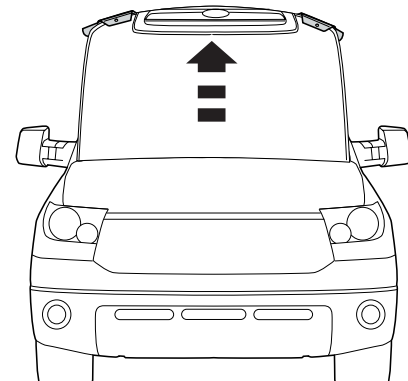

15

This panel shows the hood being raised. A top-down view of the car's front end is shown with a large upward-pointing arrow above the hood, indicating the direction of movement. The number '15' is in a box at the bottom left.

Reach under the hood to the backside of the grill, and reinstall (10) nuts previously removed.

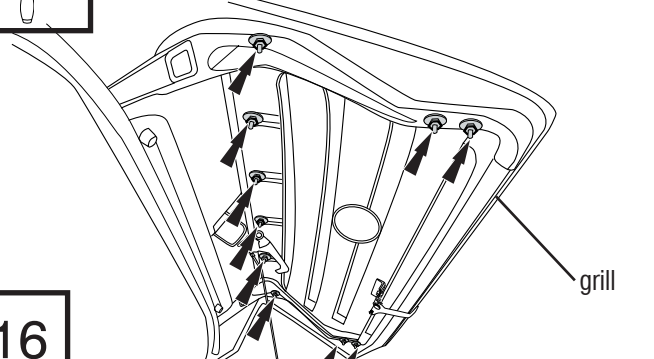

16

This panel shows the nuts being reinstalled on the backside of the grill. A perspective view of the hood and grill is shown. Arrows point to ten nuts being inserted into the back of the grill. A label 'grill' points to the grill assembly. A screwdriver icon is shown in a small inset box. The text above the diagram says 'Reach under the hood to the backside of the grill, and reinstall (10) nuts previously removed.' The number '16' is in a box at the bottom left.

Reach under the hood to the backside of the grill and reattach the hood lock rod to the grill.

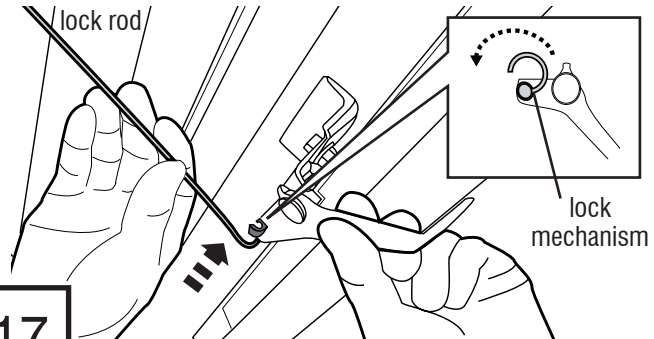

17

This panel shows the hood lock rod being reattached to the grill. A close-up view shows a hand holding the lock rod and another hand holding the lock mechanism. An inset diagram shows the lock mechanism being rotated. A label 'lock rod' points to the rod, and a label 'lock mechanism' points to the mechanism. The text above the diagram says 'Reach under the hood to the backside of the grill and reattach the hood lock rod to the grill.' The number '17' is in a box at the bottom left.

Carefully close hood.

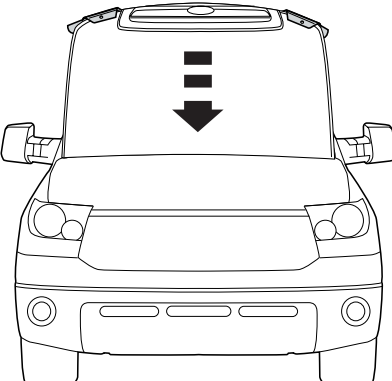

18

This panel shows the hood being closed. A top-down view of the car's front end is shown with a large downward-pointing arrow above the hood, indicating the direction of movement. The number '18' is in a box at the bottom left.

Installation Steps **NOTE:** Actual application may vary slightly from illustrations.

Carefully reinstall the previously removed applique. Slide the top clips in first, then press firmly to snap remaining tabs into place.

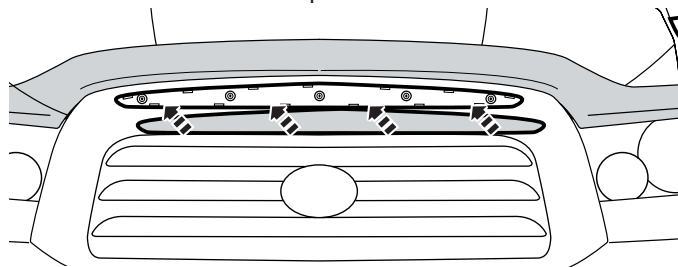

19



Apply (4) Bump ons to hood surface.

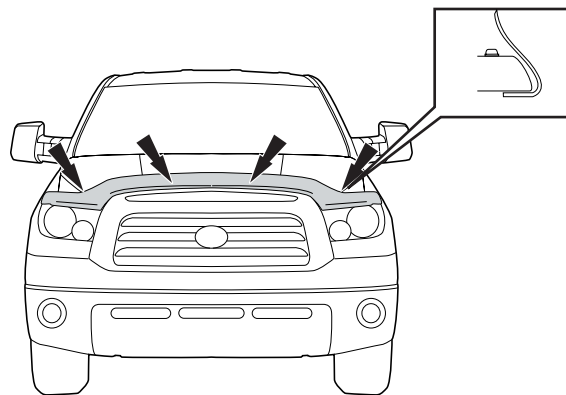

20

Care and Cleaning

- Wash only with mild soap & dry with a clean cloth.

Congratulations!

You have purchased one of the many quality Auto Ventshade™ branded products offered by Lund International, Inc. We take the utmost pride in our products and want you to enjoy years of satisfaction from your investment. We have made every effort to ensure that your product is top quality in terms of fit, durability, finish and ease of installation.



AUTO VENTSHADE™

Lund International, Ventshade Accessories Division

655 Raco Drive, Lawrenceville, GA 30045

800-241-7219 • Fax 770-339-5839 • Visit us at lundinternational.com



© 2006 Lund International, Inc. All rights reserved.
Auto Ventshade™, the Auto Ventshade™ logo and the AVS™ logo are trademarks of Lund International, Inc.





AUTO VENT SHADE™

Bugflector® - Bugflector II® - Carflector™

Pour obtenir une installation correcte et le meilleur ajustement possible, lire toutes les instructions AVANT de commencer.

Pour toute assistance technique ou obtention de pièces manquantes, appeler le service des relations avec la clientèle au 1-800-241-7219.

Informations importantes concernant la sécurité



- ATTENTION – Avant de conduire, s'assurer que le pare-insectes est solidement assujéti sur le véhicule.
- Ne pas utiliser les stations de lavage de voitures à brosses.
- Ne pas utiliser de solvants.
- Vérifier régulièrement le serrage des composants.

Contenu

REMARQUE : Le produit peut être différent de celui représenté sur l'illustration.



Pare-insectes



Attache (2)



Butoirs (4)

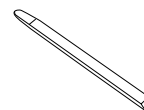

Levier x1

Outils nécessaires



Fournitures pour lavage de voiture

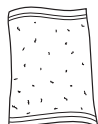

Serviette propre

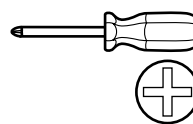

Tournevis cruciforme

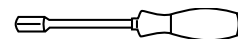

Tournevis à douille de 10 mm

Préparation pour la peinture/l'installation

- Il est recommandé de procéder à un essai pour s'assurer que le positionnement et l'ajustement sont corrects.
- Vérifier l'ajustement des pièces avant peinture, car nous n'acceptons pas le retour de pièces modifiées ou peintes.
- Laver le véhicule pour éliminer toute poussière et tous débris.
- Sécher le capot avec une serviette propre.

Étapes d'installation

REMARQUE : La méthode d'application peut être légèrement différente de celle représentée par les illustrations.

Localiser le recouvrement en plastique sur la calandre.

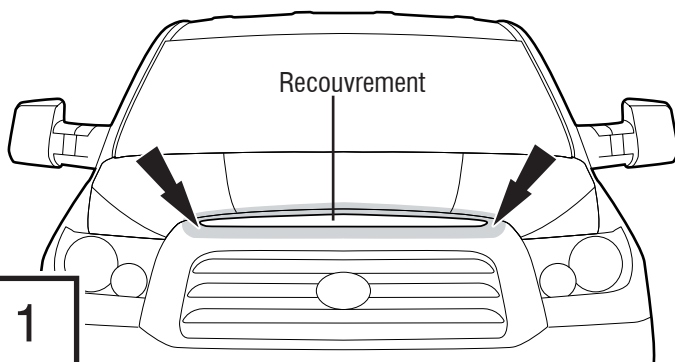

1



À l'aide du levier fourni, soulever avec précaution le recouvrement en plastique pour le détacher de la calandre. Soulever d'abord le coin inférieur du côté conducteur et continuer tout le long du recouvrement jusqu'au coin inférieur du côté passager. Retirer le recouvrement.

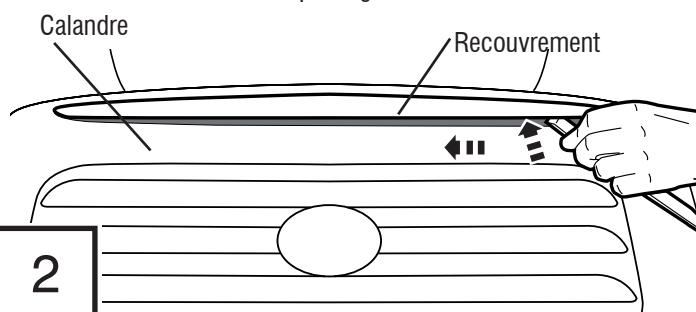

2

Étapes d'installation

REMARQUE : La méthode d'application peut être légèrement différente de celle représentée par les illustrations.



Une fois le recouvrement retiré, se servir d'un tournevis à douille de 10 mm pour retirer les 5 boulons exposés.

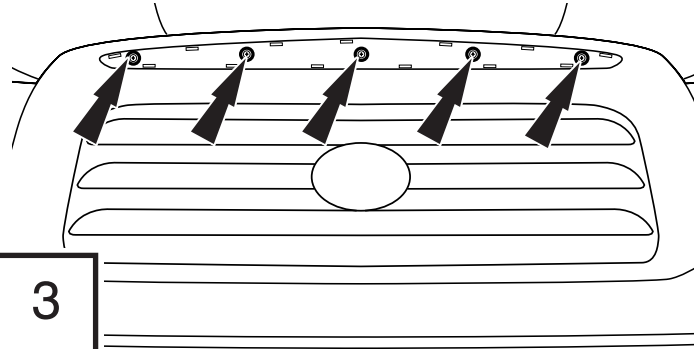

3

Ouvrir le capot avec précaution.

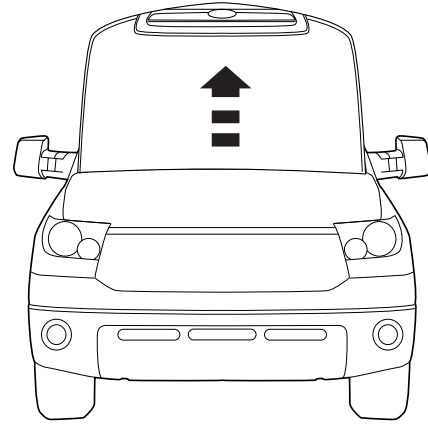

4

Sous le capot à l'arrière de la calandre, déconnecter de la calandre la tige de verrouillage du capot en dégageant le mécanisme de verrouillage et en éloignant avec précaution la tige de la calandre en la soulevant.

Tige de verrouillage

Mécanisme de verrouillage

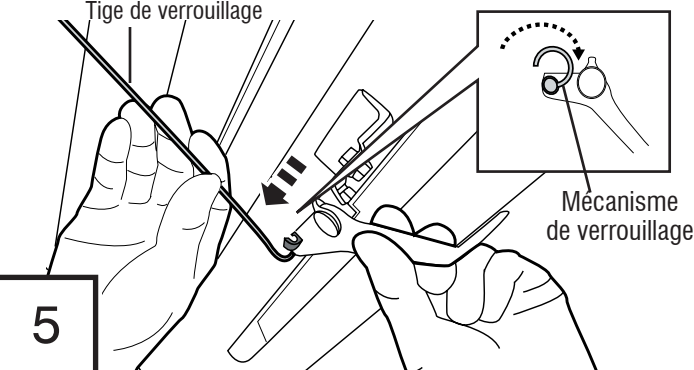

5



Sous le capot à l'arrière de la calandre, retirer 10 écrous à l'aide d'un tournevis à douille.

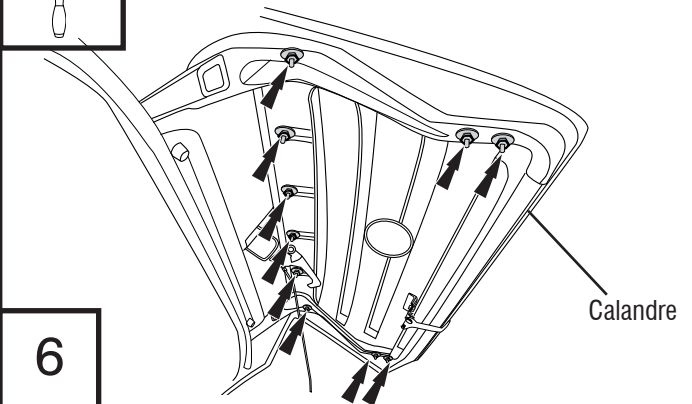

Calandre

6

Fermer le capot avec précaution.

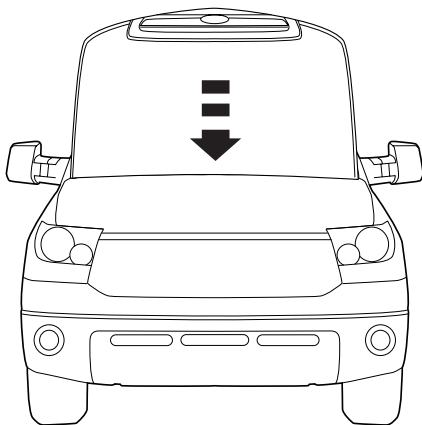

7

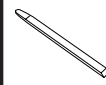

En commençant par le coin supérieur de la calandre du côté conducteur, puis en passant au côté passager, se servir du levier fourni pour soulever avec précaution la calandre et la détacher du capot. Mettre la calandre de côté.

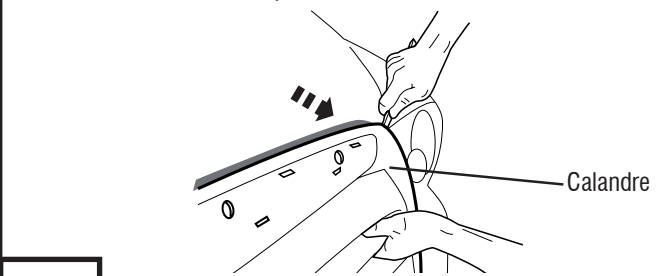

Calandre

8

REMARQUE : La séparation de la calandre du véhicule produit un bruit sec. Ce bruit est normal.



Nettoyer l'avant du rebord du capot, puis soulever avec précaution le capot.

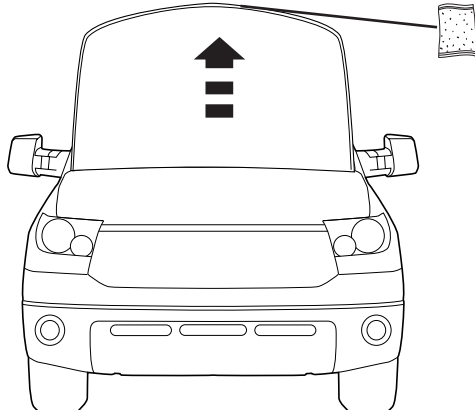

9

Aligner le pare-insectes et le rebord du capot.

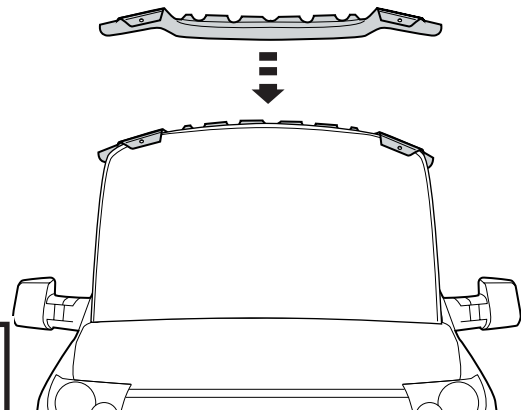

10

Étapes d'installation

REMARQUE : La méthode d'application peut être légèrement différente de celle représentée par les illustrations.

11

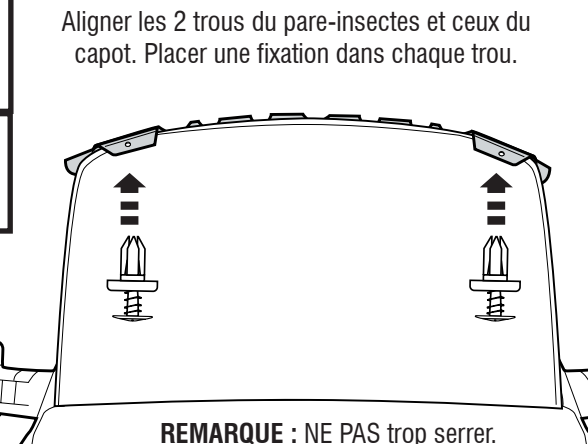

Alligner les 2 trous du pare-insectes et ceux du capot. Placer une fixation dans chaque trou.

REMARQUE : NE PAS trop serrer.

12

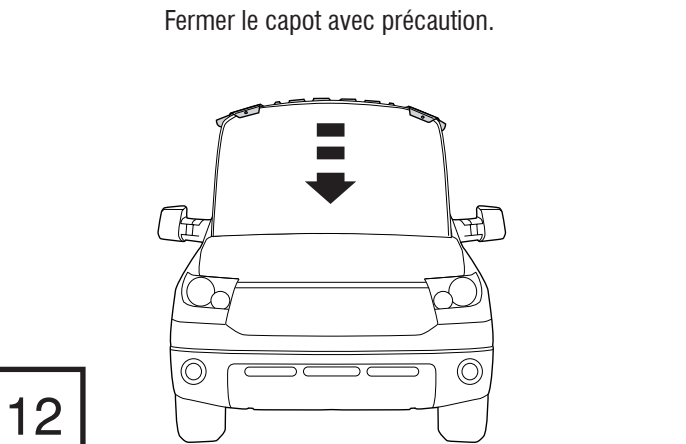

Fermer le capot avec précaution.

13

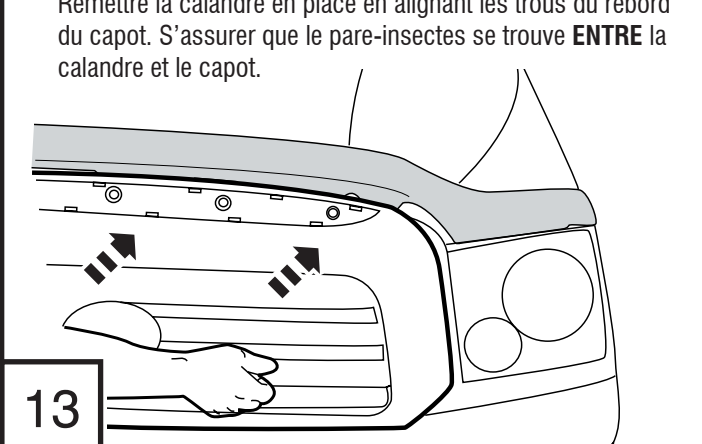

Remettre la calandre en place en alignant les trous du rebord du capot. S'assurer que le pare-insectes se trouve **ENTRE** la calandre et le capot.

14

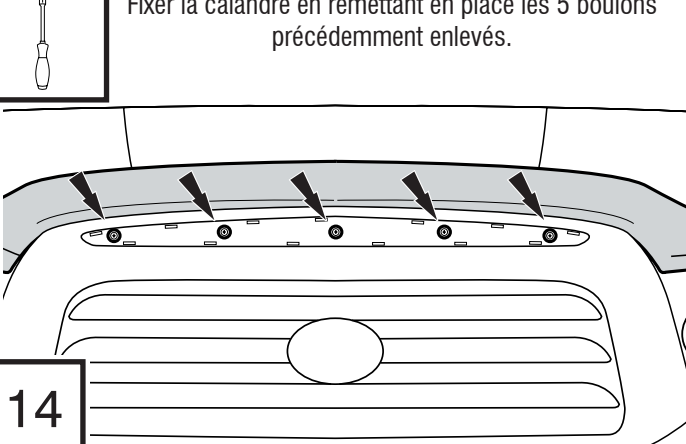

Fixer la calandre en remettant en place les 5 boulons précédemment enlevés.

15

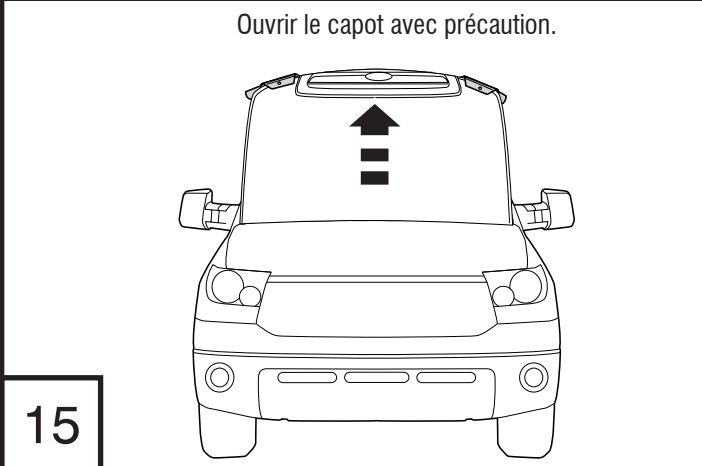

Ouvrir le capot avec précaution.

16

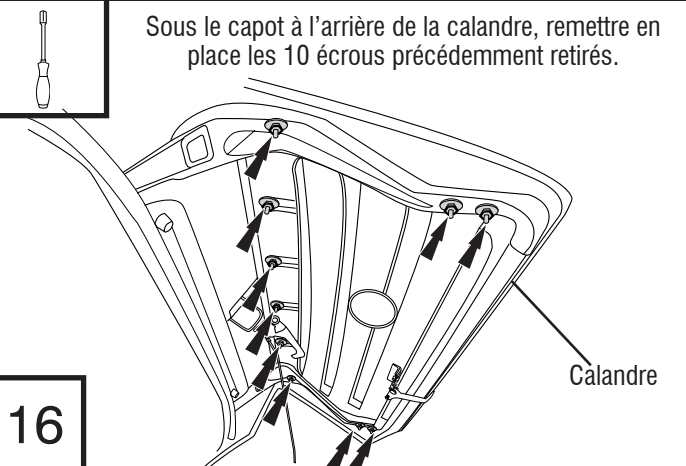

Sous le capot à l'arrière de la calandre, remettre en place les 10 écrous précédemment retirés.

Calandre

17

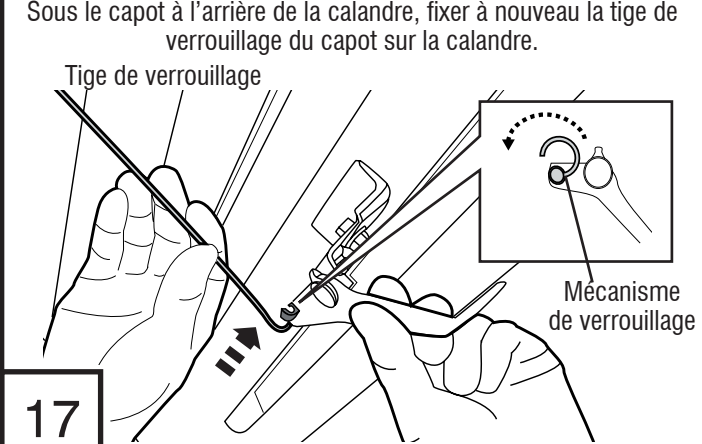

Sous le capot à l'arrière de la calandre, fixer à nouveau la tige de verrouillage du capot sur la calandre.

Tige de verrouillage

Mécanisme de verrouillage

18

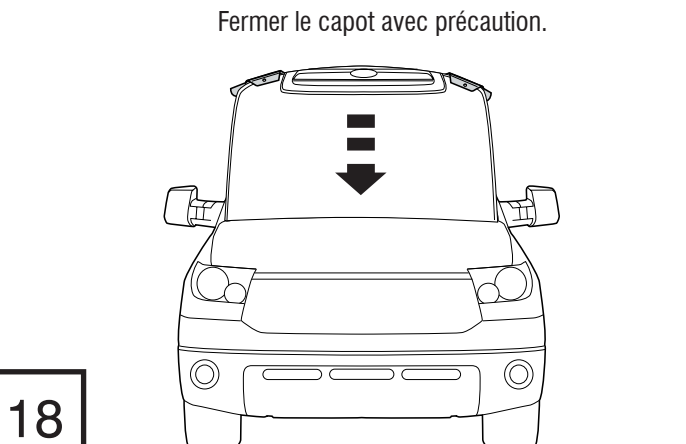

Fermer le capot avec précaution.

Remettre en place avec précaution le recouvrement précédemment retiré. Faire d'abord glisser les clips supérieurs, puis appuyer fermement pour emboîter les languettes restantes en place.

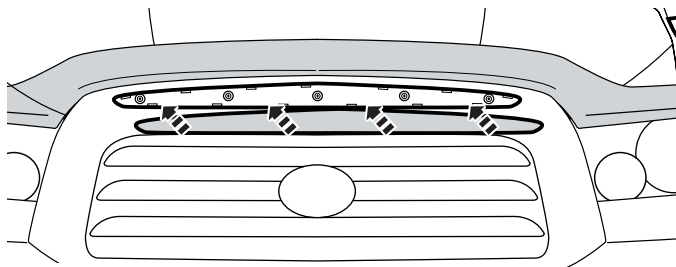

19



Appliquer 4 butoirs sur la surface du capot.

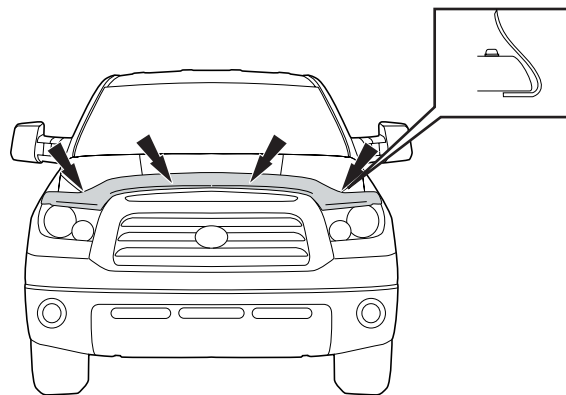

20

Entretien et nettoyage

- Laver exclusivement avec de l'eau savonneuse et sécher avec un chiffon propre.

Félicitations !

Vous avez acheté l'un des nombreux produits de qualité Auto Ventshade™ offerts par Lund International, Inc. Nous sommes extrêmement fiers de nos produits et souhaitons que vous tiriez des années de satisfaction de votre investissement. Nous avons pris toutes les mesures nécessaires pour assurer que ce produit est d'une qualité supérieure en ce qui concerne l'ajustement, la durabilité, la finition et la facilité d'installation.



AUTO VENTSHADE™

Lund International, Ventshade Accessories Division

655 Raco Drive, Lawrenceville, GA 30045, USA

800-241-7219 • Fax 770-339-5839 • Visitez notre site lundinternational.com



™

Auto Ventshade™, le logo Auto Ventshade™ et le logo AVS™ sont des marques déposées de Lund International, Inc.





Bugflector® - Bugflector II® - Carflector™

Para una instalación adecuada y el mejor ajuste posible, lea todas las instrucciones ANTES de comenzar. Si desea recibir asistencia técnica u obtener piezas faltantes, llame al Servicio al cliente al 1-800-241-7219.

Información importante de seguridad



- PRECAUCIÓN - Antes de conducir, asegúrese de que la cubierta para capó esté correctamente anclada al vehículo.
- No utilice servicios automáticos de limpieza de vehículos que utilizan cepillos.
- No utilice limpiadores al solvente de ningún tipo.
- Compruebe periódicamente que todos los componentes estén ajustados.

Contenido AVISO: El producto real puede variar con respecto a las ilustraciones.



Cubierta para capó



Sujetador
x2



Soporte
x 4

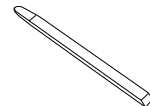

Palanca x1

Herramientas necesarias



Equipo de limpieza de
vehículos

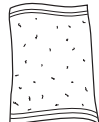

Toalla limpia

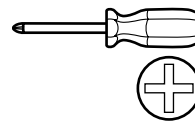

Destornillador de cabeza Phillips

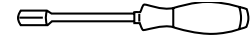

Llave para tuercas de
10 mm

Preparación antes de pintar o instalar

- Se recomienda realizar un ajuste de prueba para asegurar el posicionamiento y ajuste correctos.
- Compruebe que las piezas se ajusten correctamente antes de pintarlas, ya que no aceptaremos la devolución de piezas modificadas o pintadas.
- Lave el capó del vehículo para quitar los desechos y la suciedad.
- Seque el capó con una toalla limpia.

Pasos de instalación AVISO: La colocación real puede variar con respecto a las ilustraciones.

Ubique el aplique plástico de la parrilla.

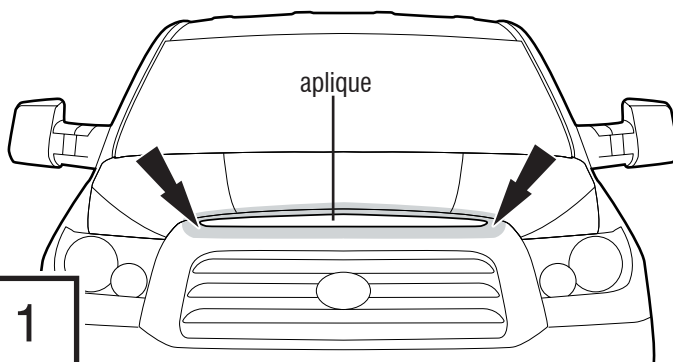

1

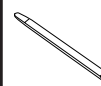

Quite cuidadosamente el aplique plástico de la parrilla utilizando la Palanca provista. Comience por levantar la esquina inferior de lado del conductor y continúe hacia la esquina inferior del lado del acompañante.

Quite el aplique.

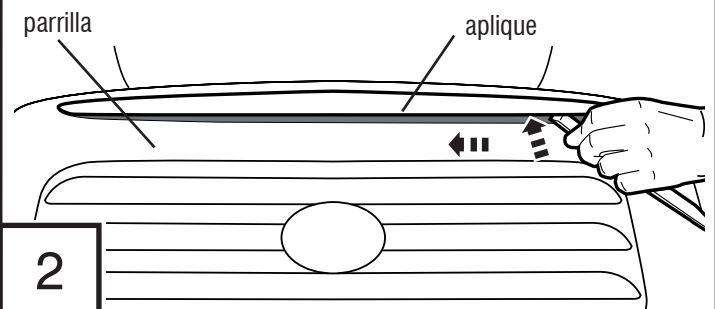

2

Pasos de instalación **AVISO:** La colocación real puede variar con respecto a las ilustraciones.



Una vez retirado el aplique, quite los (5) tornillos visibles con una llave para tuercas de 10 mm.

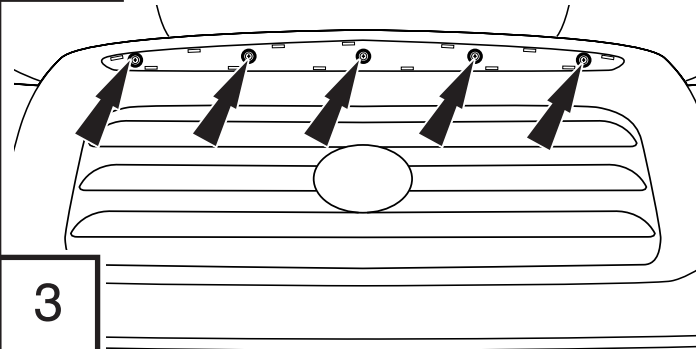

3

Levante cuidadosamente el capó.

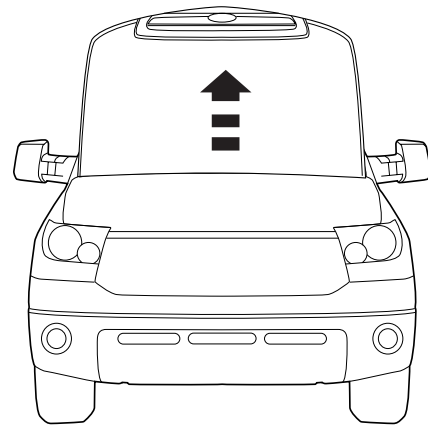

4

Desde abajo del capó y por detrás de la parrilla, desenganche de la parrilla la varilla de soporte del capó. Para esto libere el mecanismo de trabas y separe suavemente la varilla de la parrilla.

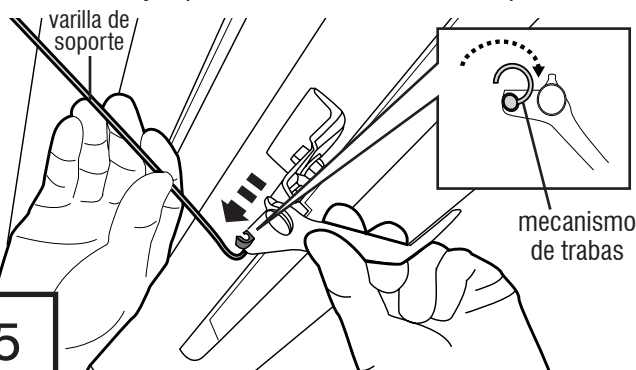

5



Desde abajo del capó y por detrás de la parrilla, quite las (10) tuercas con una llave para tuercas.

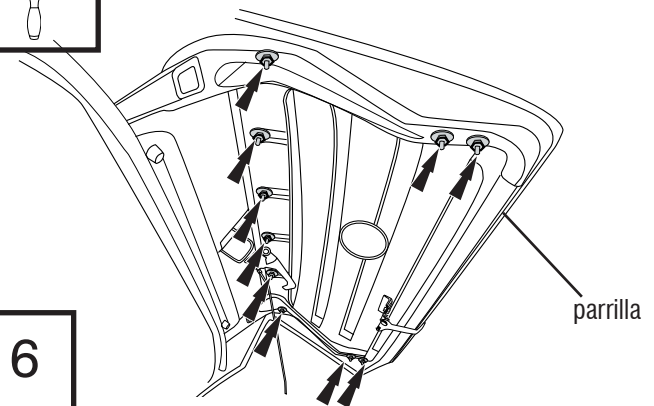

6

Baje cuidadosamente el capó.

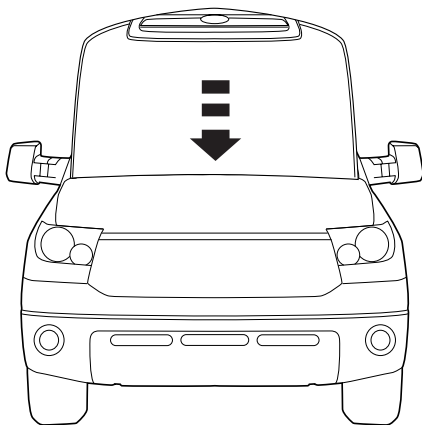

7



Con la Palanca provista, destrabe cuidadosamente la parrilla del capó. Comience por la esquina superior de la parrilla del lado del conductor y, luego, siga por el lado del acompañante. Aparte la parrilla.

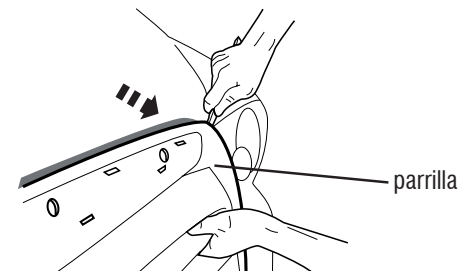

8

AVISO: Cuando separe la parrilla del vehículo oírás un chasquido. Esto es normal.



Limpie el borde delantero del capó y levante el capó cuidadosamente.

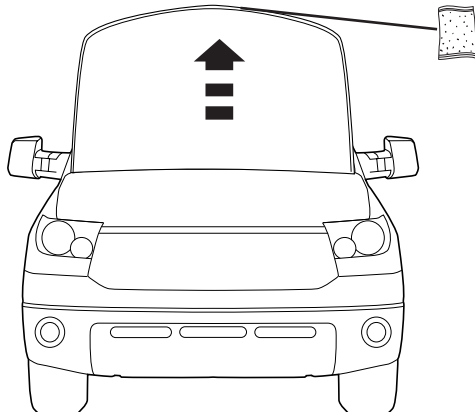

9

Alinee la cubierta para capó con el borde del capó.

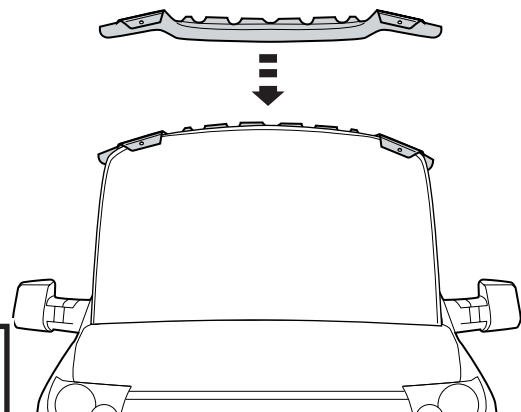

10

Pasos de instalación **AVISO:** La colocación real puede variar con respecto a las ilustraciones.

11

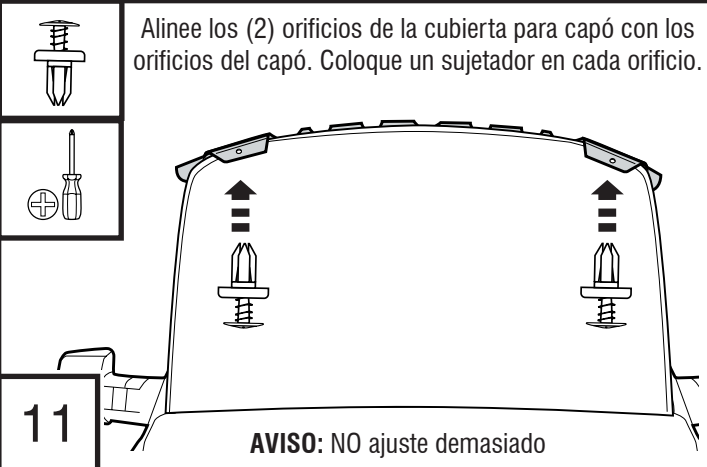

Alinee los (2) orificios de la cubierta para capó con los orificios del capó. Coloque un sujetador en cada orificio.

AVISO: NO ajuste demasiado

12

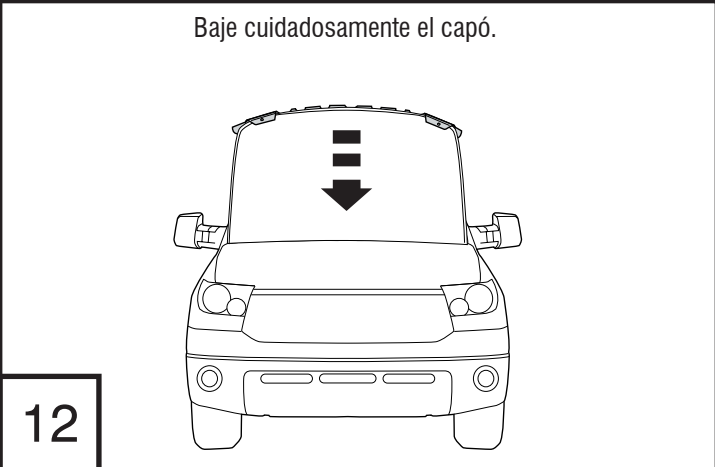

Baje cuidadosamente el capó.

13

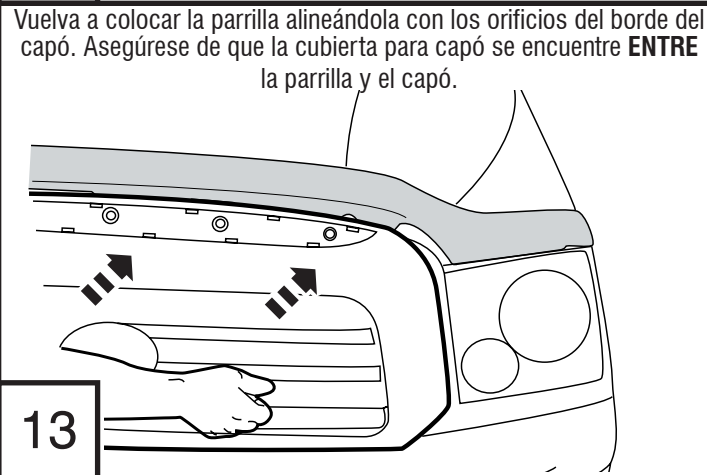

Vuelva a colocar la parrilla alineándola con los orificios del borde del capó. Asegúrese de que la cubierta para capó se encuentre **ENTRE** la parrilla y el capó.

14

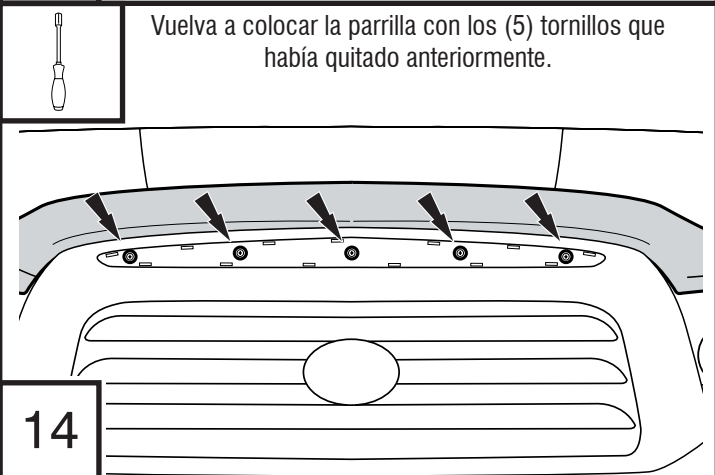

Vuelva a colocar la parrilla con los (5) tornillos que había quitado anteriormente.

15

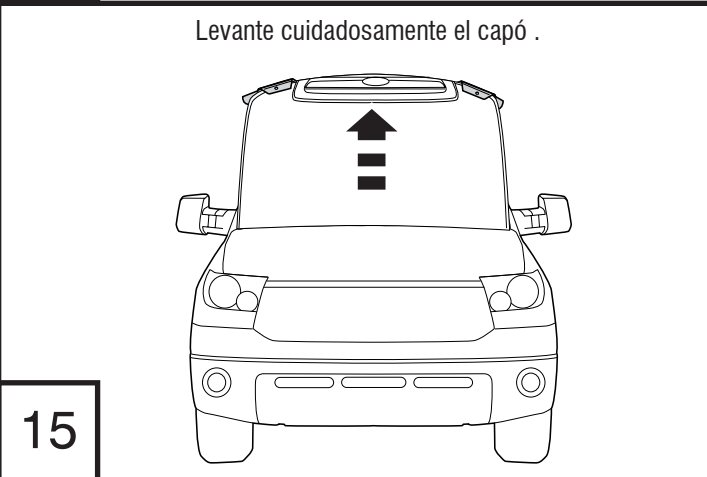

Levante cuidadosamente el capó.

16

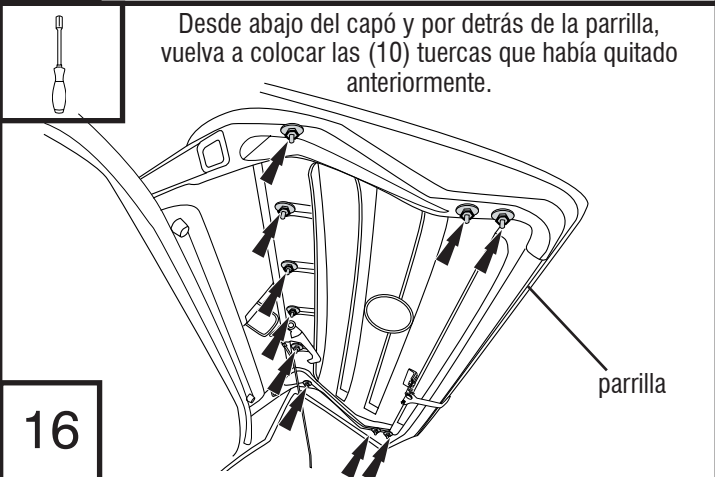

Desde abajo del capó y por detrás de la parrilla, vuelva a colocar las (10) tuercas que había quitado anteriormente.

parrilla

17

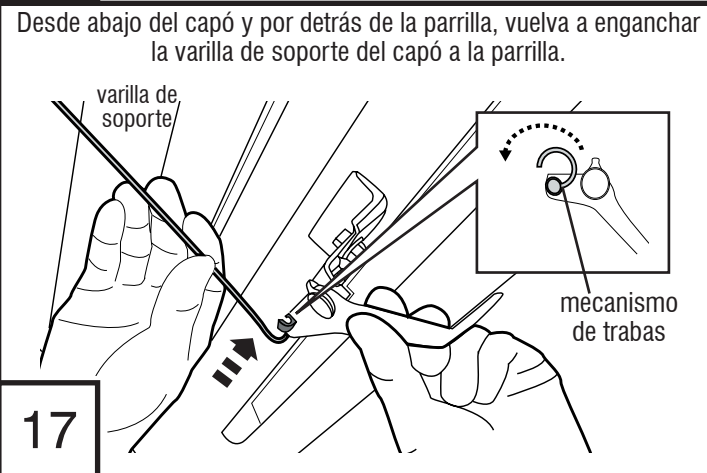

Desde abajo del capó y por detrás de la parrilla, vuelva a enganchar la varilla de soporte del capó a la parrilla.

varilla de soporte

mecanismo de trabas

18



Cierre cuidadosamente el capó.

Cuidadosamente, vuelva a colocar el aplique que había quitado anteriormente. Primero introduzca las presillas superiores y luego presione con fuerza para que todas las lengüetas encajen en su lugar.

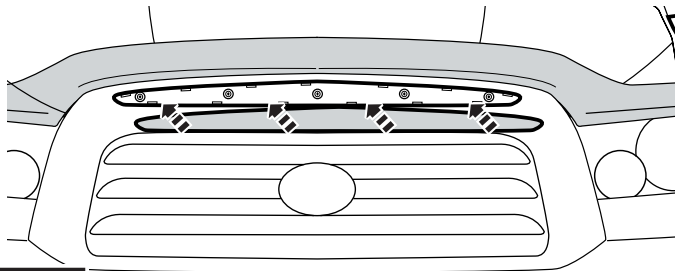

19



Coloque (4) Soportes en la superficie del capó.

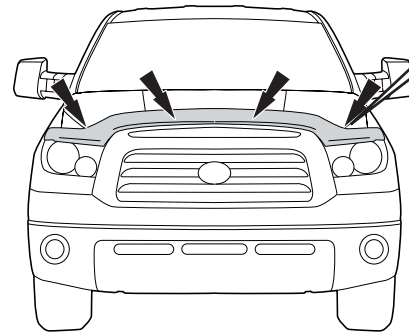

20

Cuidado y limpieza

- Limpie solamente con agua jabonosa tibia y seque con un paño limpio.

Felicidades

Usted ha comprado uno de los tantos artículos de calidad de Auto Ventshade™ ofrecidos por Lund International, Inc. Nuestros productos son nuestro mayor orgullo. Deseamos que disfrute de años de satisfacción con su inversión. Hemos realizado todos los esfuerzos para asegurarnos de que su producto sea de la mejor calidad en cuanto a ajuste, durabilidad, acabado y facilidad de instalación.



AUTO VENTSHADE™

Lund International, Ventshade Accessories Division

655 Raco Drive, Lawrenceville, GA 30045

800-241-7219 • Fax 770-339-5839 • Visite nuestro sitio Web: lundinternational.com



© 2007 Lund International, Inc. Todos los derechos reservados.
™ Auto Ventshade™, el logo de Auto Ventshade™ y el logo de AVS™ son marcas comerciales de Lund International, Inc.

