

Installation Instructions

I - Sheet Number BF54 Rev.A



Bugflector® - Bugflector II® - Carflector®

For proper installation and best possible fit, please read all instructions **BEFORE** you begin.
For technical assistance or to obtain missing parts, please call Customer Relations at 1-800-241-7219.

Important Safety Information



- CAUTION - Before driving, ensure that the hood shield is properly secured to vehicle.
- Do not use automatic "brush-style" car washes.
- Do not use cleaning solvents of any kind.
- Periodically check all components for tightness.

Contents

NOTE: Actual product may vary from illustration.

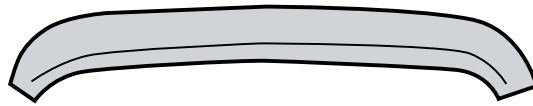

Hood shield



Bump Ons x4

Tools Required



Car Wash Supplies

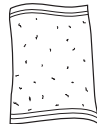

Clean Towel



Nut driver

Preparation Before Painting / Installation

- A trial fit is recommended to ensure proper positioning and fit.
- Check fit of parts before painting as we will not accept the return of modified or painted parts.
- Wash and dry your vehicle to remove any debris and/or dirt from the installation area.

Installation Steps

NOTE: Actual application may vary slightly from illustrations.

Open hood.

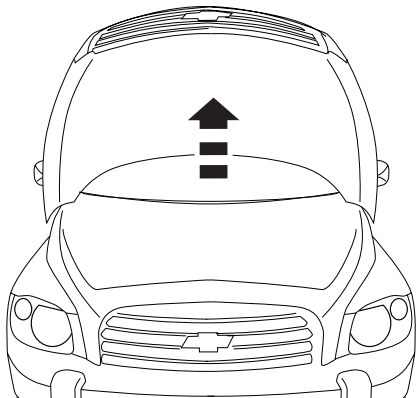

1

Locate and remove (2) rubber caps covering out-board grill mounting screws.

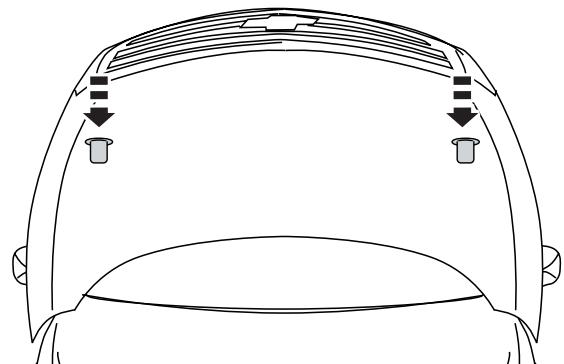

2

Installation Steps

NOTE: Actual application may vary slightly from illustrations.



Remove (5) nuts from the backside of the grill that secure it to the hood. Carefully set grill aside.

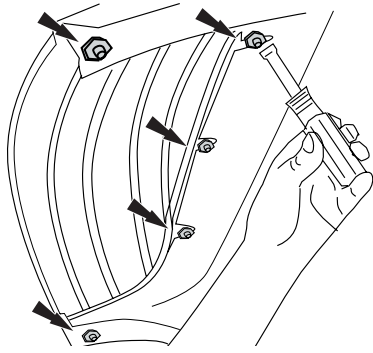

3

Align hood shield in place along the center of the hood edge.

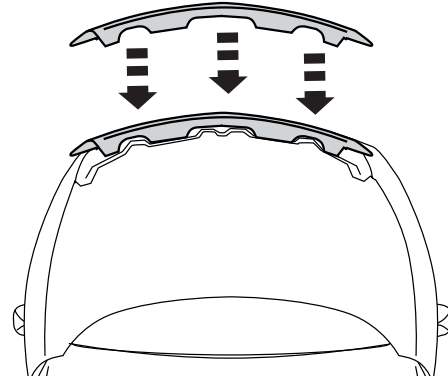

4

Replace grill assembly. The hood shield should be positioned **between** the hood and the grill.

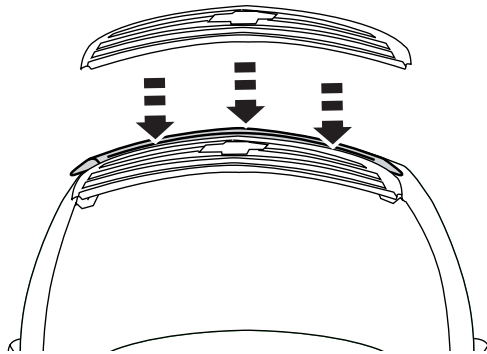

5



Reinstall (5) previously removed nuts on the backside of grill.

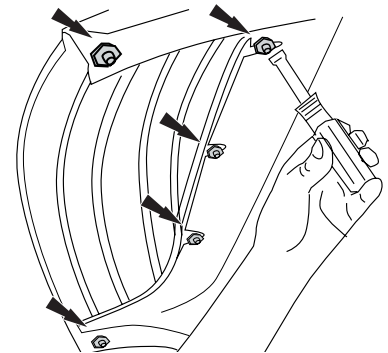

6

Replace (2) previously removed rubber caps on end nuts.

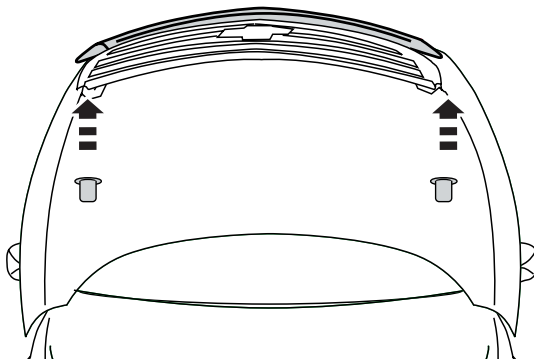

7



Close hood and install bump ons.

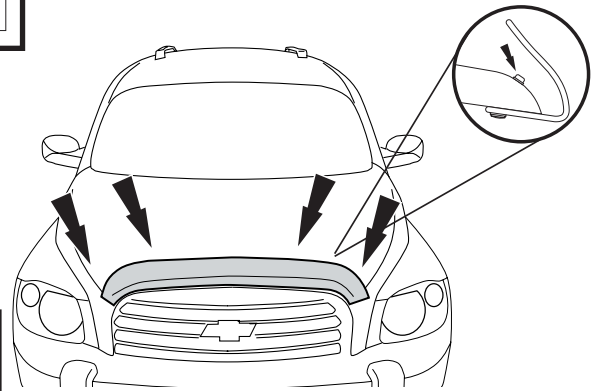

8

Care and Cleaning

- Wash only with mild soap & dry with a clean cloth.

Congratulations!

You have purchased one of the many quality Auto Ventshade™ branded products offered by Lund International, Inc. We take the utmost pride in our products and want you to enjoy years of satisfaction from your investment. We have made every effort to ensure that your product is top quality in terms of fit, durability, finish and ease of installation.



AUTO VENTSHADE™

Lund International, Ventshade Accessories Division

655 Raco Drive, Lawrenceville, GA 30045

800-241-7219 • Fax 770-339-5839 • Visit us at lundinternational.com

© 2005 Lund International, Inc. All rights reserved.

Auto Ventshade™, the Auto Ventshade™ logo and the AVS™ logo are trademarks of Lund International, Inc.





Bugflector® - Bugflector II® - Carflector®

Pour obtenir une installation correcte et le meilleur ajustement possible, lire toutes les instructions AVANT de commencer. Pour toute assistance technique ou obtention de pièces manquantes, appeler le service des relations avec la clientèle au 1-800-241-7219.

Informations importantes concernant la sécurité



- ATTENTION – Avant de conduire, s'assurer que le pare-insectes est solidement assujettie sur le véhicule.
- Ne pas utiliser les stations de lavage de voitures à brosse.
- Ne pas utiliser de solvants.
- Vérifier régulièrement le serrage des composants.

Contenu

NOTE: Le produit réel peut changer de l'illustration.

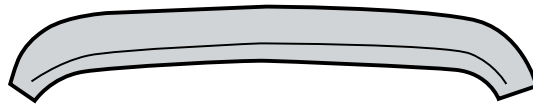

Pare-insectes



Butoirs (4)

Outils nécessaires



Fournitures pour lavage de voiture



Serviette propre



clé à douille

Préparation pour la peinture/l'installation

- Il est recommandé de procéder à un essai pour s'assurer que le positionnement et l'ajustement sont corrects.
- Vérifier l'ajustement des pièces avant peinture, car nous n'acceptons pas le retour de pièces modifiées ou peintes.
- Laver les glissières de glaces de la portière du véhicule pour éliminer toute poussière et tous débris.
- Sécher les glissières avec une serviette propre.

Étapes d'installation

REMARQUE : La méthode d'application peut être légèrement différente de celle représentée par les illustrations.

Ouvrir le capot.

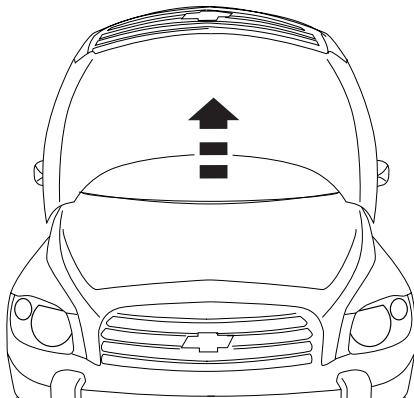

1

Localiser et retirer les (2) capuchons en caoutchouc qui couvrent les vis de montage extérieures de la calandre.

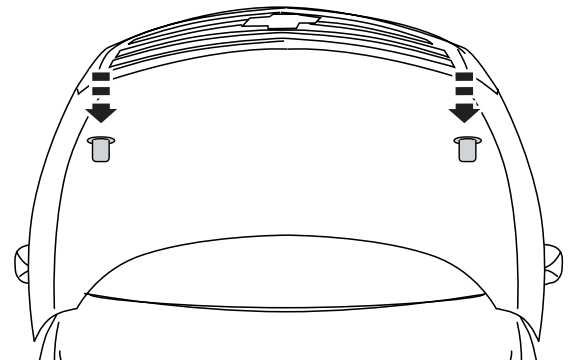

2

Étapes d'installation

REMARQUE : La méthode d'application peut être légèrement différente de celle représentée par les illustrations.



Retirer de l'arrière de la calandre les (5) écrous qui la fixent au capot. Mettre la calandre de côté avec précaution.

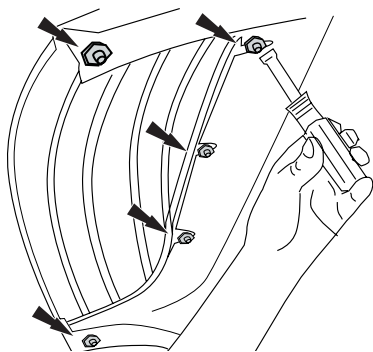

3

Mettre le pare-insectes en place en l'alignant le long du centre du rebord du capot.

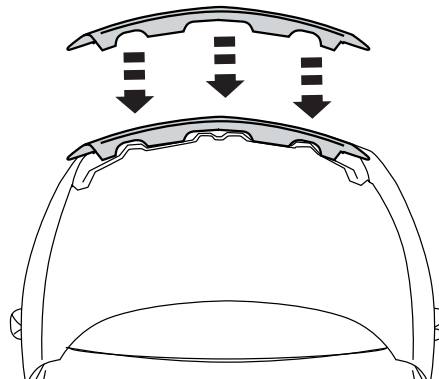

4

Remettre la calandre en place. Le pare-insectes doit être placé **entre** le capot et la calandre.

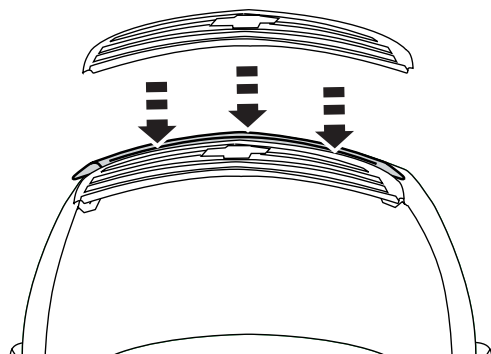

5



Remettre en place les (5) écrous précédemment retirés de l'arrière de la calandre.

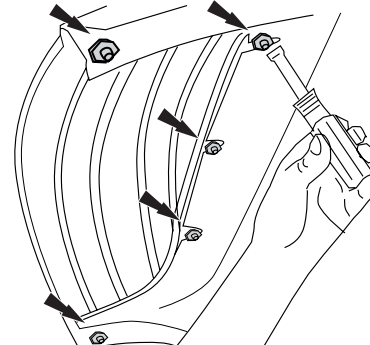

6

Remettre en place sur les écrous d'extrémité les (2) capuchons en caoutchouc précédemment retirés.

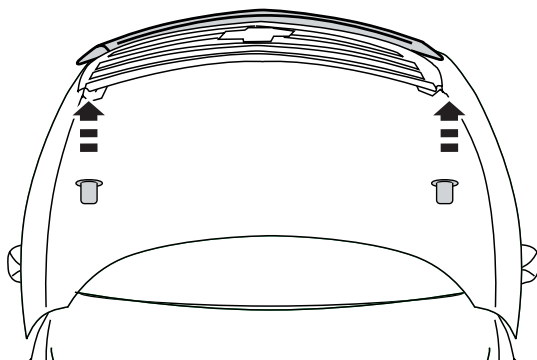

7



Fermer le capot et mettre les butoirs en place.

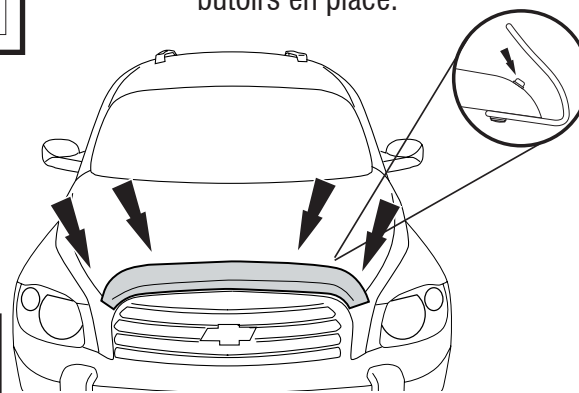

8

Entretien et nettoyage

- Laver exclusivement avec de l'eau savonneuse et sécher avec un chiffon propre.

Félicitations !

Vous avez acheté l'un des nombreux produits de qualité Auto Ventshade™ fabriqués par Lund International, Inc. Nous sommes extrêmement fiers de nos produits et souhaitons que vous tiriez des années de satisfaction de votre investissement. Nous avons pris toutes les mesures nécessaires pour assurer que ce produit est d'une qualité supérieure en ce qui concerne l'ajustement, la durabilité, la finition et la facilité d'installation.



AUTO VENTSHADE™
Lund International, Ventshade Accessories Division
655 Raco Drive, Lawrenceville, GA 30045, USA
800-241-7219 • Fax 770-339-5839 • Visitez notre site lundinternational.com

© 2005 Lund International, Inc. Tous droits réservés.

Auto Ventshade™, le logo Auto Ventshade™ et le logo AVS™ sont des marques déposées de Lund International, Inc.





Bugflector® - Bugflector II® - Carflector®

Para una instalación adecuada y el mejor ajuste posible, lea todas las instrucciones ANTES de comenzar. Si desea recibir asistencia técnica u obtener piezas faltantes, llame al Servicio al cliente al 1-800-241-7219.

Información importante de seguridad



- PRECAUCIÓN - Antes de conducir, asegúrese de que la visera deflectora esté correctamente anclada al vehículo.
- No utilice servicios automáticos de limpieza de vehículos que utilizan cepillos.
- No utilice limpiadores al solvente de ningún tipo.
- Compruebe periódicamente que todos los componentes estén ajustados.

Contenido

NOTA: El producto real puede variar de la ilustración.

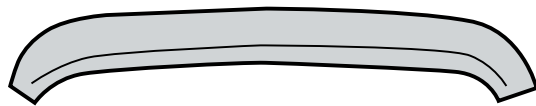

Cubierta para capó



Soporte x 4

Herramientas necesarias



Equipo de limpieza de vehículos

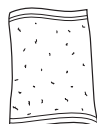

Toalla limpia

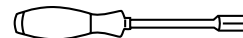

herramienta del zócalo

Preparación antes de pintar o instalar

- Se recomienda realizar un ajuste de prueba para asegurar el posicionamiento y ajuste correctos.
- Compruebe que las piezas se ajusten correctamente antes de pintarlas, ya que no aceptaremos la devolución de piezas modificadas o pintadas.
- Lave los canales de la ventanilla del vehículo para quitar los desechos y la suciedad.
- Seque los canales de la ventanilla con una toalla limpia.

Pasos de instalación

NOTA: El uso real puede variar levemente de ilustraciones.

Abra el capó.

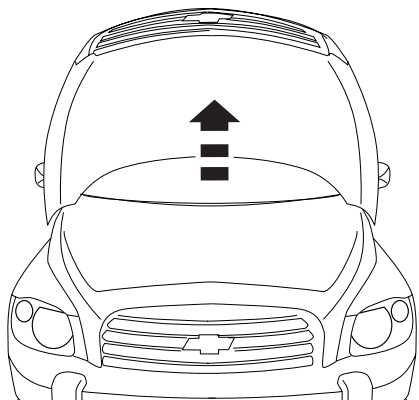

1

Ubique y quite las (2) cubiertas de goma que cubren los tornillos de montaje de la parrilla exterior.

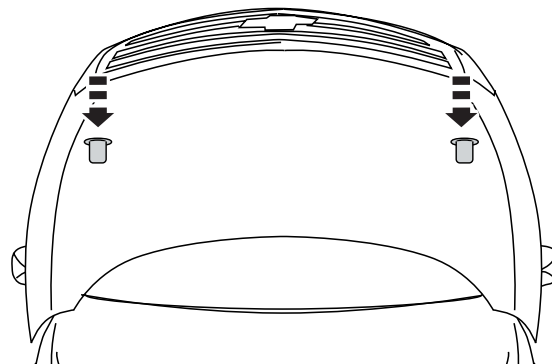

2

Pasos de instalación

NOTA: El uso real puede variar levemente de ilustraciones.



Quite las (5) tuercas de la parte trasera de la parrilla que asegura el capó. Aparte la parrilla con cuidado.

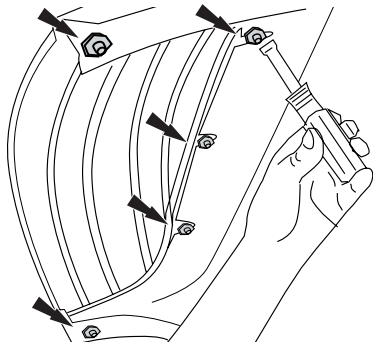

3

Alinee la cubierta para capó en su lugar centrándola en el borde del capó.

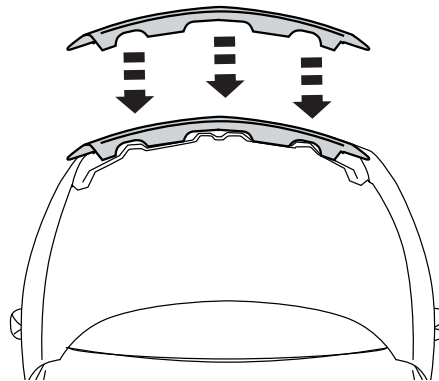

4

Reemplace el conjunto de la parrilla. La cubierta para capó debe ubicarse **entre** el capó y la parrilla.

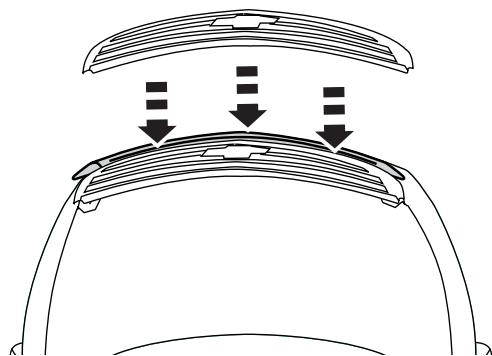

5



Vuelva a instalar las (5) tuercas que había quitado previamente en la parte trasera de la parrilla.

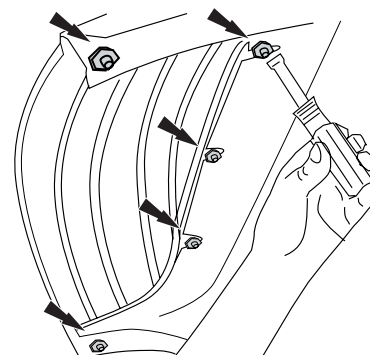

6

Reemplace las (2) cubiertas de goma que retiró anteriormente en el extremo de las tuercas.

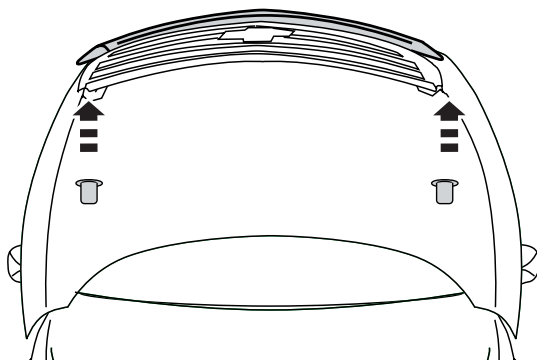

7



Cierre la parrilla e instale los soportes.

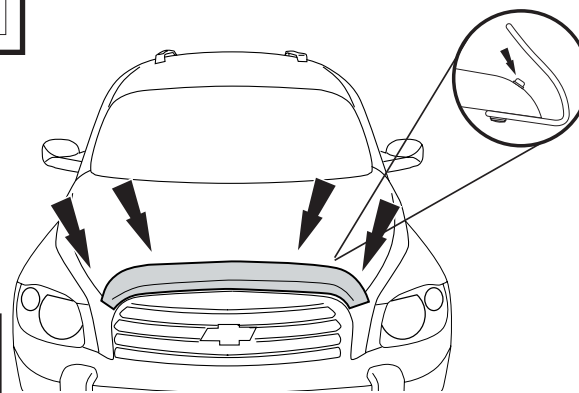

8

Cuidado y limpieza

- Limpie solamente con agua jabonosa tibia y seque con un paño limpio.

Felicidades

Usted ha comprado uno de los tantos artículos de calidad de Auto Ventshade™ ofrecidos por Lund International, Inc. Nuestros productos son nuestro mayor orgullo. Deseamos que disfrute de años de satisfacción con su inversión. Hemos realizado todos los esfuerzos para asegurarnos de que su producto sea de la mejor calidad en cuanto a ajuste, durabilidad, acabado y facilidad de instalación.



AUTO VENTSHADE™

Lund International, Ventshade Accessories Division

655 Raco Drive, Lawrenceville, GA 30045

800-241-7219 • Fax 770-339-5839 • Visite nuestro sitio Web: lundinternational.com

© 2005 Lund International, Inc. Todos los derechos reservados.



Auto Ventshade™, el logo de Auto Ventshade™ y el logo de AVS™ son marcas comerciales de Lund International, Inc.

