



8759 Lion Street
 Rancho Cucamonga, CA 91730
 (909) 476-7225 TECH SUPPORT
 (909) 476-1491 FAX
 www.volantperformance.com

INSTALLATION INSTRUCTIONS PART NO. 16959

READ INSTRUCTIONS THOROUGHLY BEFORE DISASSEMBLING. DO NOT SKIP ANY STEPS. ANY QUESTIONS ON A VOLANT KIT MAY BE REFERRED TO OUR TECH SUPPORT LINE AT (909) 476-7225 OR VISIT OUR WEBSITE AT WWW.VOLANTPERFORMANCE.COM

TOOLS NEEDED FOR INSTALL:

1. 5/16 NUT DRIVER OR FLAT HEAD SCREWDRIVER
2. PHILLIPS SCREWDRIVER

INSTALLATION:

1. Switch the vehicle to the off position and disconnect negative battery cable.
2. Pull the long stock square air duct hose that pulls the air into your throttle body away from the fender well. Then pull it off the stock filter box and away from your engine compartment.
3. Disconnect valve cover breather hose from stock filter box assembly located on top of your throttle body. Then unscrew the large clamp with your screwdriver that holds your stock filter box down to the throttle body. Then remove entire stock filter box assembly off and away from your engine compartment.
4. Install the Volant filter box without the lid and filter to the existing opening where the stock air duct pulls its air. Fasten the Volant filter box to the trucks fender well by using the black tree rivet provided by Volant. Install high performance filter to the Volant filter box lid, use the oval end. Screw lid to the Volant filter box with the 4 screws provided.
5. Hand screw Volant throttle body stud to the middle of the throttle body. Place the 5" gasket on the throttle body. Install the Volant bonnet by inserting the throttle body stud through the Volant bonnet. Then slip rubber washer and fender washer over the stud before screwing on knurled nut

provided by Volant. Do not completely tighten.

6. Connect the 3/2" hump hose to the Volant air duct and Volant filter box. Open hose clamps completely to wrap around hump hose. Close and tighten.
7. Connect the stock valve breather hose to the fitting on the Volant air duct. Completely tighten knurled nut to seal onto the throttle body.
8. Make sure everything is tightened and properly connected.

WARNING: OVER TIGHTENING HARDWARE MAY ALTAR THE INTEGRITY OF THE VOLANT AIR INTAKE SYSTEM.

BEFORE ROAD TESTING

1. Start engine, leaving the transmission in park and securing the parking brake.
2. Make sure to look and listen for any unusual noises or air leaks. Repair problems if needed.
3. Once completed it will be necessary to check periodically for realignment and tightening of all connections.
4. Once all tests are completed, enjoy the performance of your new Volant Air Intake System.

CARE AND CLEANING

Check the cotton reusable filter periodically and remove any excessive dirt build-up by tapping the filter on the ground and brushing off the loosened dirt. Clean the filter by using Volant's Filter Recharger Kit. Volant's Filter Recharger Kit is designed to restore original air flow. Re-oil every 10,000 miles without cleaning to improve filtering in sand and dirt. Clean only when dirt is very excessive or 50,000 miles.

APPLICATION GUIDE

PART NO. 16959

MY	MAKE	MODEL	ENG
2001-2002	DODGE	RAM 1500/2500/3500	3.9L
2001-2002	DODGE	RAM 1500/2500/3500	5.2L
2001-2002	DODGE	RAM 1500/2500/3500	5.9L

RECOMMENDED SERVICE PARTS	PART NO.
VOLANT REPLACEMENT FILTER	5117
AIR FILTER CLEANER KIT	5100
VOLANT PREFILTER	51902

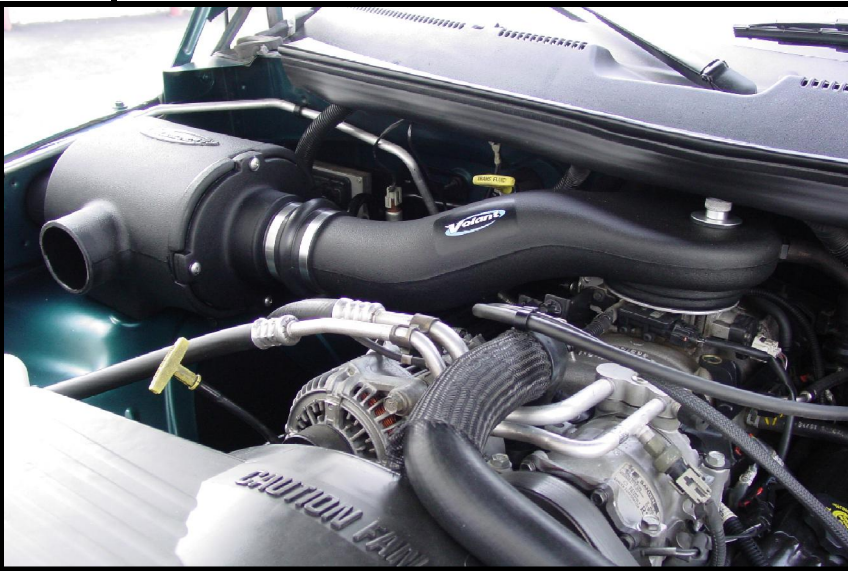

VOLANT AIR INTAKE SYSTEMS
 PART NO.: 16959
 INSTALLATION INSTRUCTIONS
 WWW.VOLANTPERFORMANCE.COM
 TECH SUPPORT: (909) 476-7225

16959 PARTS LIST					
1	FILTER BOX	1	1/4" NUT	1	1/4" KNURLED NUT
1	FILTER BOX LID	1	1/4" LOCK WASHER	1	THRITTLE BODY STUD
1	VOLANT DUCT/BONNET	1	1/4" FENDER WASHER	1	1 1/2" RUBBER BUMPER
1	RAM FILTER W/CLAMP	1	1/4" RUBBER FENDER WASHER	1	5" THRITTLE BODY GASKET
2	#056 CLAMPS	4	1/4"-20 TRUSS HEAD SCREWS		
1	3 1/2" HUMP HOSE	4	1/4" RUBBER WASHERS		
1	1/4"-20 BOLT	1	BLACK TREE RIVOT		

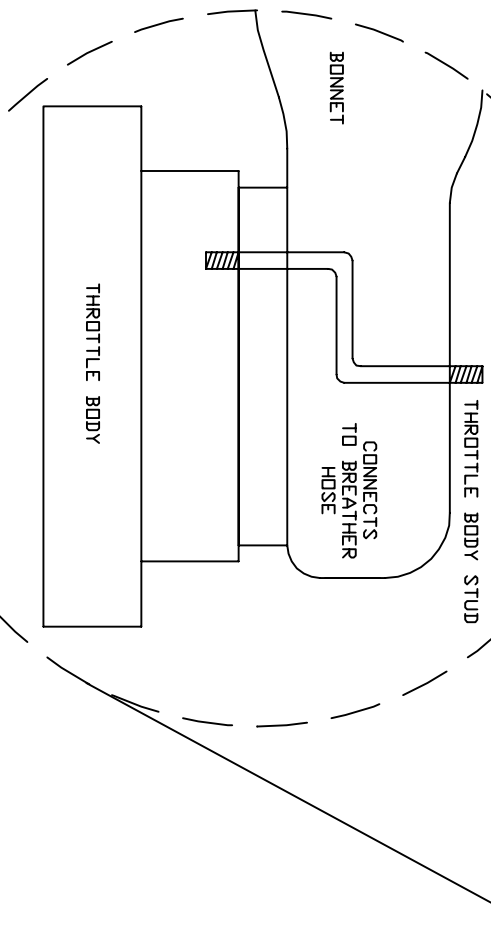
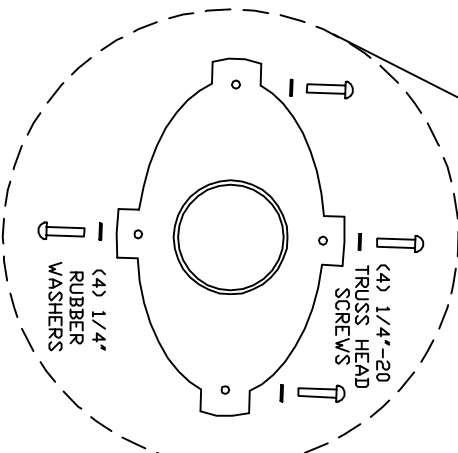
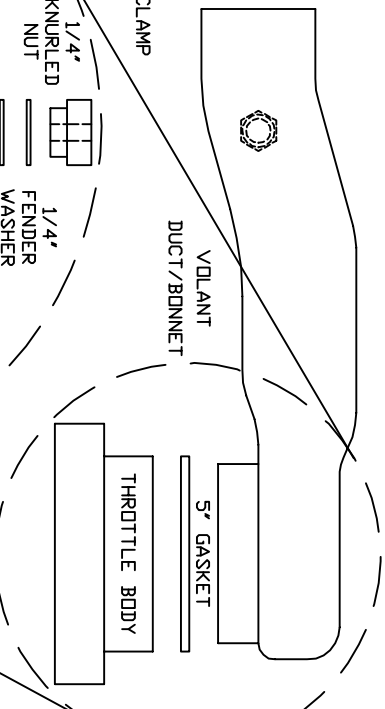
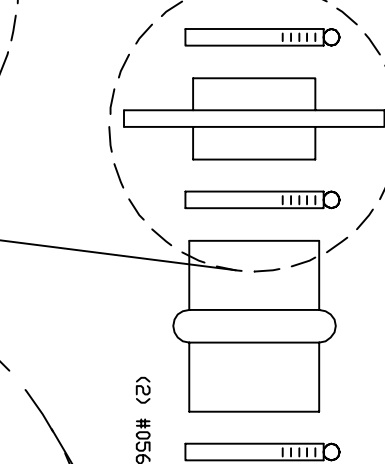
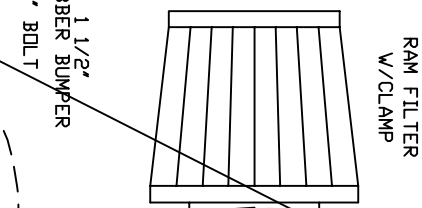
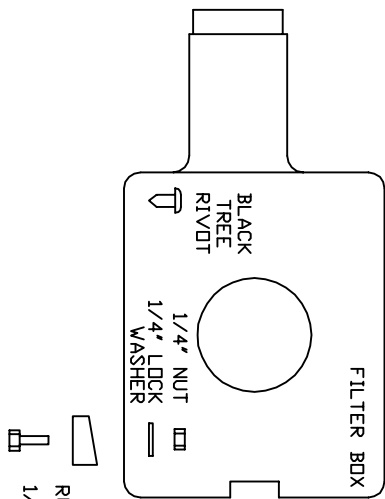

FRONTAL VIEW OF
 FILTER BOX COVER

FIG. A