



# 1964 1/2-66 Ford Mustang

Gen 5 Evaporator Kit

(551964)

(551965)



18865 Goll St. San Antonio, TX 78266

Phone: 800-862-6658

Sales: [sales@vintageair.com](mailto:sales@vintageair.com)

Tech Support: [tech@vintageair.com](mailto:tech@vintageair.com)

[www.vintageair.com](http://www.vintageair.com)



www.vintageair.com

# Table of Contents

Cover.....	1
Table of Contents.....	2
Packing List (551964)/Parts Disclaimer, Packing List (551965)/Parts Disclaimer.....	3
Information Page.....	4
Wiring Notice.....	5
Under Dash Louver Information.....	6
Engine Compartment Disassembly, Condenser Assembly and Installation, Compressor and Brackets.....	7
Passenger Compartment Disassembly.....	8
Firewall Modification and Insulation.....	9
Defrost Duct and Fresh Air Cap Installation, Lubricating O-rings.....	10
Evaporator Preparation, Evaporator Installation (Passenger Compartment).....	11-14
Evaporator Installation (Passenger Compartment) (Cont.), Evaporator Installation (Engine Compartment).....	15
Evaporator Installation (Engine Compartment) (Cont.), Drain Hose Installation.....	16
A/C Hose Installation.....	17
Heater Hose & Heater Control Valve Installation.....	18
Driver Side A/C and Heater Hose Routing.....	19
Passenger Side A/C and Heater Hose Routing.....	20
Passenger Compartment Wiring.....	21
Engine Compartment Wiring.....	22
Center Louver Installation (without Center Console), Center Louver Installation (with Center Console).....	23
Driver- & Passenger-Side Under Dash Louver Installation.....	24
Control Panel & Duct Hose Routing.....	25
Final Steps: Installation Check.....	26
Final Steps: Completing the Install.....	27
Quality Crimp Guideline.....	28
Gen 5 Wiring Diagram.....	29
Gen 5 Wiring Instructions.....	30
Operation of Controls.....	31
Troubleshooting Guide.....	32
Troubleshooting Guide (Cont.), Advanced Diagnostics and Troubleshooting Guide.....	33
Center Console Modification Template.....	34
Packing List (551964), Packing List (551965).....	35



www.vintageair.com

## Packing List: Evaporator Kit (551964)

No.	Qty.	Part No.	Description
1.	1	765200	Gen 5 Super Magnum Evaporator Module
2.	1	781964	Accessory Kit with Conversion Control

**\*\* Before beginning installation, open all packages and check contents of shipment. Please report any shortages directly to Vintage Air within 15 days. After 15 days, Vintage Air will not be responsible for missing or damaged items.**

1

Gen 5 Super Magnum  
Evaporator Module  
765200



2



Accessory Kit  
781964

**NOTE: Images may not depict actual parts and quantities. Refer to packing list for actual parts and quantities.**

## Packing List: Evaporator Kit (551965)

No.	Qty.	Part No.	Description
1.	1	765200	Gen 5 Super Magnum Evaporator Module
2.	1	781965	Accessory Kit with Deluxe Control

**\*\* Before beginning installation, open all packages and check contents of shipment. Please report any shortages directly to Vintage Air within 15 days. After 15 days, Vintage Air will not be responsible for missing or damaged items.**

1

Gen 5 Super Magnum  
Evaporator Module  
765200



2

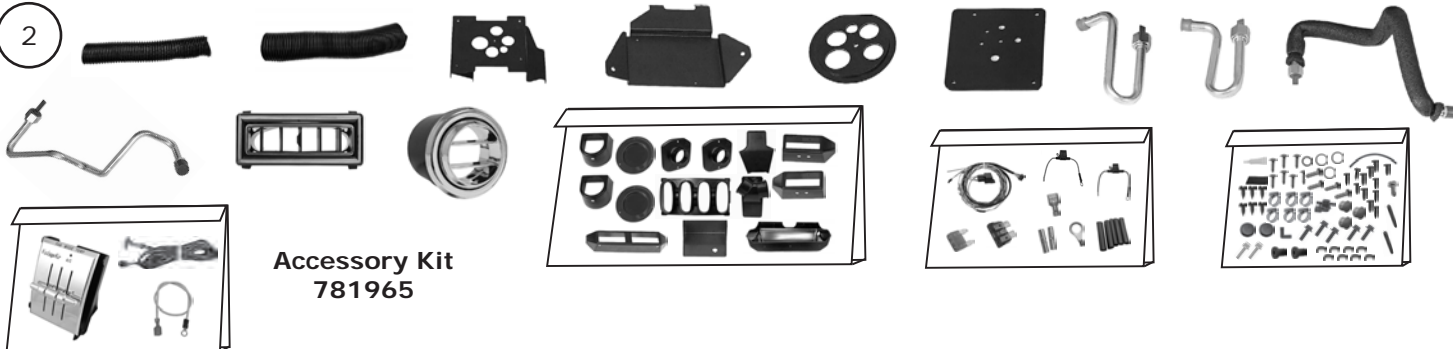

Accessory Kit  
781965

**NOTE: Images may not depict actual parts and quantities. Refer to packing list for actual parts and quantities.**



www.vintageair.com

## Important Notice—Please Read

*For Maximum System Performance, Vintage Air Recommends the Following:*

**NOTE:** Vintage Air systems are designed to operate with R134a refrigerant only. Use of any other refrigerant could damage your A/C system and/or vehicle, and possibly cause a fire, in addition to potentially voiding the warranties of the A/C system and its components.

### Refrigerant Capacities:

**Vintage Air System:** 1.8 lbs. (28.8 oz.) or 816 grams of **R134a**, charged by weight with a quality charging station or scale. **NOTE: Use of the proper type and amount of refrigerant is critical to system operation and performance.**

**Other Systems:** Consult manufacturer's guidelines.

### Lubricant Capacities:

**New Vintage Air-Supplied Sanden Compressor:** No additional oil needed (Compressor is shipped with proper oil charge).

**All Other Compressors:** Consult manufacturer (Some compressors are shipped dry and will need oil added).

### Safety Switches

Your Vintage Air system is equipped with a binary pressure safety switch. A binary switch disengages the compressor clutch in cases of extreme low pressure conditions (refrigerant loss) or excessively high head pressure (406 PSI) to prevent compressor damage or hose rupture. A trinary switch combines Hi/Lo pressure protection with an electric fan operation signal at 254 PSI, and should be substituted for use with electric fans. Compressor safety switches are extremely important since an A/C system relies on refrigerant to circulate lubricant.

### Service Info:

**Protect Your Investment:** Prior to assembly, it is critical that the compressor, evaporator, A/C hoses and fittings, hardlines, condenser and receiver/drier remain capped. Removing caps prior to assembly will allow moisture, insects and debris into the components, possibly leading to reduced performance and/or premature failure of your A/C system. This is especially important with the receiver/drier.

Additionally, when caps are removed for assembly, **BE CAREFUL!** Some components are shipped under pressure with dry nitrogen.

**Evacuate the System for 35-45 Minutes:** Ensure that system components (Drier, compressor, evaporator and condenser) are at a temperature of at least 85°F. On a cool day, the components can be heated with a heat gun **or** by running the engine with the heater on before evacuating. Leak check and charge to specifications.

### Bolts Passing Through Cowl and/or Firewall:

To ensure a watertight seal between the passenger compartment and the vehicle exterior, for all bolts passing through the cowl and/or firewall, Vintage Air recommends coating the threads with silicone prior to installation.

### Heater Hose (not included with this kit):

Heater hose may be purchased from Vintage Air (Part#31800-VUD) or your local parts retailer. Routing and required length will vary based on installer preference.





www.vintageair.com

## Important Wiring Notice—Please Read

*Some vehicles may have had some or all of their radio interference capacitors removed. There should be a capacitor found at each of the following locations:*

- 1. On the positive terminal of the ignition coil.**
- 2. If there is a generator, on the armature terminal of the generator.**
- 3. If there is a generator, on the battery terminal of the voltage regulator.**

Most alternators have a capacitor installed internally to eliminate what is called “whining” as the engine is revved. If whining is heard in the radio, or just to be extra cautious, a radio interference capacitor can be added to the battery terminal of the alternator.

It is also important that the battery lead is in good shape and that the ground leads are not compromised. There should be a heavy ground from the battery to the engine block, and additional grounds to the body and chassis.

If these precautions are not observed, it is possible for voltage spikes to be present on the battery leads. These spikes come from ignition systems and charging systems, and from switching some of the vehicle’s other systems on and off. Modern computer-operated equipment can be sensitive to voltage spikes on the power leads, which can cause unexpected resets, strange behavior and/or permanent damage.

Vintage Air strives to harden our products against these types of electrical noise, but there is a point where a vehicle’s electrical system can be degraded so much that nothing can help.

Radio interference capacitors should be available at most auto and truck parts suppliers. They typically are cylindrical in shape, a little over an inch long and a little over a half-inch in diameter, and they have a single lead coming from one end of the cylinder with a terminal on the end of the wire, as well as a mounting clip which is screwed into a good ground on the vehicle. The specific value of the capacitance is not too significant in comparison to ignition capacitors that are matched with the coil to reduce pitting of the points.

- Care must be taken, when installing the compressor lead, not to short it to ground. The compressor lead must not be connected to a condenser fan or to any other auxiliary device. Shorting to ground or connecting to a condenser fan or any other auxiliary device may damage wiring or the compressor relay, and/or cause a malfunction.
- When installing ground leads on Gen 5 systems, the blower control ground and ECU ground must be connected directly to the negative battery post.
- For proper system operation, the heater control valve must be connected to the ECU.



www.vintageair.com

## Under Dash Louver Information—Please Read

To ensure maximum performance, your 1964 ½-66 Ford Mustang Vintage Air SureFit system includes provisions for under dash louvers.

**A. Center Rectangle Louvers and Side Round Louvers (Included) (Vehicles without OEM center console):** Figure 1, Top, Page 23, and Page 24.

**B. Center Rectangle Louvers and Side Round Louvers (Included) (Vehicles with OEM center console):** Figure 1, Bottom, Page 23, and Page 24.

**C. OPTIONAL UPGRADE—Factory Air-Style Center Louver (not included with kit):**

This configuration features four center louver vents mounted under the dash with two trim options.

1. 620007 - Brushed Heritage Pod Louver Assembly
2. 620008 - Turned Heritage Pod Louver Assembly

**NOTE: This configuration will not fit vehicles with OEM center console. For more details about this kit refer to the website.**





www.vintageair.com

## Engine Compartment Disassembly

**NOTE:** Before starting the installation, check the function of the vehicle (horn, lights, etc.) for proper operation, and study the instructions, illustrations, photos & diagrams.

**Perform the following:**

1. Disconnect the battery.
2. Remove the battery (retain).
3. Drain the radiator.
4. Remove the radiator (retain).
5. Evacuate the A/C system (if necessary).
6. Remove the OEM condenser and drier (discard) (See Figure 1, below).
7. Remove the OEM compressor and bracket (discard) (See Figure 1, below).
8. Remove the OEM heater & A/C hoses (discard) (See Figure 1, below).

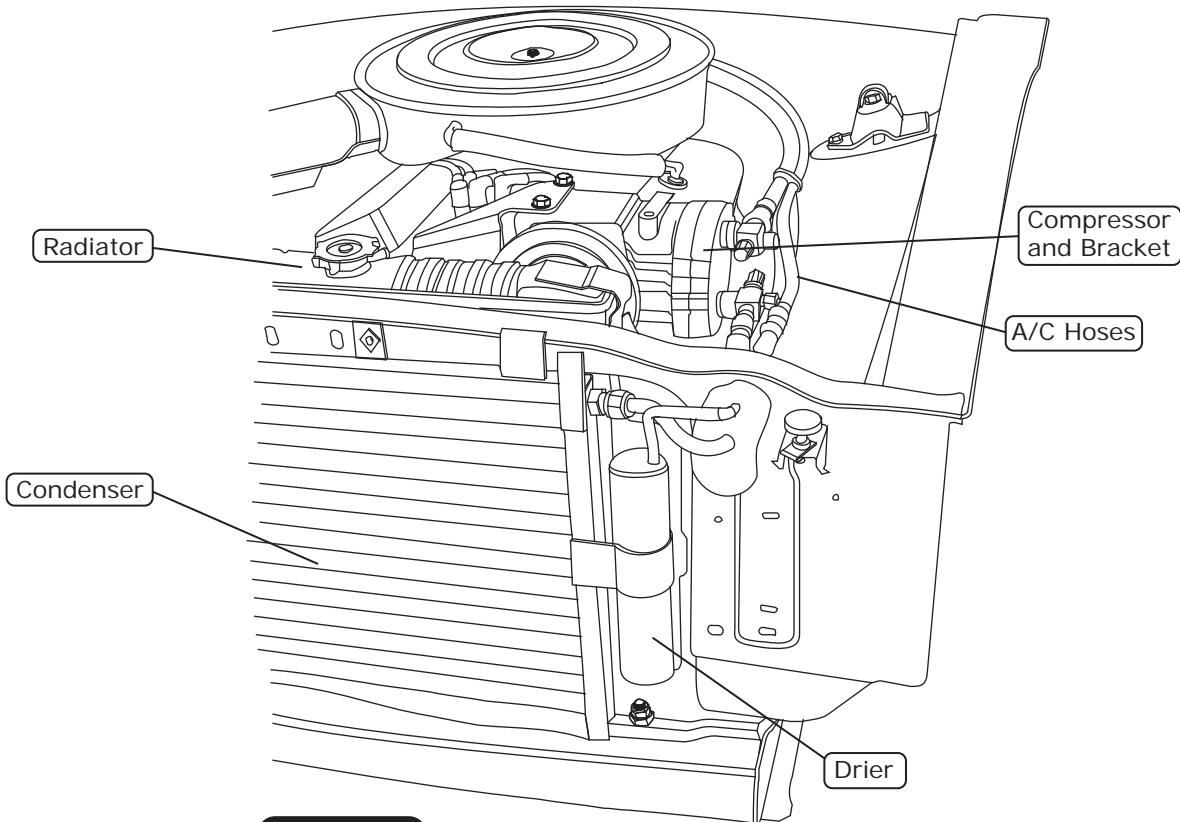

**Figure 1**

## Condenser Assembly and Installation

1. Refer to separate instructions included with the condenser kit to install the condenser.
2. Binary switch installation (Refer to condenser instructions).

## Compressor and Brackets

1. Refer to separate instructions included with the bracket kit to install the compressor bracket.



www.vintageair.com

## Passenger Compartment Disassembly

### Perform the following:

1. Remove the glove box door (retain) (See Figure 1, below).
2. Remove the glove box (discard).
3. Remove the center console (if equipped).
4. Remove the under dash A/C evaporator (if equipped) (See Figure 1, below).
5. Remove the OEM heater assembly (discard) (See Figure 1a, below).
6. Remove the driver-side fresh air assembly and cable (discard) (See Figure 1a, below).
7. Remove the OEM control panel assembly (retain) (See Figure 1a, below). **NOTE: Refer to control panel conversion kit instructions for installation of controls.**
8. Remove the radio (retain).
9. Remove the speaker grille (retain) (See Figure 1a, below).
10. Remove the OEM defrost ducts and all related ducting (See Figure 1a, below).

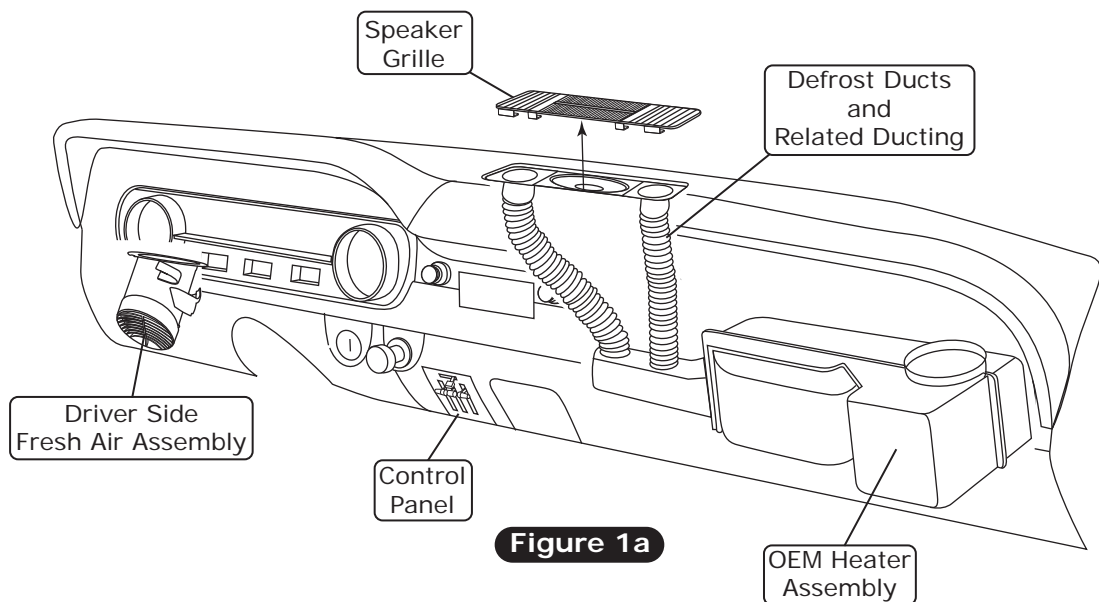
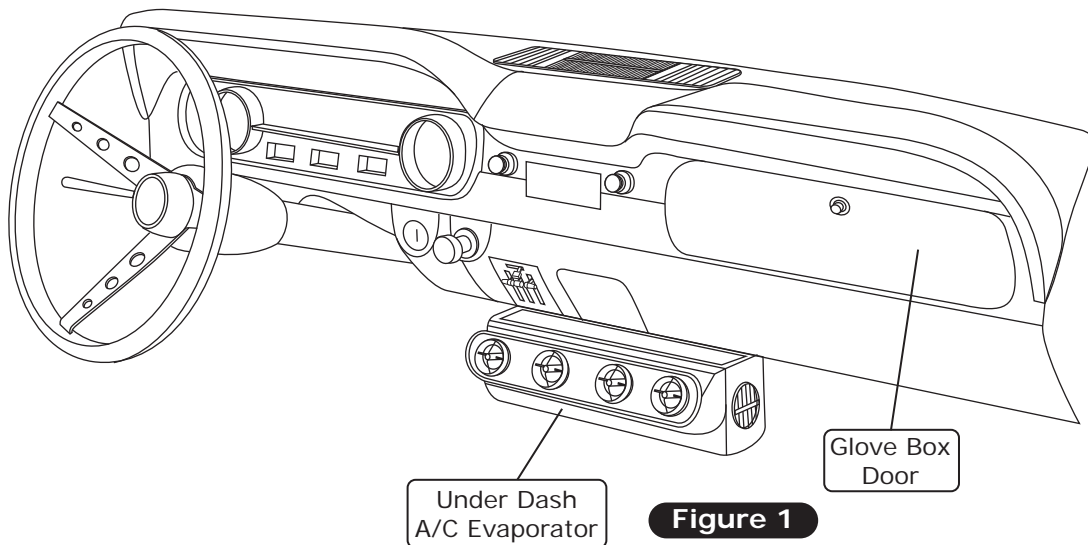





www.vintageair.com

## Firewall Modification and Insulation

**NOTE:** The firewall requires modification for the drain hose to be installed. For proper system operation, Vintage Air recommends using heat-blocking insulation in the area around the evaporator unit (firewall, kick panel, inner cowl, firewall covers). Due to tight clearance for the evaporator unit between the firewall and dash, Vintage Air recommends an insulation thickness of no more than 1/4". Vintage Air recommends using Dynaliner #461501-VIP. To ensure a watertight seal between the passenger compartment and the vehicle exterior, for all bolts passing through the firewall, Vintage Air recommends coating the threads with silicone prior to installation.

Perform the following:

1. Using the bottom-left OEM mounting hole, measure 2 1/2" down and 1 1/2" to the right. Mark and drill a 5/8" hole for the drain tube (See Photos 1 and 2, below). **NOTE: To ensure a tight fit for the drain hose, do not enlarge the drain hole more than 5/8". Install heat-blocking insulation onto the firewall at this time.**
2. From the engine compartment, install (2) 1" plastic plugs into the OEM heater hose exits on the firewall (See Photo 3, below).

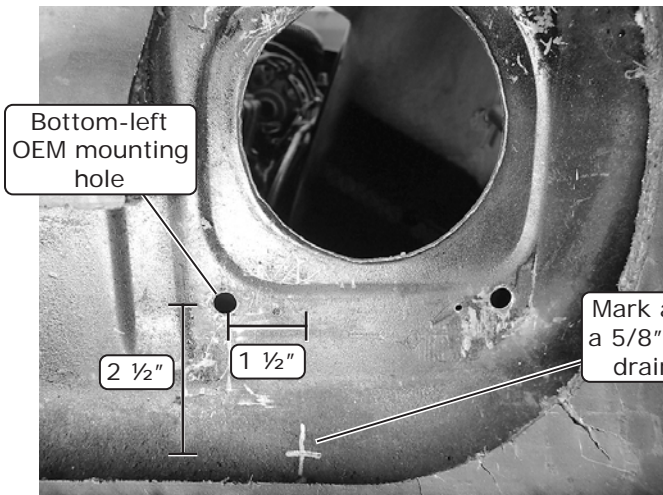

Photo 1



Photo 2

From engine compartment, install (2) 1" plastic plugs into OEM heater hose exits on firewall

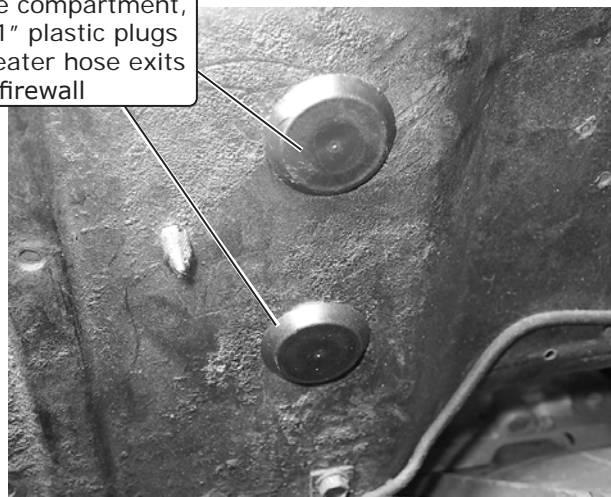

Photo 3



www.vintageair.com

## Defrost Duct and Fresh Air Cap Installation

1. Install the defrost ducts into the dash using the OEM mounting clips (See Figure 3, below).
2. Reinstall the speaker grille (See Figure 3, below).
3. Hold the fresh air cap under the dash, then mark the (3) mounting holes (passenger side only).
4. Drill (3) 1/8" mounting holes under the dash (passenger side only) (See Figure 3, below).
5. Apply a 1/4" bead of silicone around the mating surface of the passenger-side fresh air cap (See Figure 3, below).
6. Secure the passenger-side fresh air cap to the fresh air hole using (3) #10 x 1/2" sheet metal screws as shown in Figure 3, below.
7. Apply a 1/4" bead of silicone around the mating surface of the driver-side fresh air cap (See Figure 3, below).
8. Install the driver-side fresh air cap using (3) OEM nuts as shown in Figure 3, below.

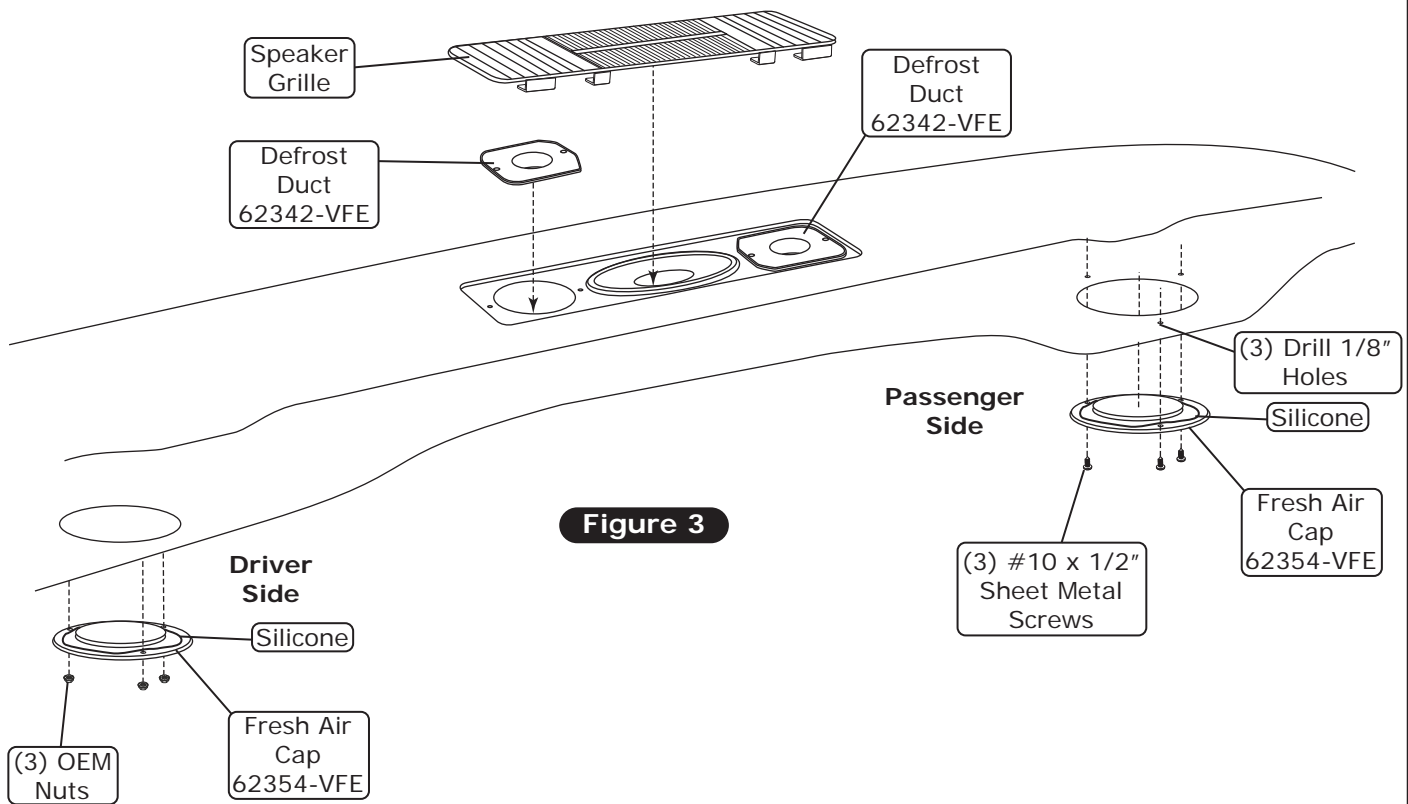
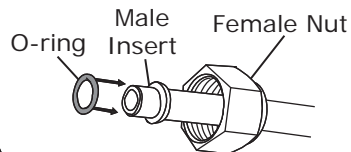
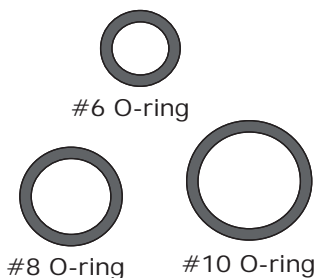

Figure 3

## Lubricating O-rings



For a proper seal of fittings: Install supplied O-rings as shown and lubricate with refrigerant oil.

Refrigerant Oil for O-rings

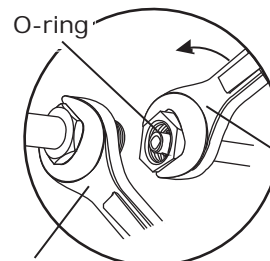
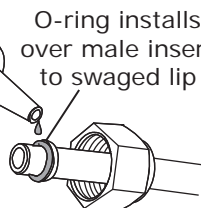

Twist with this wrench

Hold with this wrench

**NOTE: Standard torque specifications:**  
 #6: 11 to 13 ft.-lb.  
 #8: 15 to 20 ft.-lb.  
 #10: 21 to 27 ft.-lb.





www.vintageair.com

# Evaporator Preparation

Perform the following on a workbench:

1. Install (3) 1/2" plastic plugs into the back of the evaporator module (See Photos 1, 2, 3 and 4, below).
2. With a properly lubricated #6 O-ring, (See Lubricating O-rings, Page 10), loosely install the #6 liquid hardline onto the #6 fitting on the block valve adapter (See Photo 5, below).
3. With a properly lubricated #10 O-ring, (See Lubricating O-rings, Page 10), loosely install the lower heater hardline onto the lower heater fitting (See Photo 6, below).
4. With a properly lubricated #10 O-ring, (See Lubricating O-rings, Page 10), loosely install the upper heater hardline onto the upper heater fitting (See Photo 7, below).
5. With a properly lubricated #10 O-ring, (See Lubricating O-rings, Page 10), loosely install the #10 suction hardline onto the #10 fitting on the block valve adapter (See Photo 8, below).

Install 1/2" plastic plug into back of evaporator unit

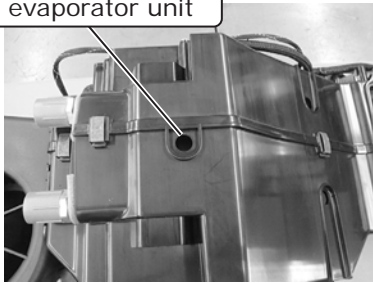

Photo 1

1/2" plastic plug



Photo 2

Install (2) 1/2" plastic plugs

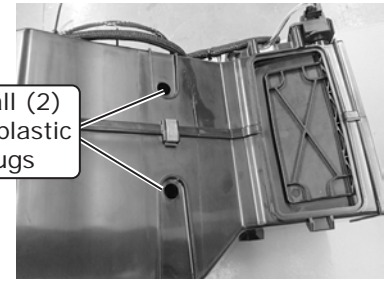

Photo 3

(2) 1/2" plastic plugs

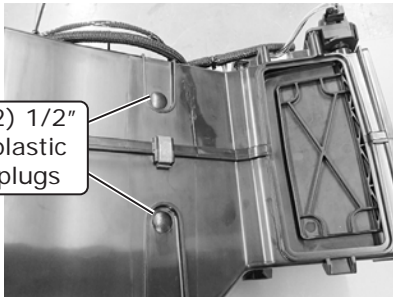
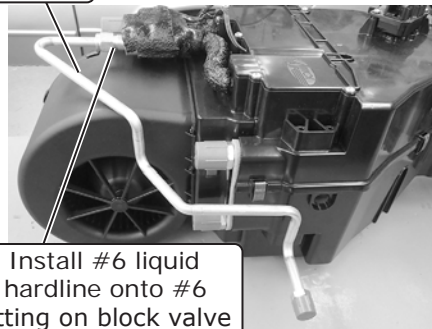

Photo 4

#6 Liquid Hardline 081967



Install #6 liquid hardline onto #6 fitting on block valve

Photo 5

Lower Heater Hardline 081965

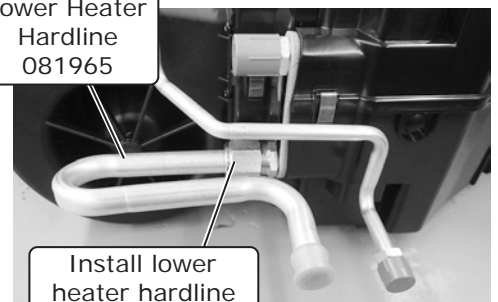

Install lower heater hardline onto lower heater fitting

Photo 6

Upper Heater Hardline 081964

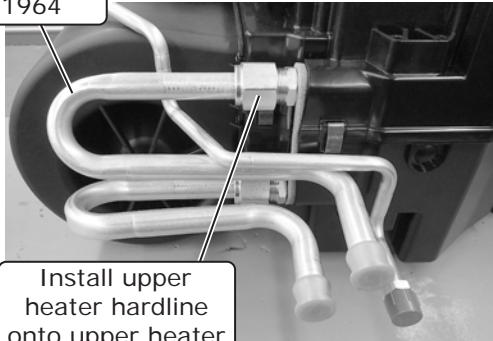

Install upper heater hardline onto upper heater fitting

Photo 7

#10 Suction Hardline 081966

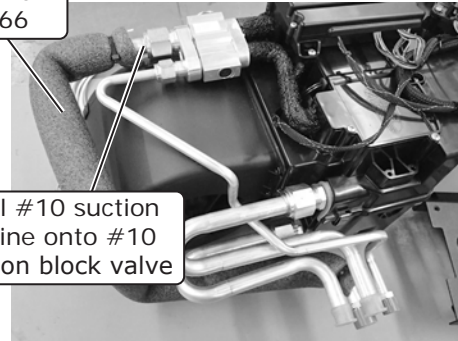

Install #10 suction hardline onto #10 fitting on block valve

Photo 8

## Evaporator Preparation (Cont.)

6. Place the evaporator firewall bracket over the evaporator hardlines, and adjust the hardlines so each hardline is centered in the bracket (See Photo 9, below). Remove the firewall bracket, then tighten the hardlines.
7. Wrap all exposed metal at the block fitting adapter of the #10 suction hardline with press tape (See Photos 10 and 11, below).
8. Route the heater control valve connector and wiring through the wiring opening on the firewall bracket (See Photo 12, below).
9. Install the firewall bracket onto the rear of the evaporator case and secure it using (4) #10 x 5/8" screws (See Photos 12, 13, 14 and 15, below).

Install evaporator firewall bracket over evaporator hardlines

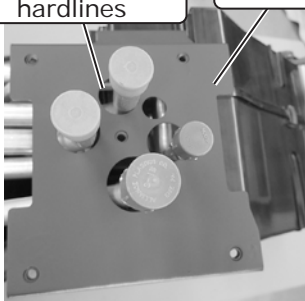

Photo 9

Evaporator Firewall Bracket 641963



Photo 10

Wrap all exposed metal at block fitting of #10 suction hardline with press tape

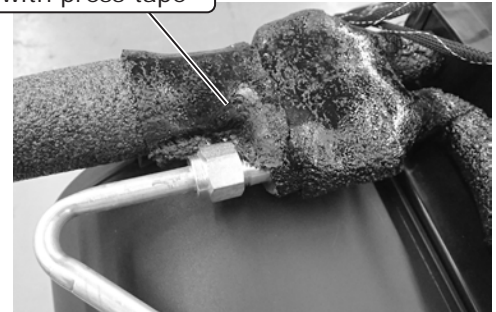

Photo 11

Install firewall bracket onto rear of evaporator case

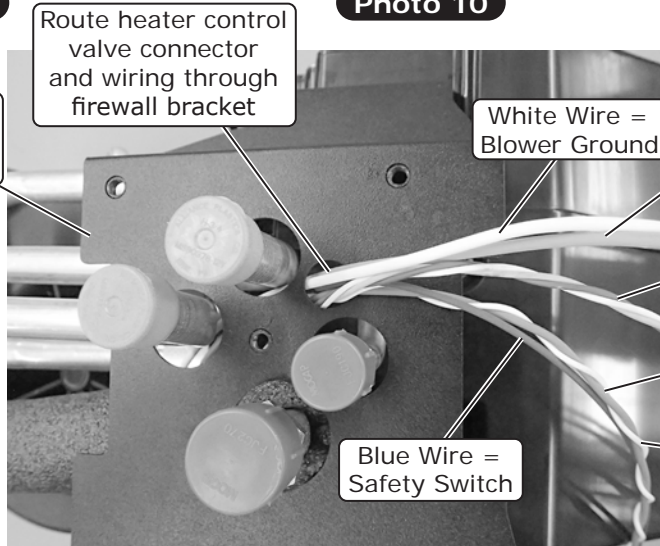

Photo 12

Route heater control valve connector and wiring through firewall bracket

White Wire = Blower Ground

Orange Wire = Blower Power

White, Yellow, Purple Wires = Heater Control Wiring

Red Wire = ECU Power

Blue Wire = Safety Switch

White Wire = ECU Ground

Install firewall bracket onto rear of evaporator case



Photo 13

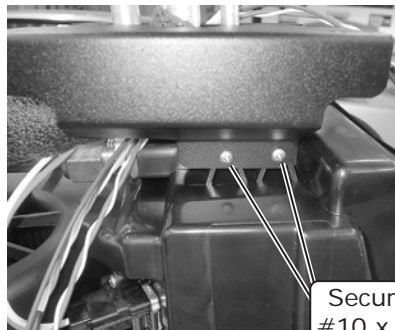

Photo 14

Secure using (4) #10 x 5/8" screws

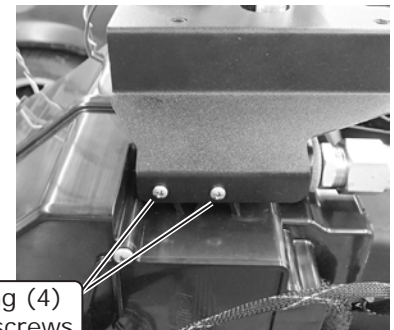

Photo 15



www.vintageair.com

## Evaporator Preparation (Cont.)

10. Route the heater control valve connector and wiring through the firewall bracket rubber boot, then install it over the evaporator hardlines (See Photos 16 and 17, below).
11. Install (2) 1/4-20 x 1 1/2" full-length studs into the top mounting holes of the evaporator mounting bracket (See Photo 18, below).
12. Using (2) spring clips, install the floor plenum onto the back of the evaporator module (See Photos 19 and 20, below).
13. Using (4) spring clips, install the dash plenum (See Photos 21, 22 and 23, below).

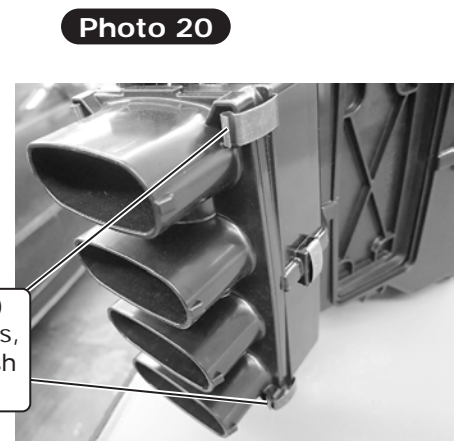
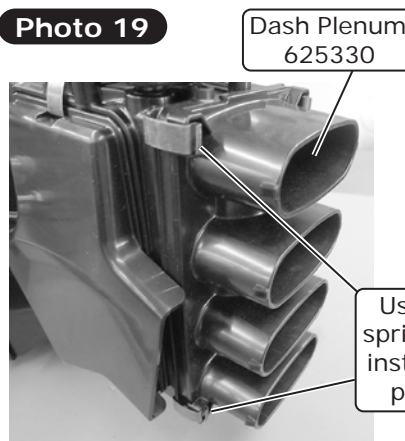
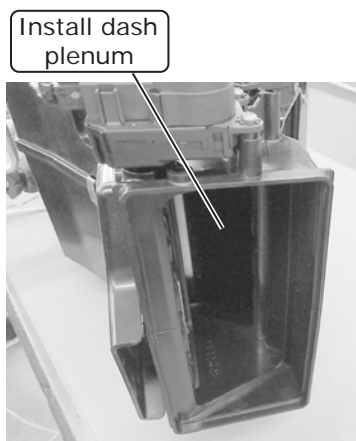
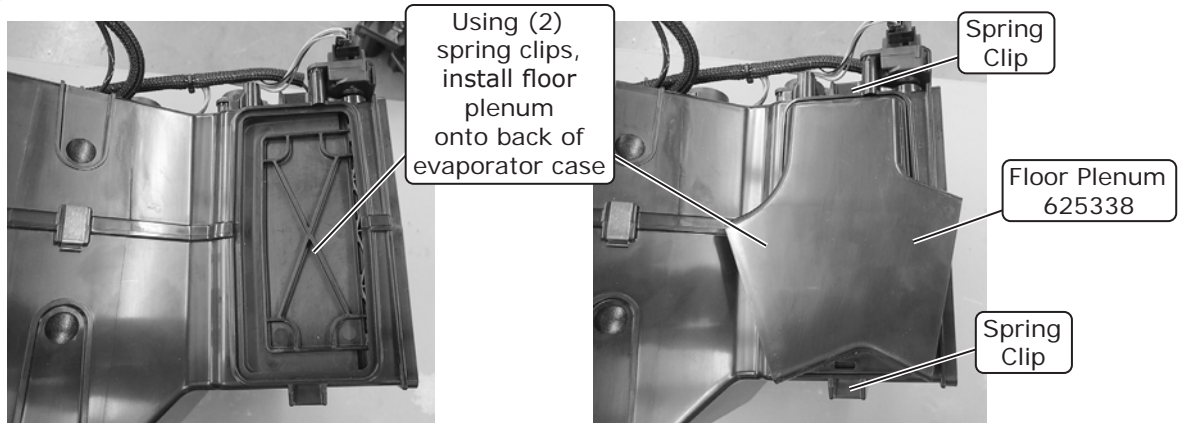
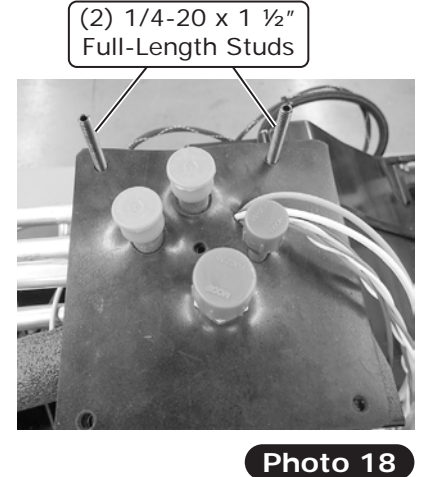
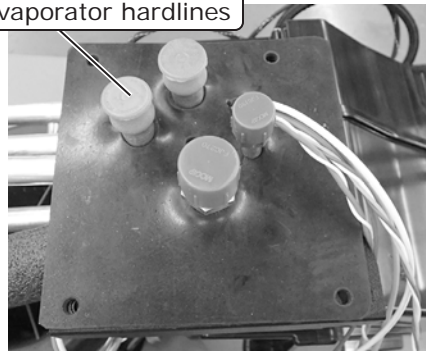
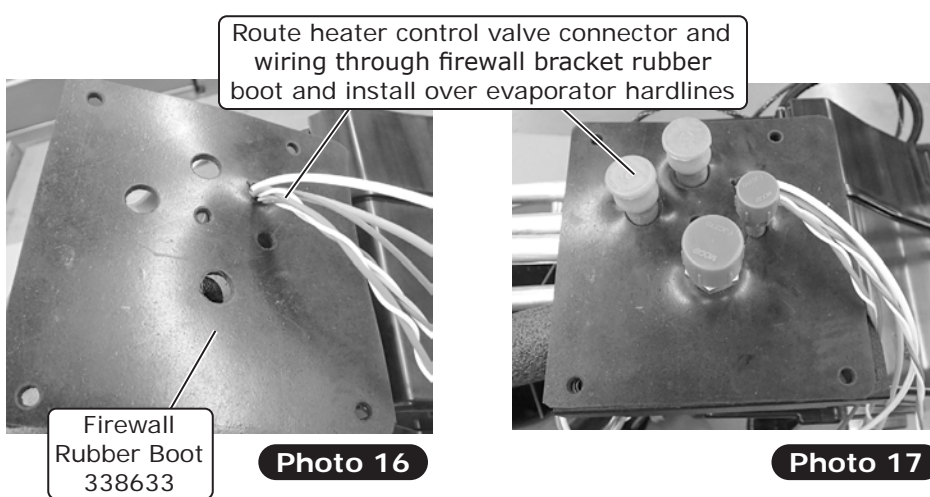





www.vintageair.com

## Evaporator Preparation (Final)

- Using (2) spring clips, install the defrost plenum onto the front of the evaporator module (See Photos 24 and 25, below).
- Loosen the (2) screws holding the ECU (See Photo 26, below), then remove it and let it hang in front of the unit. Retighten the mounting screws.

Install defrost plenum onto front of evaporator module

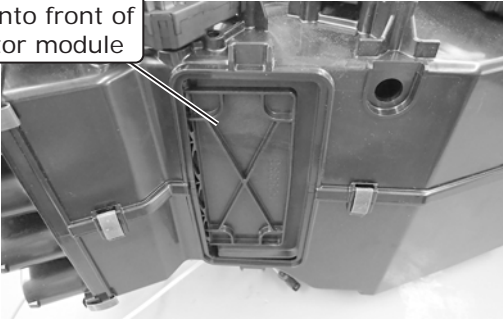
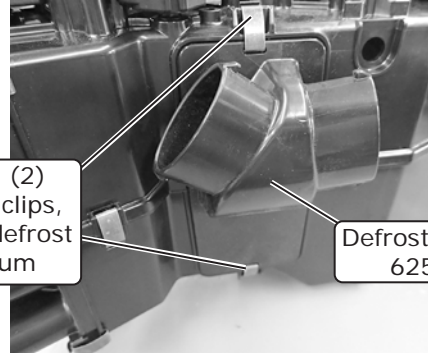

Photo 24

Using (2) spring clips, install defrost plenum



Defrost Plenum 625331

Photo 25

Loosen (2) screws holding the ECU



Photo 26

## Evaporator Installation (Passenger Compartment)

- Place the evaporator unit on the passenger-side floorboard.
- Route the heater control valve connector and wiring into the engine compartment through the large opening.
- Lift the evaporator unit into position, using the (2) 1/4-20 x 1 1/2" full-length studs to locate the correct mounting position (See Photo 1, below).
- Install (2) 1/4-20 well nuts into the front mounting locations (See Photos 2 and 3, below).

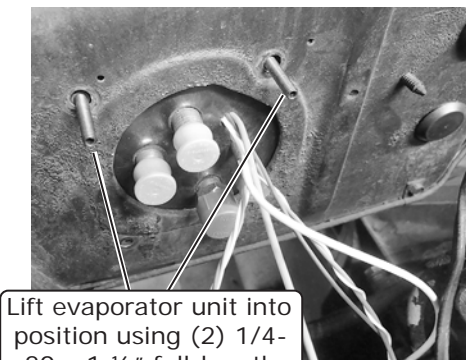

Lift evaporator unit into position using (2) 1/4-20 x 1 1/2" full-length studs to locate correct mounting position

Photo 1

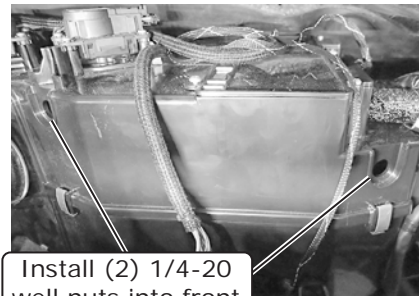

Install (2) 1/4-20 well nuts into front mounting locations

Photo 2

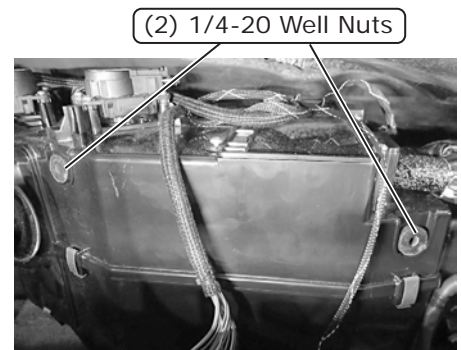

(2) 1/4-20 Well Nuts

Photo 3



www.vintageair.com

## Evaporator Installation (Passenger Compartment) (Cont.)

- Using (2) 1/4-20 x 3/4" serrated flange bolts, install the evaporator dash bracket (See Photo 4, below).
- Lift unit into position. Using the dash mounting bracket as a template, mark and drill (2) pilot holes into the cowl. Coat (2) #10 x 1/2" sheet metal screws with silicone, and secure the bracket into the cowl (See Photo 5, below).
- Use (2) #6 phillips screws to secure the ECU to the dash bracket (See Photo 6, below).

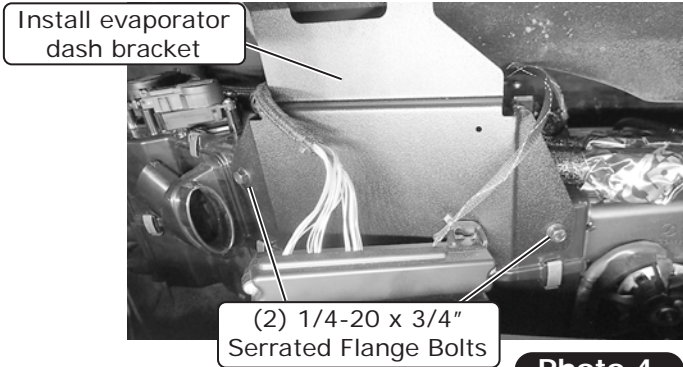

Photo 4

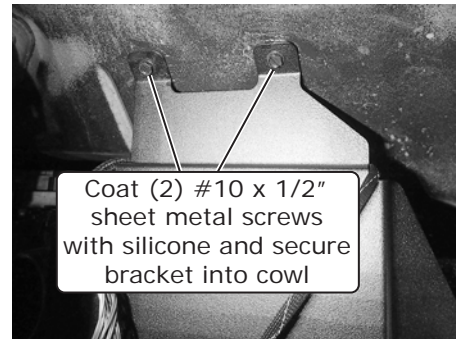

Photo 5

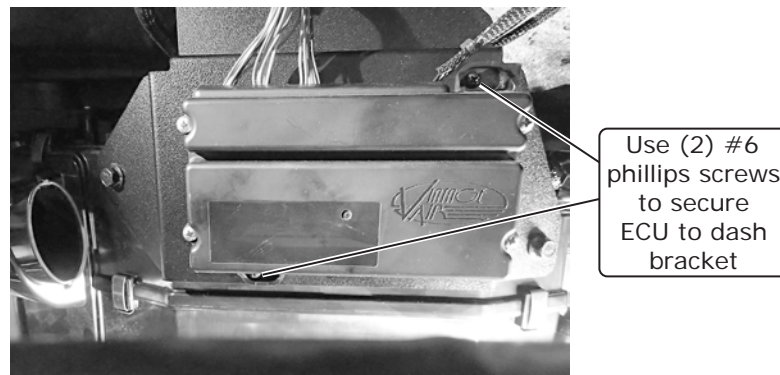

Photo 6

## Evaporator Installation (Engine Compartment)

- Apply silicone to the mating surface of the firewall cover (See Photo 1, below).
- Route the heater control valve plug and wiring through the firewall cover, then slide it into position over the hardlines (See Photo 2, below).

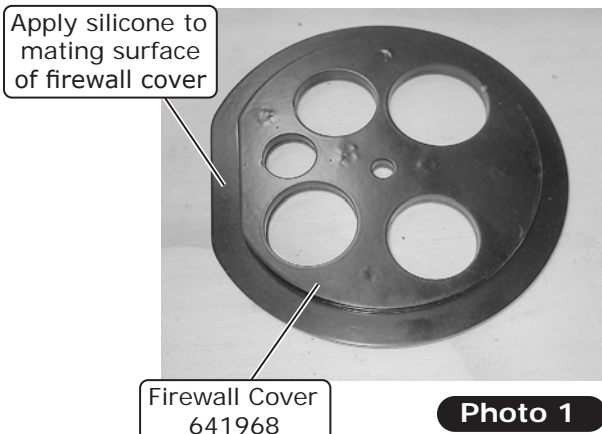

Photo 1

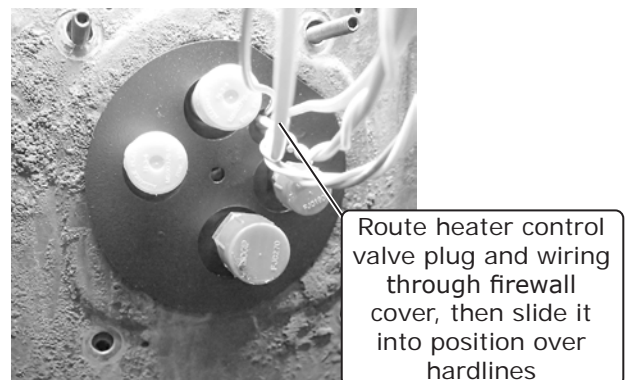

Photo 2



www.vintageair.com

## Evaporator Installation (Engine Compartment) (Cont.)

- Loosely secure the firewall cover to the evaporator firewall bracket using a 1/4-20 x 3/4" hex washer bolt (See Photo 3, below).
- Loosely install (2) 1/4-20 x 3/4" hex washer bolts into the lower firewall bracket mounting holes on the firewall (See Photo 4, below). Remove the (2) 1/4-20 x 1 1/2" full-length studs and replace them with (2) 1/4-20 x 3/4" hex washer bolts (See Photo 4, below).
- Tighten all mounting hardware at this time.

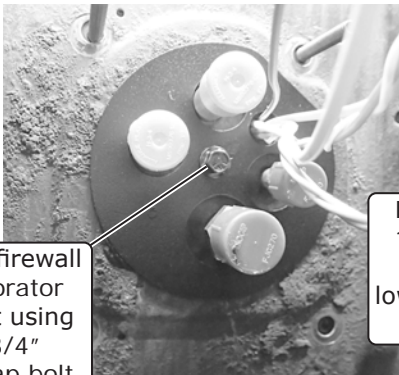

Loosely secure firewall cover to evaporator firewall bracket using a 1/4-20 x 3/4" serrated hex cap bolt

Photo 3

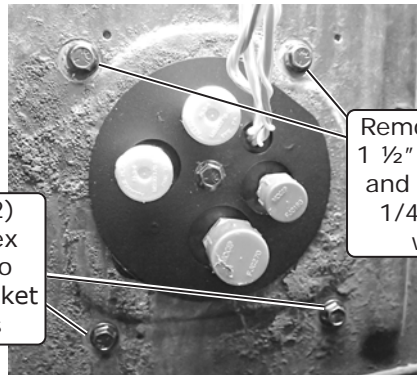

Loosely install (2) 1/4-20 x 3/4" hex washer bolts into lower firewall bracket mounting holes

Remove (2) 1/4-20 x 1 1/2" full-length studs and replace with (2) 1/4-20 x 3/4" hex washer bolts

Photo 4

## Drain Hose Installation

- Cut the drain hose approximately 8". Install the drain elbow onto the remaining piece of hose (See Photo 1, below).
- Install the 8" piece of drain hose onto the evaporator drain at the bottom of the module, then route it through the 5/8" drain hole in the firewall (See Photo 2, below).
- In the engine compartment, connect the drain elbow to the drain hose (See Photo 3, below). **NOTE: Route the drain hose away from the exhaust.**

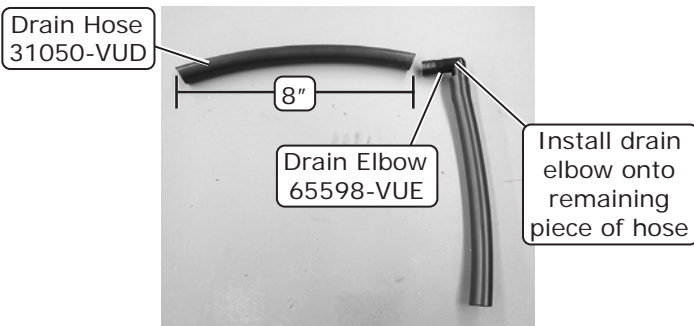

Drain Hose 31050-VUD

8"

Drain Elbow 65598-VUE

Install drain elbow onto remaining piece of hose

Photo 1



Install 8" piece of drain hose onto evaporator drain at bottom of unit and route through 5/8" drain hole in firewall

Photo 2



Connect drain elbow to drain hose

Photo 3





www.vintageair.com

## A/C Hose Installation

### Standard Hose Kit:

1. Locate the #8 compressor A/C hose. Lubricate (2) #8 O-rings (See Lubricating O-rings, Page 10), and connect the 45° fitting to the #8 discharge port on the compressor. Route the straight female fitting with service port to the #8 condenser hardline coming through the radiator core support (See Figure 1, Page 19). Tighten each fitting connection as shown in Lubricating O-rings, Page 10.
2. Locate the #10 compressor A/C hose. Lubricate (2) #10 O-rings (See Lubricating O-rings, Page 10), and connect the 90° female fitting with service port to the #10 suction port on the compressor. Route the 90° female fitting to the #10 evaporator hardline coming through the firewall (See Figure 1, Page 18, & Figure 1, Page 19). Tighten each fitting connection as shown in Lubricating O-rings, Page 10.
3. Locate the #6 evaporator/drier hose. Lubricate (2) #6 O-rings (See Lubricating O-rings, Page 10), and connect the straight female fitting to the #6 drier hardline coming through the radiator core support. Route the 90° female fitting to the #6 evaporator hardline coming through the firewall (See Figure 1, Page 18). Tighten each fitting connection as shown in Lubricating O-rings, Page 10.
4. Use (6) tie wraps to secure the #6 A/C hose to the brace as shown in Figure 1, Page 19.

### Modified Hose Kit:

1. Refer to separate instructions included with modified hose kit.



www.vintageair.com

## Heater Hose & Heater Control Valve Installation

**NOTE:** Vintage Air systems use 5/8" heater connections. On engines equipped with 3/4" hose nipples, these will need to be removed and replaced with 5/8" nipples (not supplied). For water pumps with a cast-in 3/4" heater outlet, a 3/4" x 5/8" reducer fitting (not supplied) or molded hose will need to be installed in the heater hose.

1. Route a length of heater hose from the lower heater hardline to the water pump fitting, then secure it using (2) hose clamps.
2. Cut a length of heater hose approximately 4" to 5" from the firewall cover, then install it onto the upper heater hardline. Install the heater control valve and secure it with (2) hose clamps. **NOTE: Ensure proper flow direction through the heater control valve. The flow direction follows the molded arrow on the valve (See Figure 1, below).**
3. Install another length of heater hose from the heater control valve to the intake, then secure it with (2) hose clamps.
4. Plug the heater control valve connector into the heater control valve connector wiring harness.

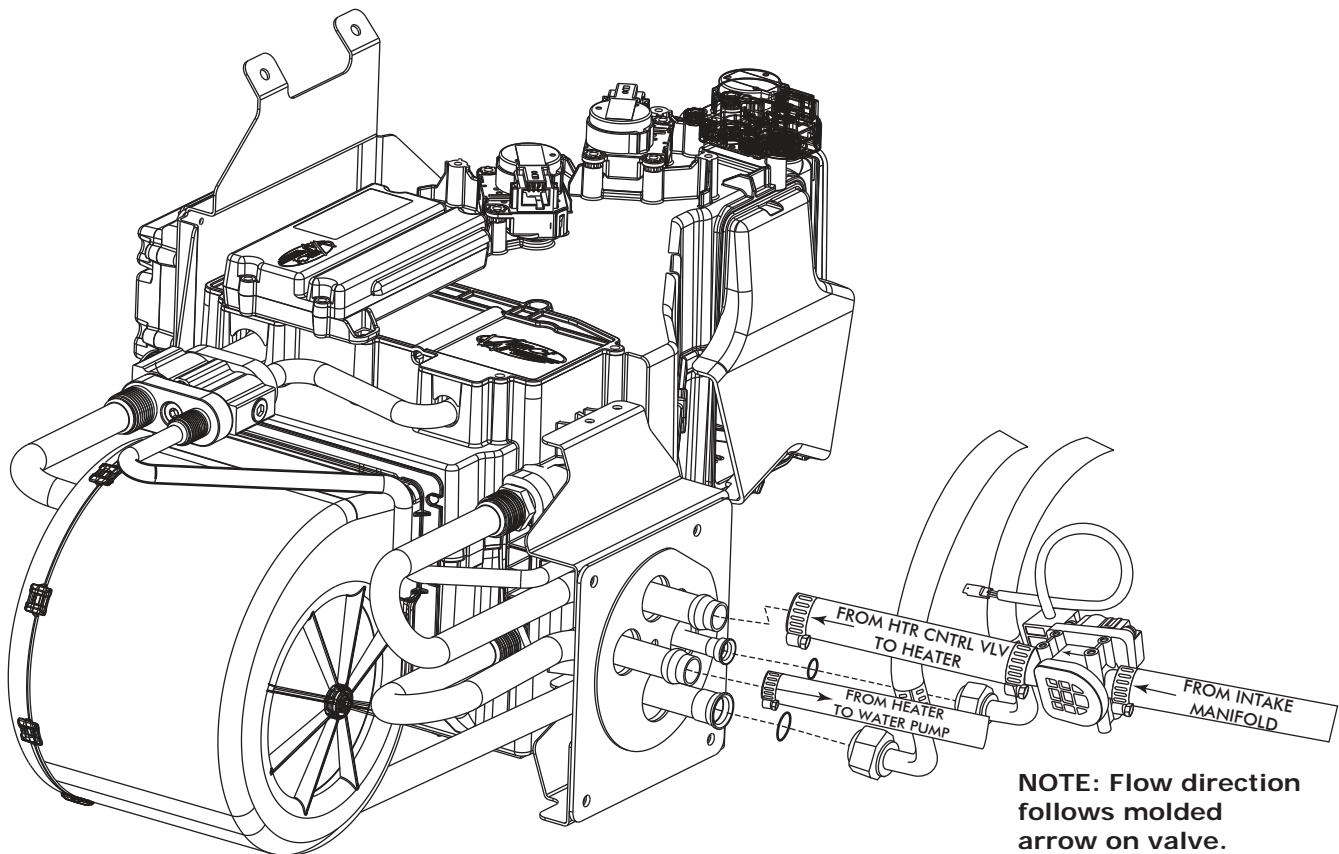

Figure 1



www.vintageair.com

# Driver Side A/C and Heater Hose Routing

NOTE: Vintage Air Systems use 5/8" heater connections. On engines equipped with 3/4" hose nipples, these will need to be removed and replaced with 5/8" nipples (not supplied). For water pumps with a cast-in 3/4" heater outlet, a 3/4" x 5/8" reducer fitting (not supplied) or molded hose will need to be installed in the heater hose.

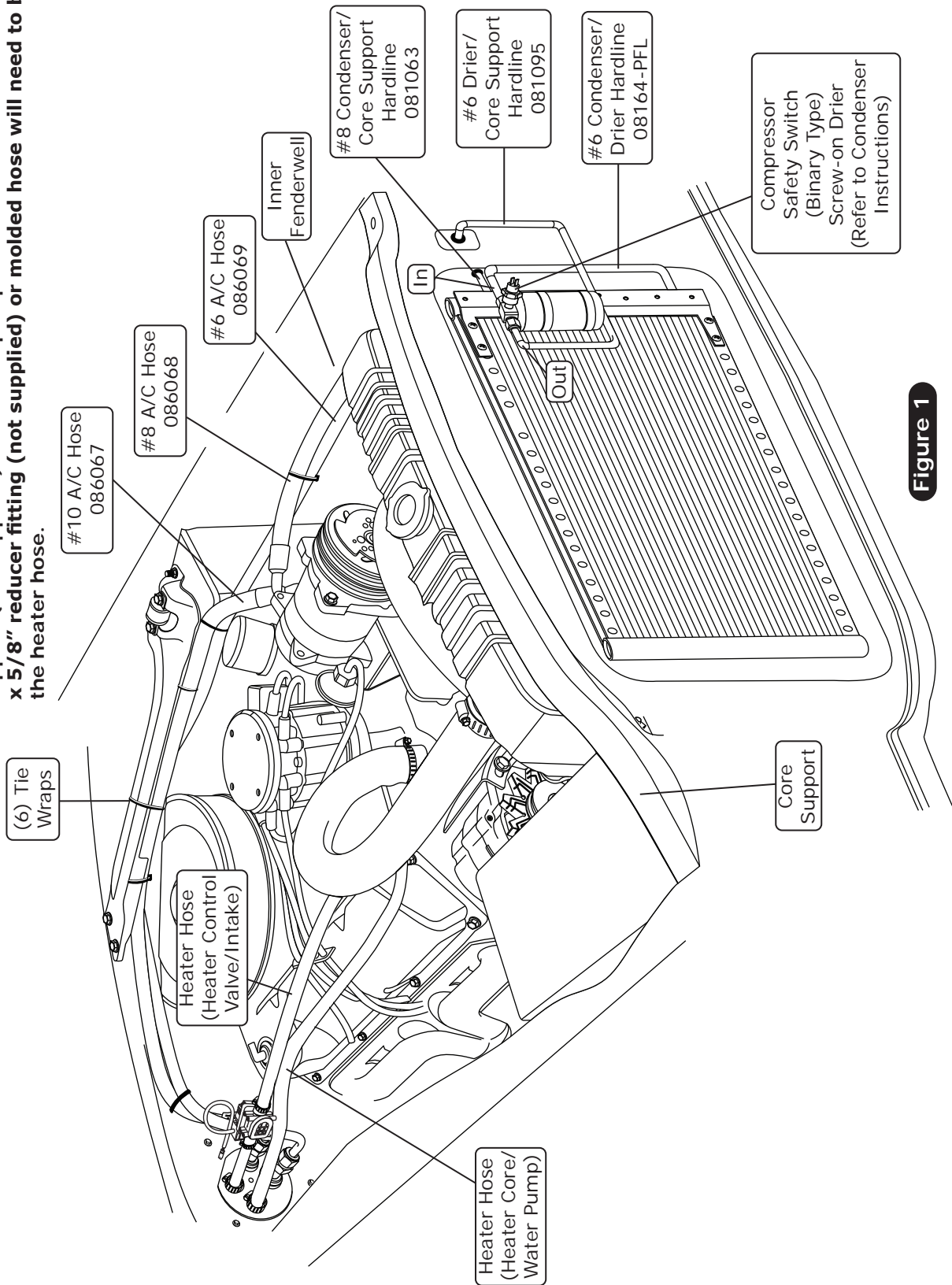

Figure 1



www.vintageair.com

# Passenger Side A/C and Heater Hose Routing

**NOTE:** Vintage Air Systems use 5/8" heater connections. On engines equipped with 3/4" hose nipples, these will need to be removed and replaced with 5/8" nipples (not supplied). For water pumps with a cast-in 3/4" heater outlet, a 3/4" x 5/8" reducer fitting (not supplied) or molded hose will need to be installed in the heater hose.

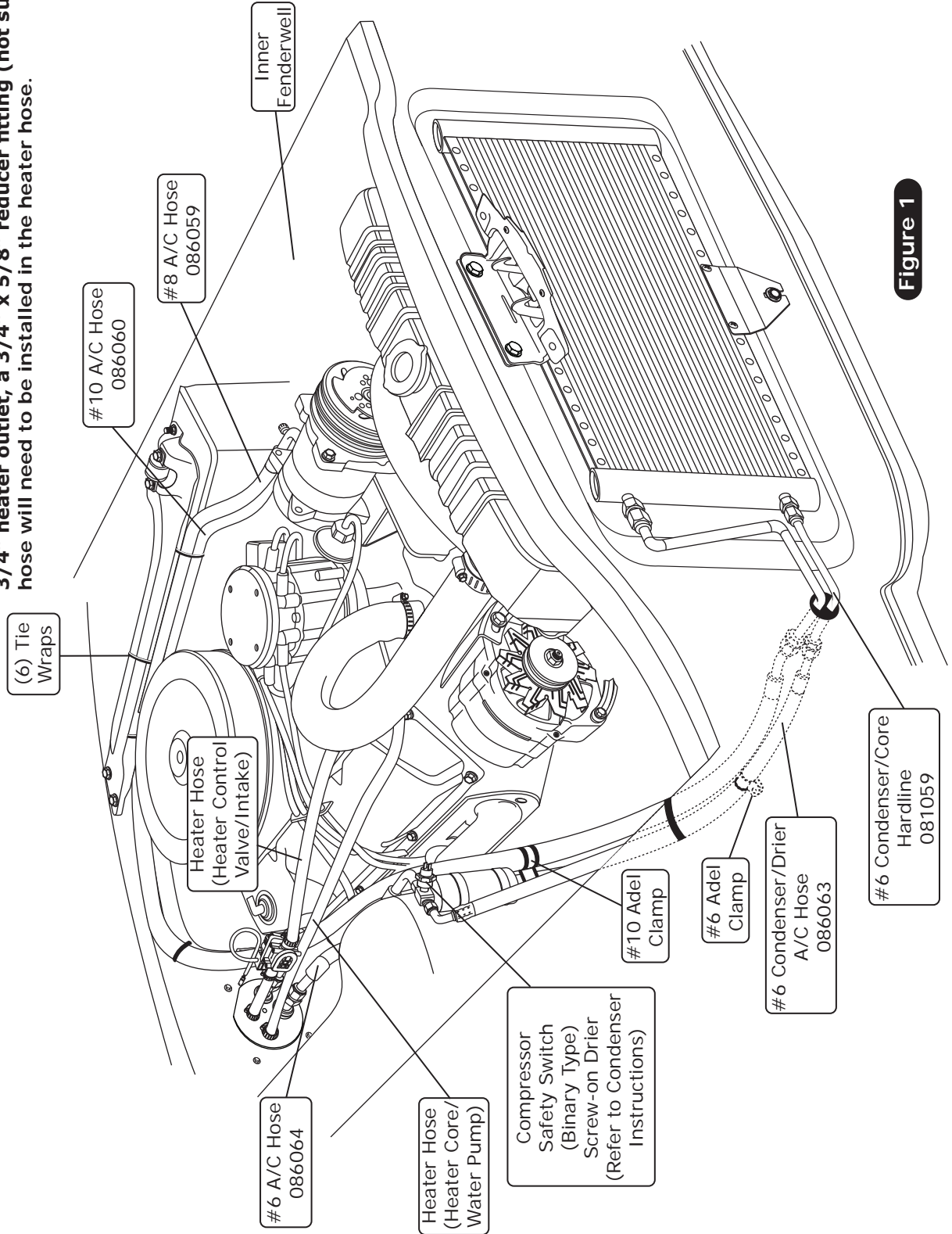

**Figure 1**



www.vintageair.com

## Passenger Compartment Wiring

1. Select a suitable location for the main relay, and secure it using a #10 x 1/2" sheet metal screw. Select a suitable ground location for the white ground wire eyelet from the heater control valve harness, and secure it using a #12 x 1/2" self-tapping screw (See Photo 1, below).
2. Route the violet power wire to a switched 12v power source on the fuse panel (See Photo 2, below).  
**NOTE: This requires a male fuse extension (not supplied).**
3. Connect the tan wire to the factory dash lights to enable control panel backlighting (if applicable).
4. Connect the BSC wiring to the main harness (See Photo 3, below).
5. Connect the main harness to the ECU (See Photo 4, below).

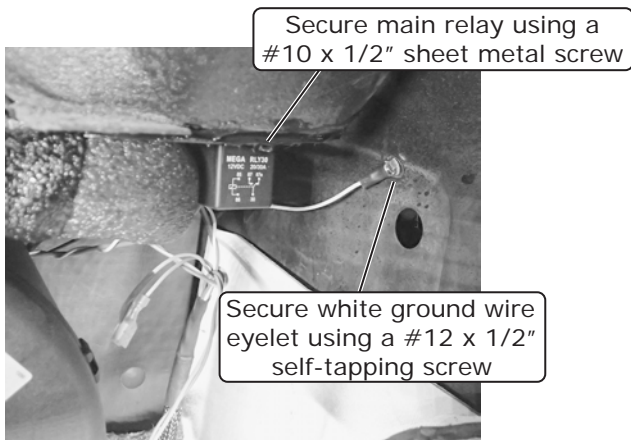

Photo 1

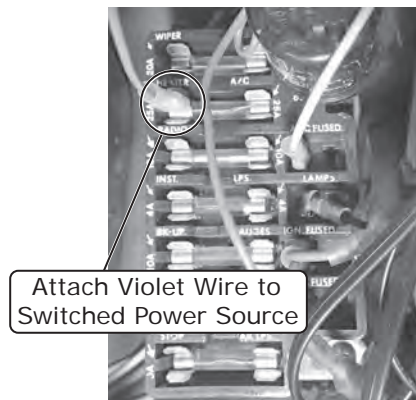

Photo 2

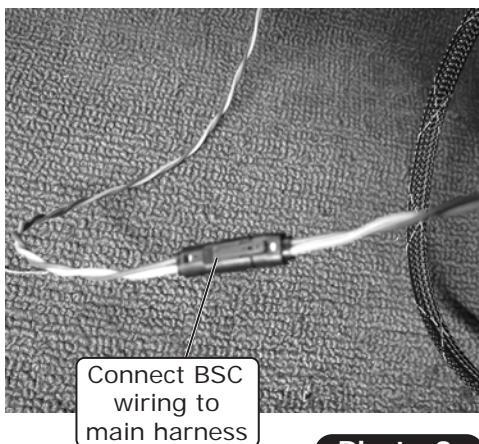

Photo 3

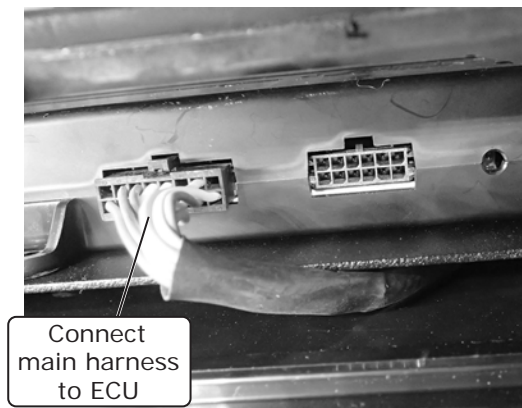

Photo 4





www.vintageair.com

## Engine Compartment Wiring

1. Route power and ground wires toward the battery.
  2. Install the supplied heat shrink over the 12 AWG orange fuse holder assembly wire, and crimp it to the 12 AWG orange wire from the main wiring harness (See Photo 1, below and Quality Crimp Guidelines, Page 28).
  3. Install the supplied heat shrink over the 16 AWG black fuse holder assembly wire, and crimp it to the 16 AWG red wire from the main wiring harness (See Photo 2, below and Quality Crimp Guidelines, Page 28).
  4. Install fuses into the holders (See Photo 3, below).
  5. Install the supplied heat shrink over the white ground wires, then crimp on the supplied eyelets (See Photos 4 and 5, below and Quality Crimp Guidelines, Page 28)
  6. Connect the ground wiring eyelets to the negative battery terminal connector (See Photo 6, below).
  7. Connect the positive wiring eyelets to the positive battery terminal connector (See Photo 7, below).
- NOTE: Do not connect power until installation is completed.**

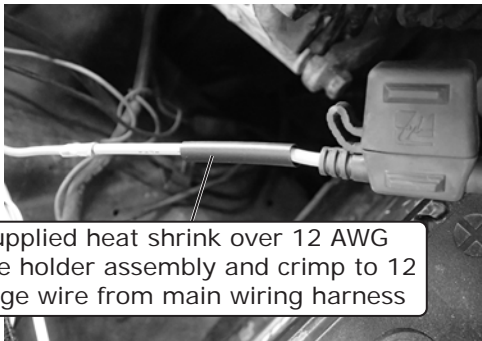

Install supplied heat shrink over 12 AWG orange fuse holder assembly and crimp to 12 AWG orange wire from main wiring harness

Photo 1

Install supplied heat shrink over 16 AWG black fuse holder assembly wire and crimp to 16 AWG red wire from main wiring harness

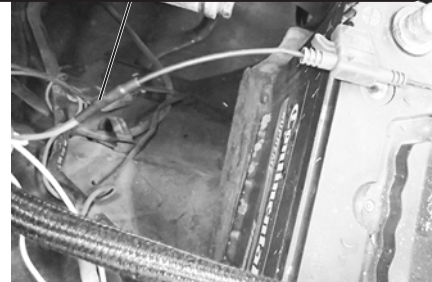

Photo 2

Install fuses into holders

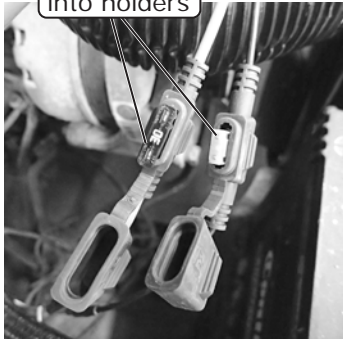

Photo 3

Install supplied heat shrink over white ground wires and crimp on supplied eyelets

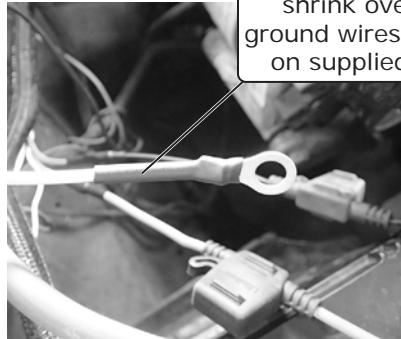

Photo 4

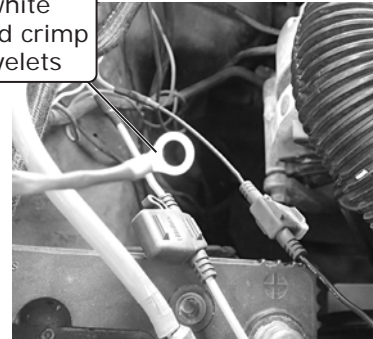

Photo 5

Connect ground wiring eyelets to negative battery terminal connector

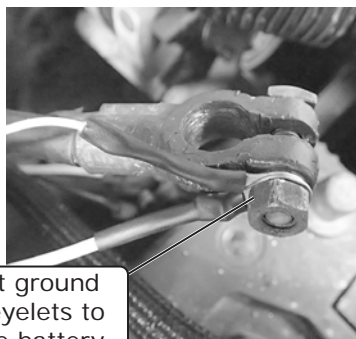

Photo 6

**NOTE: Do not connect power until installation is completed.**

Connect positive wiring eyelets to positive battery terminal connector

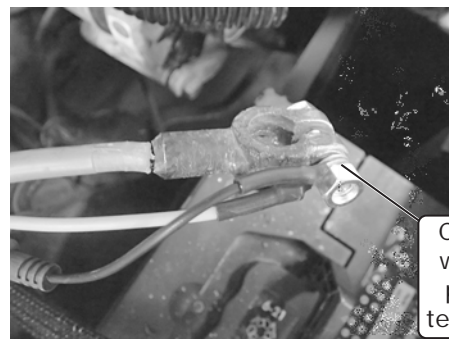

Photo 7





www.vintageair.com

## Center Louver Installation (without Center Console)

1. Mount the center louver bezel under the dash using (2) #8 x 1/2" pan head screws as shown in Figure 1, below.
2. Install the louvers into the center louver bezel as shown in Figure 1, below.

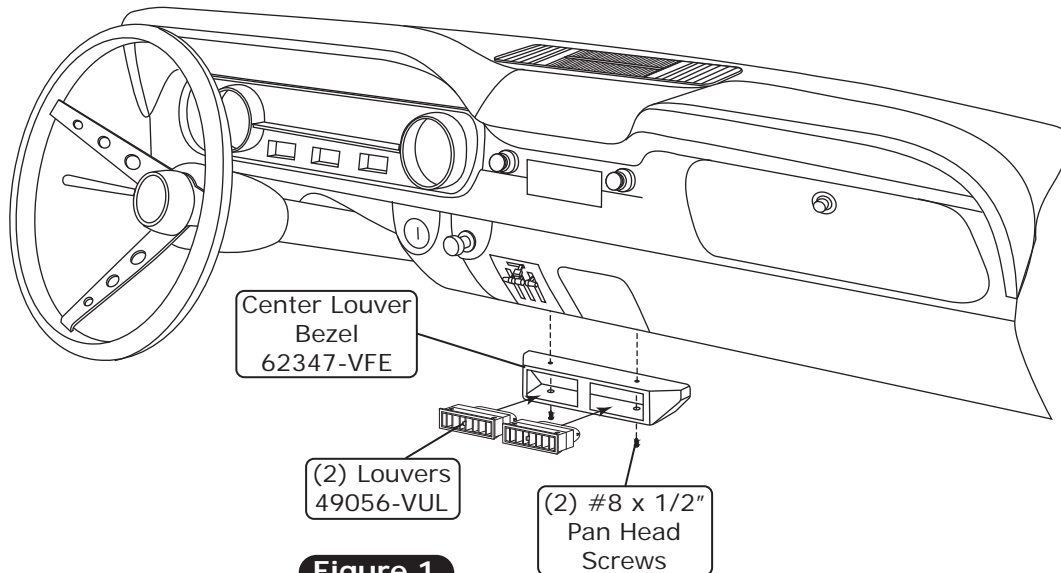

**Figure 1**

## Center Louver Installation (with Center Console)

1. Mount the driver- and passenger-side center louver bezels under the dash using (4) #8 x 1/2" pan head screws as shown in Figure 1, below.
2. Install the louvers into the center louver bezels as shown in Figure 1, below.

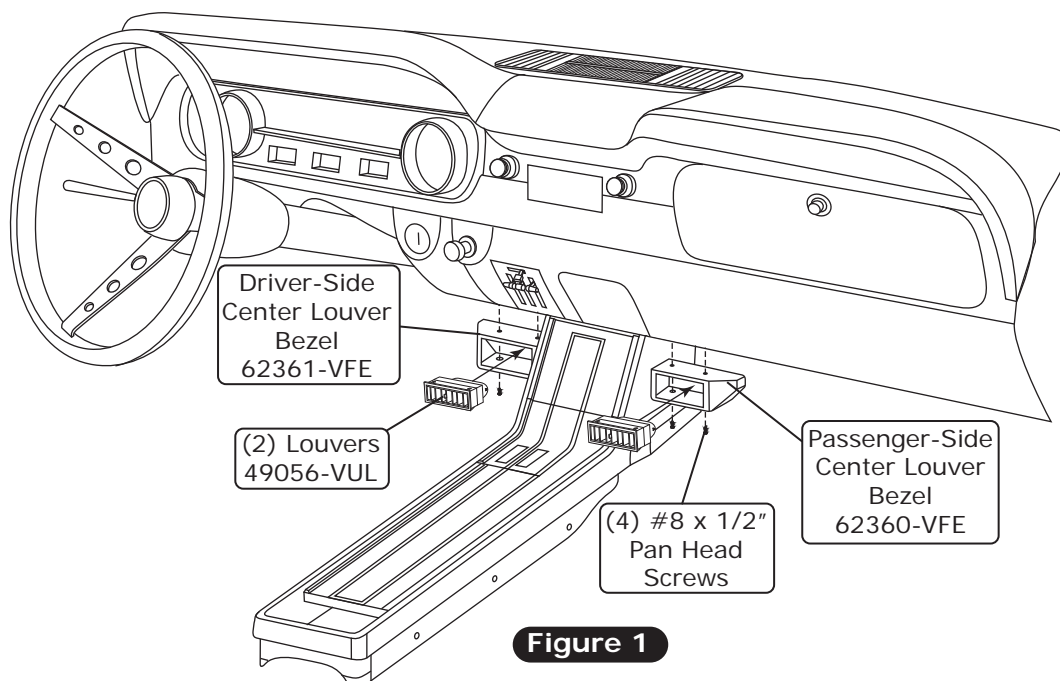

**Figure 1**



www.vintageair.com

## Driver- & Passenger-Side Under Dash Louver Installation

1. Mount the driver- and passenger-side louver housings under the dash using (2) #8 x 1/2" pan head screws as shown in Figure 1, below.
2. Install the louvers into the driver and passenger side louver housings as shown in Figure 1, below.

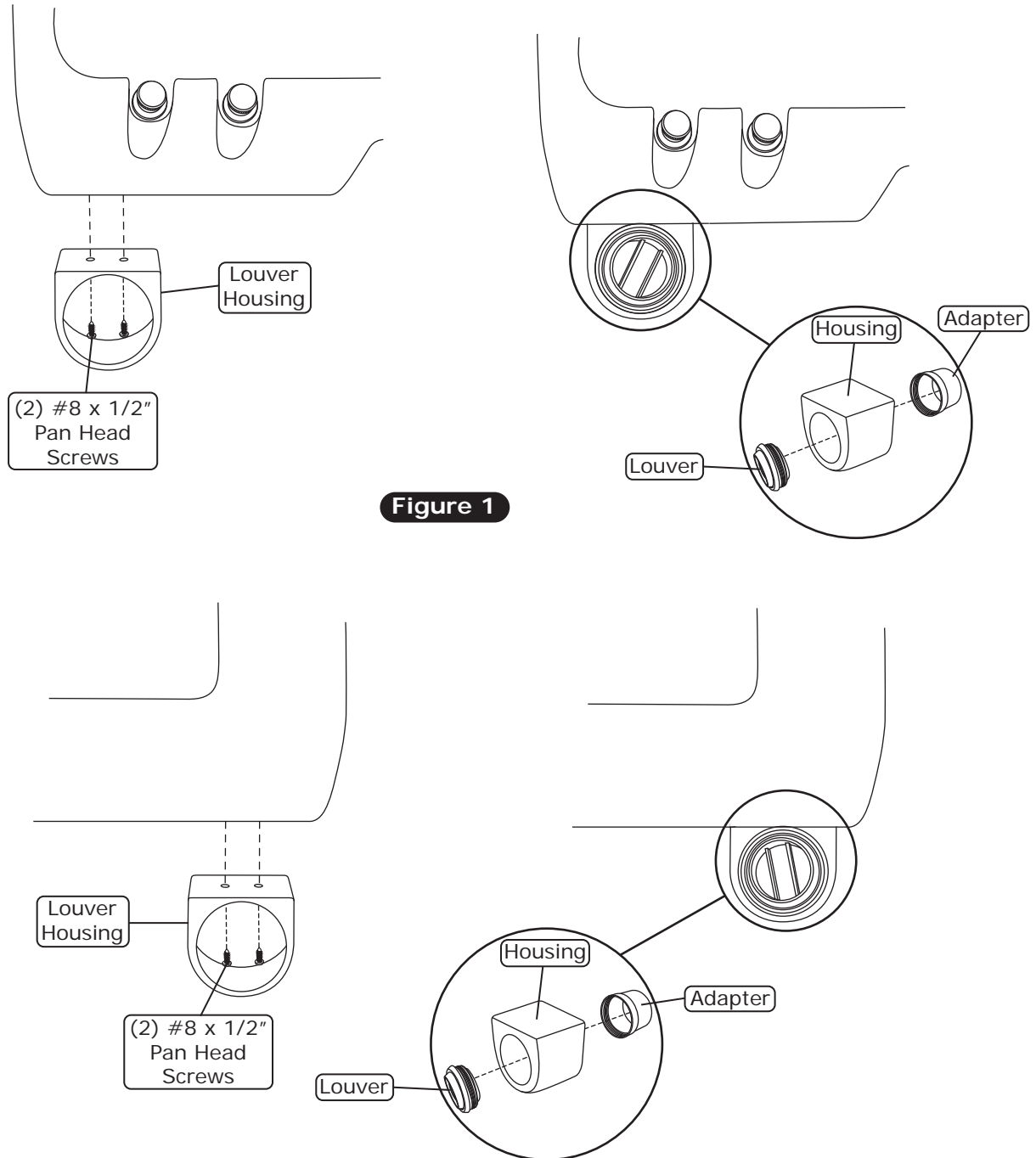

Figure 1



www.vintageair.com

## Control Panel & Duct Hose Routing

**NOTE:** For the system to function optimally, the duct hoses must be routed as directly as possible, taking care to avoid kinks, sharp bends and unnecessary length. Vintage Air supplies duct hoses in continuous lengths that will need to be cut to size depending on application. Before cutting, familiarize yourself with the installation instructions and verify the routing will work with your application. For custom hose routing, additional hose may be needed and can be purchased from Vintage Air.

1. Stretch the duct hose until there is no slack, measure, mark and cut hose to size (See Photo 1, below).

Stretch, measure, mark and cut hose to size



**Photo 1**

**NOTE:** While looking through the glove box and speaker holes, turn the wipers on and check for clearance through the full range of motion.

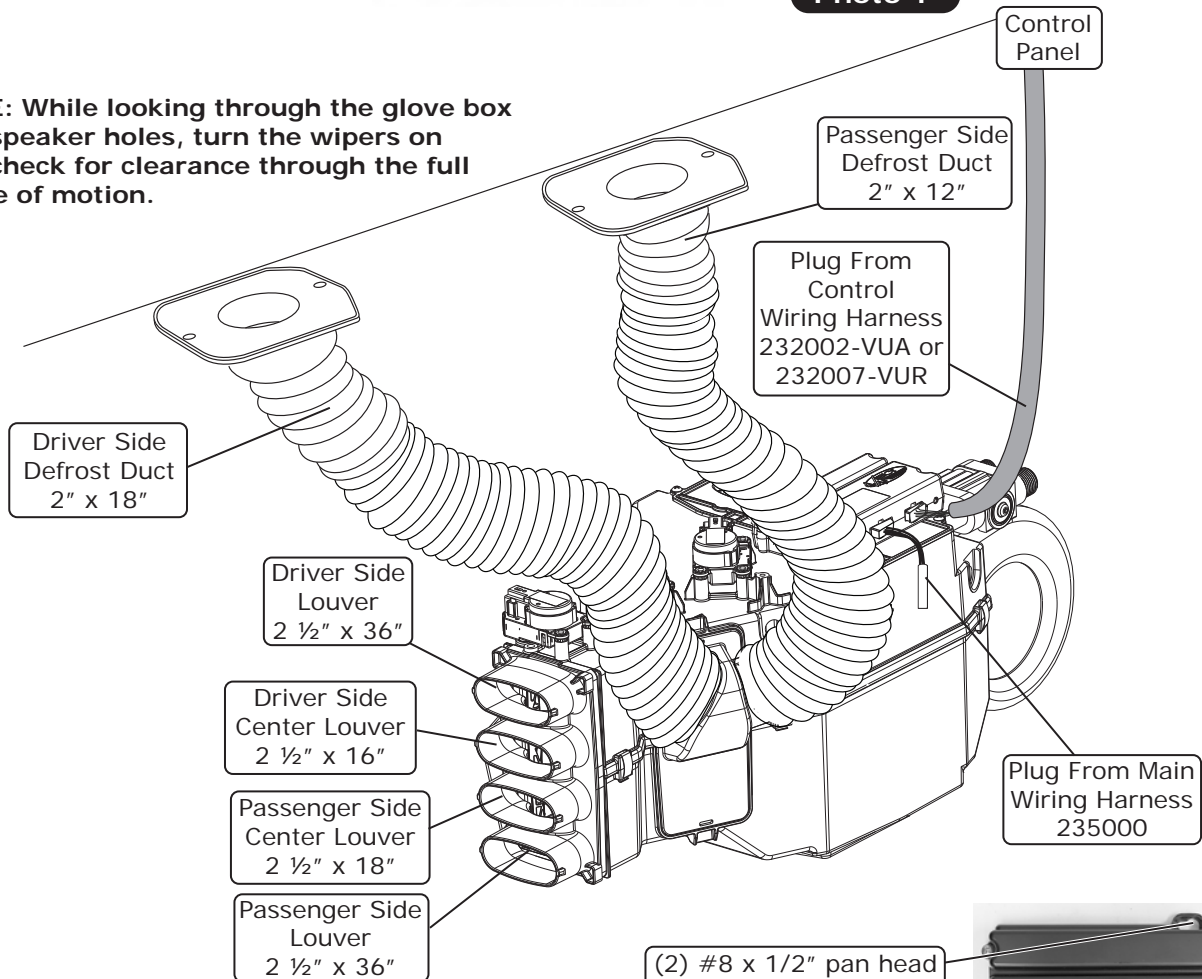

**NOTE:** ECU must be placed away from water and humidity, and also be accessible for servicing. If relocating, connectors must be positioned towards the bottom.



www.vintageair.com

# Final Steps: Installation Check

Installation Check	
ITEM TO CHECK	Procedure
<input type="checkbox"/>	<p>ECU</p> <p>If no blinking is observed after 1 minute of turning the ignition on, go to the next check.</p> <p>If repetitive blinking is observed, go to the <b>Advanced Diagnostics</b> Section to diagnose.</p>
<input type="checkbox"/>	<p>Blower speed control</p> <p>Set the blower speed control to <b>OFF</b>, <u>confirm that the blower is off</u>.</p> <p>Position the blower speed control to <b>LOW</b> then <b>MEDIUM</b> and then <b>HIGH</b>. <u>At each setting confirm that the blower speed increases</u>, do this by feeling for the amount of air coming from the unit and hearing the blower speed increase.</p>
<input type="checkbox"/>	<p>Mode control</p> <p>Set the <b>MODE</b> control to the <b>DASH</b> position. <u>Confirm that air is being blown at the dash vents</u>.</p> <p>Set the <b>MODE</b> control to the <b>FLOOR</b> position. <u>Confirm that air is being blown at the floor vents</u>.</p> <p>Set the <b>MODE</b> control to the <b>DEFROST</b> position. <u>Confirm that all air is being blown from the defrost vents</u></p> <p><b>If heater lines are installed:</b></p> <p>Set the <b>MODE</b> control to the <b>DASH</b> position. Set the <b>TEMP</b> control to the <b>MAX HEAT</b> position. <u>Confirm that HOT air is coming from the dash vents</u>.</p>
<input type="checkbox"/>	<p>Temperature control</p> <p><b>If system is charged:</b></p> <p>Set the <b>TEMP</b> control to the <b>MAX COOL</b> position. <u>Confirm that COLD air is coming from the dash vents</u>.</p> <p>Also <u>confirm that the compressor "clicks" on</u> when adjusting the <b>TEMP</b> control from the <b>MAX HEAT</b> position to the <b>MAX COOL</b> position.</p>
<input type="checkbox"/>	<p>AC Indicator (if applicable)</p> <p>While the <b>MODE</b> control is set to the <b>DASH</b> position, and the <b>TEMP</b> control is set to the <b>MAX COOL/MIN HEAT</b> position, <u>confirm that the blue AC Indicator light is on</u>.</p>
<input type="checkbox"/>	<p>Backlight (if applicable)</p> <p>If your control panel has backlight capabilities and has been wired, turn the dash lamp on and <u>confirm that the AC panel's legend is lit</u>.</p>
<input type="checkbox"/>	<p>Fittings</p> <p>Verify AC and Heater fittings are all tight.</p>



www.vintageair.com

## Final Steps: Completing the Install

1. Install the duct hoses as shown in Figure 1, Page 25.
2. Install the control panel assembly. **NOTE: Controls must be calibrated for proper operation. Refer to control panel instructions.**
3. Install the new glove box using (7) #8 x 3/4" countersunk screws with washers (See Photos 1 and 2, below). **NOTE: Due to the tight clearance between the glove box and ECU, take extra care when installing the glove box this part of the installation may be challenging. Insert this new glove box into the glove box opening as shown in Photo 1, below. Once the glove box is behind the dash rotate the glove box up and slide toward the driver side and into the mounting position.**
4. Reinstall the glove box door using the OEM hardware (See Photo 3, below).
5. Using the template provided on Page 34, modify the center console as shown in Figure 1, below.
6. Reinstall all previously removed items.
7. Fill radiator with at least a 50/50 mixture of approved antifreeze and distilled water. It is the owner's responsibility to keep the freeze protection at the proper level for the climate in which the vehicle is operated. Failure to follow antifreeze recommendations will cause heater core to corrode prematurely and possibly burst in A/C mode and/or freezing weather, voiding your warranty.
8. Double check all fittings, brackets and belts for tightness.
9. Vintage Air recommends that all A/C systems be serviced by a licensed automotive A/C technician.
10. Evacuate the system for a minimum of 45 minutes prior to charging, and perform a leak check prior to servicing.
11. Charge the system to the capacities stated on Page 4 of this instruction manual.
12. See Operation of Controls procedures on Page 31.

Install new glove box using (7) #8 x 3/4" countersunk screws with washers



Photo 1

(7) #8 x 3/4" Countersunk Screws with Washers



Photo 2

Reinstall glove box door using OEM hardware



Photo 3

**NOTE: Use the template for both sides, and then cut across.**

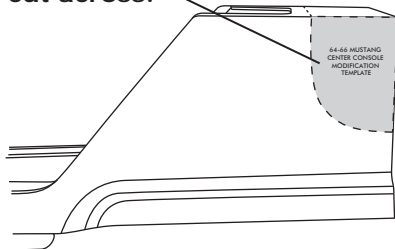
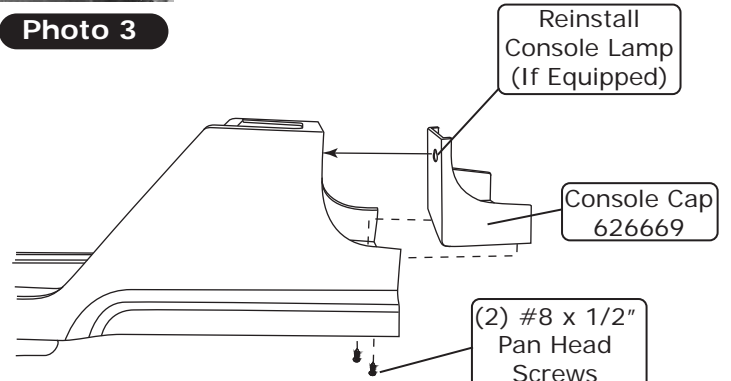

Figure 1

Reinstall Console Lamp (If Equipped)

Console Cap 626669

(2) #8 x 1/2" Pan Head Screws







www.vintageair.com

# Quality Crimp Guideline

Refer to wiring diagram on Page 29, and instructions on Page 30.

Acceptable strip length  
(Some copper visible)

Crimped area is centered  
on each side of splice

Bad strip length  
(Too much copper visible)  
Visible copper should be  
just enough to ensure  
clearance between splice  
area and wire insulation

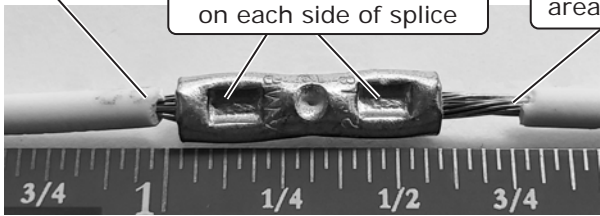

Photo 1

A good crimp requires  
seam of butt splice to be  
opposite of crimp die tooth



Photo 2

## Good Ring Terminal Crimp    Bad Ring Terminal Crimp



Crimped  
area is  
opposite  
of seam

Photo 3

Crimp  
area is  
centered  
on barrel

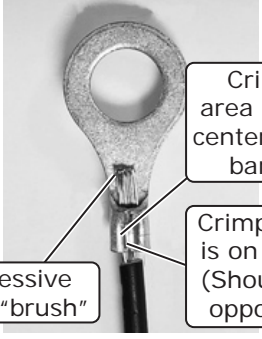

Crimp  
area is not  
centered on  
barrel

Excessive  
wire "brush"

Crimp  
area is  
on seam  
(Should be  
opposite)

Photo 4

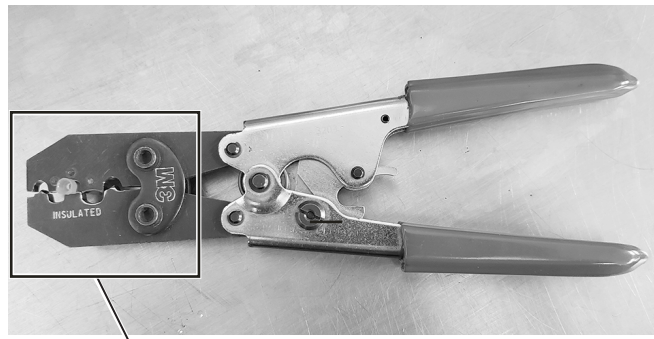

Photo 5

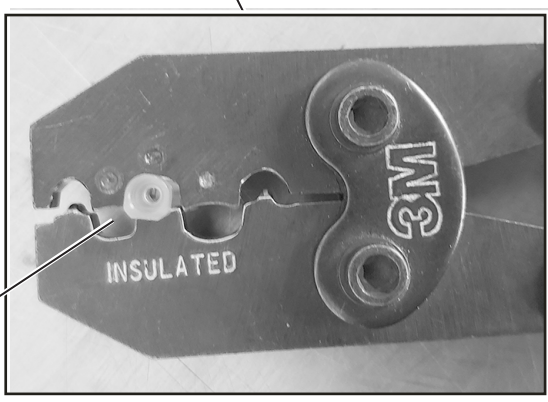

Photo 5a

Use a ratcheting crimp tool  
for insulated barrel terminals  
when crimping the provided  
female insulated terminal.  
Ensure terminal is inserted in  
appropriate position before  
crimping.





www.vintageair.com

# Gen 5 Wiring Diagram

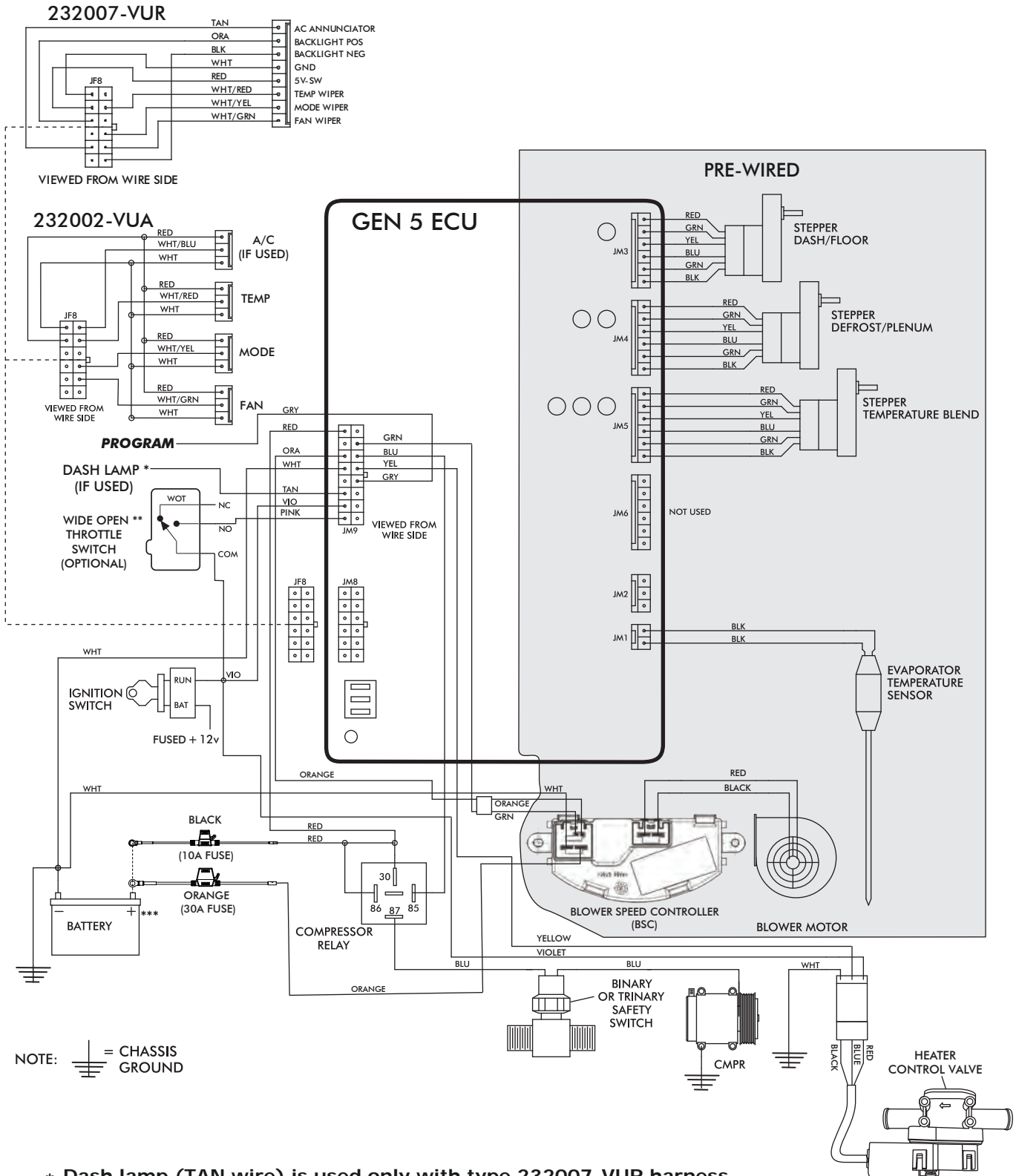

NOTE: = CHASSIS GROUND

- \* Dash lamp (TAN wire) is used only with type 232007-VUR harness.
- \*\* Wide open throttle switch contacts close only at full throttle, which disables A/C compressor.
- \*\*\* Install fuse assemblies at or as near to the battery as possible.



www.vintageair.com

# Gen 5 Wiring Instructions

WIRING HARNESS (231505) ↓

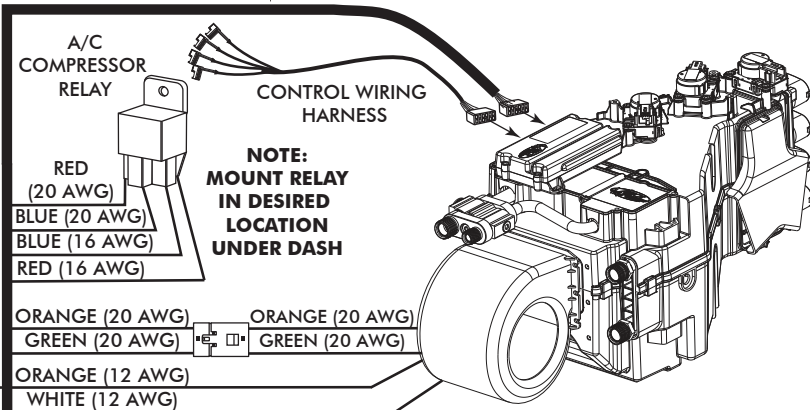

ORANGE (20 AWG) → ORANGE (20 AWG)  
 GREEN (20 AWG) → GREEN (20 AWG)  
 ORANGE (12 AWG)  
 WHITE (12 AWG)

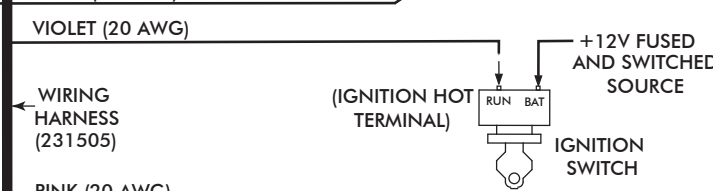

WIRING HARNESS (231505)  
 PINK (20 AWG)  
 TAN (20 AWG) → DASH BACK LIGHT 0 to 12v  
 GRAY (20 AWG) → **GRAY WIRE IS USED FOR PROGRAMING CONTROLS IF APPLICABLE**

FIREWALL

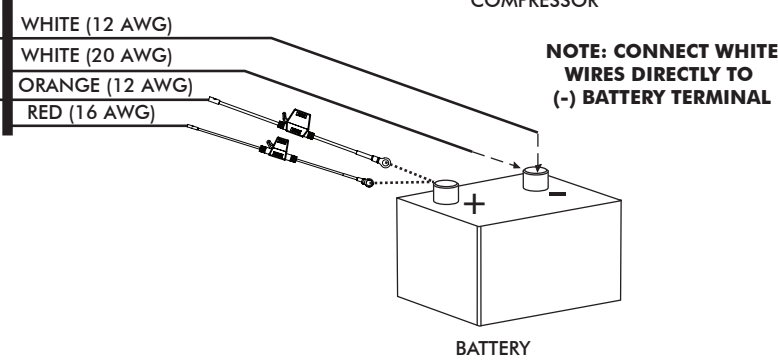
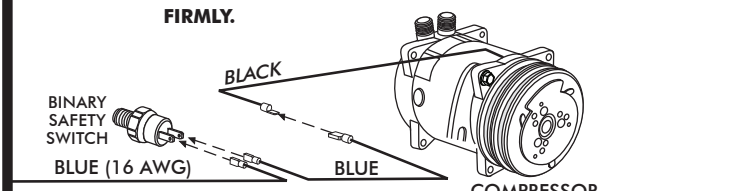
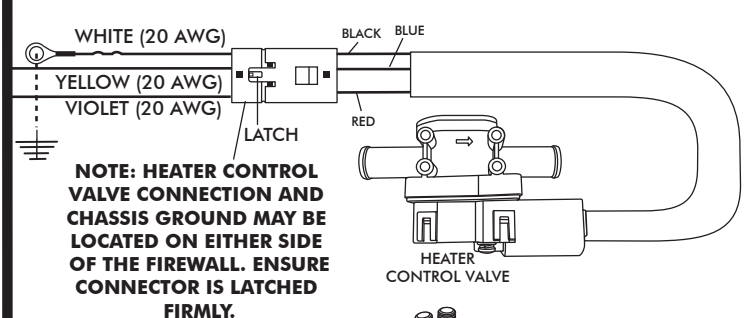

**Ignition Switch:**  
 Using provided butt splice (PN 226004), connect the 20 AWG violet wire to a 5A fused and switched 12V source such as Key On.

**Wide Open Throttle Switch (Optional):**  
 If a wide open throttle switch is required, connect the 20 AWG pink wire to a normally open switch that, when closed, connects a fused and switched 12V source to the pink wire. See Gen 5 wiring diagram for an example.

**Dash Light (Optional):**  
 If using a Vintage Air control panel with back light, connect the 20 AWG tan wire to the vehicle's dash back light 0-12V using provided butt splice (PN 226004).

**Heater Control Valve:**  
 Connect the Violet/Yellow/White twisted branch with 3 position connector into the heater control valve connector. Ensure that the mating latch is fully seated.

**Binary/Trinary & Compressor:**  
**Binary Switch:** Terminate provided insulated female terminal (PN 23172-VUW) to the blue 16 AWG wire. Connect as shown.  
**Trinary Switch:** Connect according to trinary switch wiring diagram.

**Battery Connections:**  
**ECU Ground:** Terminate provided ring terminal (PN 226110) to 20 AWG white wire from the 231505 wire assembly and install at battery.  
**ECU PWR:** Terminate provided fuse assembly with black leads (PN 233012) to the 20 AWG red wire from the 231505 wire assembly. Install provided 10A Red Mini Fuse (PN 226118). Install at battery.  
**Blower Speed Controller (BSC) Ground:** Terminate provided ring terminal (PN 226111) to 12 AWG white wire from the 232020 wire assembly and install at battery.  
**Blower Speed Controller (BSC) PWR:** Terminate provided fuse assembly with orange leads (PN 233008) to the 12 AWG orange wire from the 232020 wire assembly. Install provided 30A Green ATO/ATC Fuse (PN 226125). Install at battery.



www.vintageair.com

## Operation of Controls

On Gen IV or Gen 5 systems with three lever/knob controls, the temperature control toggles between heat and A/C operations. To activate A/C, move the temperature lever/knob all the way to cold and then back it off to the desired vent temperature. For heat operation, move the temperature lever/knob all the way to hot and then adjust to the desired vent temperature. The blower will momentarily change speed, each time you toggle in and out of heat and A/C operations, to indicate the change. **NOTE: For proper control panel function, refer to the control panel instructions for calibration procedure.**

### Blower Speed

This lever/knob controls blower speed, from OFF to HI.

### Mode Control

This lever/knob controls the mode positions, from DASH to FLOOR to DEFROST, with a blend in between.

### Temperature Control

This lever/knob controls the temperature, from HOT to COLD.

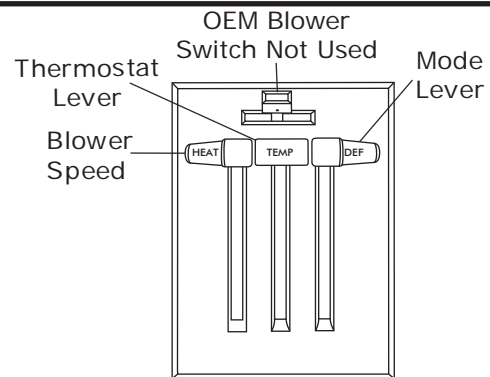

## A/C Operation

### Blower Speed

Adjust to desired speed.

### Mode Control

Adjust to desired mode position (DASH position recommended).

### Temperature Control

For A/C operation, adjust to coldest position to engage compressor (Adjust between HOT and COLD to reach desired temperature).

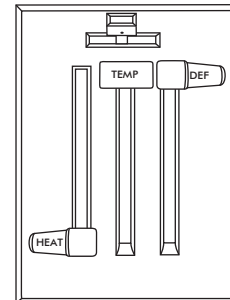

## Heat Operation

### Blower Speed

Adjust to desired speed.

### Mode Control

Adjust to desired mode position (FLOOR position recommended).

### Temperature Control

For maximum heating, adjust to hottest position (Adjust between HOT and COLD to reach desired temperature).

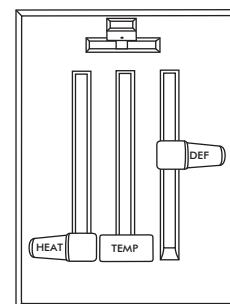

## Defrost/De-fog Operation

### Blower Speed

Adjust to desired speed.

### Temperature Control

Adjust to desired temperature.

### Mode Control

Adjust to DEFROST position for maximum defrost, or between FLOOR and DEFROST positions for a bi-level blend (Compressor is automatically engaged).

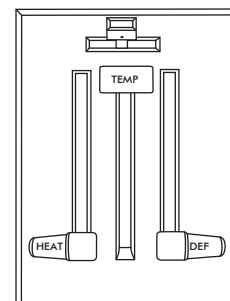



www.vintageair.com

# Troubleshooting Guide

This printed troubleshooting guide is our basic guide that covers common installation problems. To see our advanced diagnostics and troubleshooting guide, please see the following page, for instructions on how to download the complete guide.

**WARNING: While troubleshooting the system, never probe connector terminals from the front mating side, only back probe.**

**WARNING: While troubleshooting the system, never use automotive check lights.**

Symptom	Condition	Checks	Actions	Notes
1. Blower stays on high speed with ignition on.	No other functions work.	Check for damaged pins or wires in the control panel wire assembly and mating header at ECU.	If found damaged, replace wire assembly or ECU.	If fuse continues to blow, there is a serious problem in the wiring. Check all wiring and ensure the wire is not damaged and shorting out along its route.
		Check for a bad ECU GND.		
	All other functions work.	Check for damaged pins or wires in the control panel wire assembly and mating header at ECU.	If found damaged, replace wire assembly or ECU.	
		Check if Blower power fuse is blown.	Replace fuse.	
		Check for a bad ECU GND.	Repair connection.	
2. Compressor will not turn on (All other functions work).	System is not charged.	System must be charged for compressor to engage.	Charge system.	<b>Danger: Never bypass safety switch with engine running. Serious injury can result.</b>
		Check for faulty A/C potentiometer or associated wiring (not applicable to 3-pot controls).	Check continuity to ground on white control head wire. Check for 5V on red control head wire.	To check for proper pot function, check voltage at white/red wire. Voltage should be between 0V and 5V, and will vary with pot lever position.
	System is charged.	Check for disconnected or faulty thermistor.	Check 2-pin connector at ECU housing.	Disconnected or faulty thermistor will cause compressor to be disabled.
		Check for faulty A/C potentiometer or associated wiring.	Repair or replace pot/control wiring.	Red wire at A/C pot should have approximately 5V with ignition on. White wire will have continuity to chassis ground. White/Red wire should vary between 0V and 5V when lever is moved up or down.
	Compressor will not turn off (All other functions work).	Check for faulty A/C relay.	Replace relay.	





www.vintageair.com

# Troubleshooting Guide (Cont.)

Symptom	Condition	Checks	Actions	Notes
4. System will not turn on, or runs intermittently.	Works when engine is not running; shuts off when engine is started	Noise interference from either ignition or alternator.	Install capacitors on ignition coil and alternator. Ensure good ground at all points. Relocate coil and associated wiring away from ECU and ECU wiring. Check for burned or loose plug wires.	Ignition noise (radiated or conducted) will cause the system to shut down due to high voltage spikes. If this is suspected, check with a quality oscilloscope. Spikes greater than 16V will shut down the ECU. Install a radio capacitor at the positive post of the ignition coil (see radio capacitor installation bulletin). A faulty alternator or worn out battery can also result in this condition.
	Will not turn on under any conditions.	Verify connections on power lead, ignition lead, and both white ground wires. Verify battery voltage is greater than 10 volts and less than 16 while engine is running.	Check for power at ECU, and confirm ignition is being applied to ECU properly. Verify proper meter function by checking the condition of a known good battery.	
	Loss of mode door function.	No mode change at all. Check for damaged mode switch or potentiometer and associated wiring.		
	Blower turns on and off rapidly.	Battery voltage is at least 12V. Battery voltage is less than 12V.	Ensure all system grounds and power connections are clean and tight. Charge battery.	
7. Erratic functions of blower, mode, temp, etc.		Check for damaged switch or pot and associated wiring.	Repair or replace.	System shuts off blower at 10V. Poor connections or weak battery can cause shutdown at up to 11V.

## Advanced Diagnostics and Troubleshooting Guide

If after referencing the Troubleshooting Guide, the issue is not resolved, move to The Advanced Diagnostics and Troubleshooting Guide that covers the following:

- ECU Diagnostics Codes
  1. ECU Blink Sequence
  2. Firmware Version Number
  3. ECU Model Number
  4. ECU Start-Up Blink Sequence
  5. Diagnostic Codes
- Complete Advanced Troubleshooting Guidelines

Access the latest version of the Advanced Diagnostics and Troubleshooting Guide by scanning the following QR code on your mobile device:



You can also access the guide by typing the following address into your web browser:

[https://www.vintageair.com/instructions\\_pdf/905000.pdf](https://www.vintageair.com/instructions_pdf/905000.pdf)





www.vintageair.com

## Center Console Modification Template

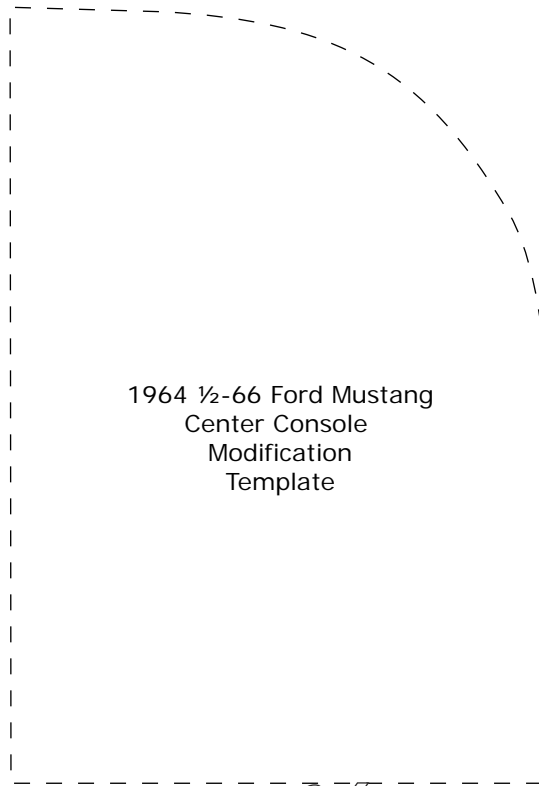

1964 1/2-66 Ford Mustang  
Center Console  
Modification  
Template

Cut Along  
Dotted Line 

**NOTE:** Due to printing variances, measure the line below before using this template. If template is scaled properly, the line should measure 6 inches.











www.vintageair.com

## Packing List: Evaporator Kit (551964)

No.	Qty.	Part No.	Description
1.	1	765200	Gen 5 Super Magnum Evaporator Module
2.	1	781964	Gen 5 Accessory Kit with Conversion Control

Checked By: \_\_\_\_\_  
Packed By: \_\_\_\_\_  
Date: \_\_\_\_\_

1

Gen 5 Super Magnum  
Evaporator Module  
765200

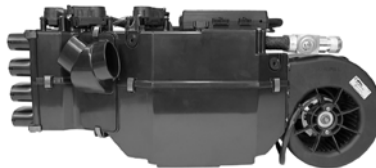

2

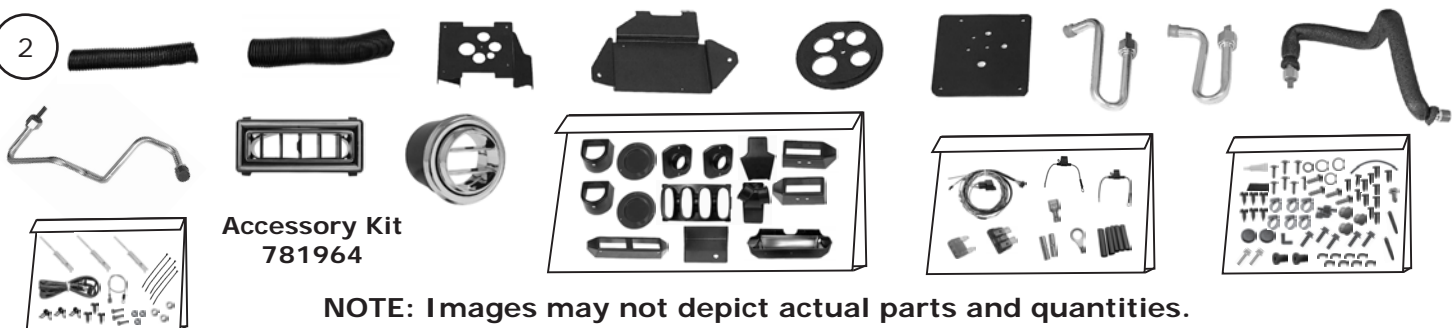

Accessory Kit  
781964

NOTE: Images may not depict actual parts and quantities.  
Refer to packing list for actual parts and quantities.

## Packing List: Evaporator Kit (551965)

No.	Qty.	Part No.	Description
1.	1	765200	Gen 5 Super Magnum Evaporator Module
2.	1	781965	Gen 5 Accessory Kit with Deluxe Control

Checked By: \_\_\_\_\_  
Packed By: \_\_\_\_\_  
Date: \_\_\_\_\_

1

Gen 5 Super Magnum  
Evaporator Module  
765200

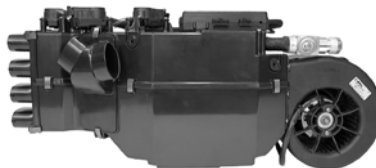

2

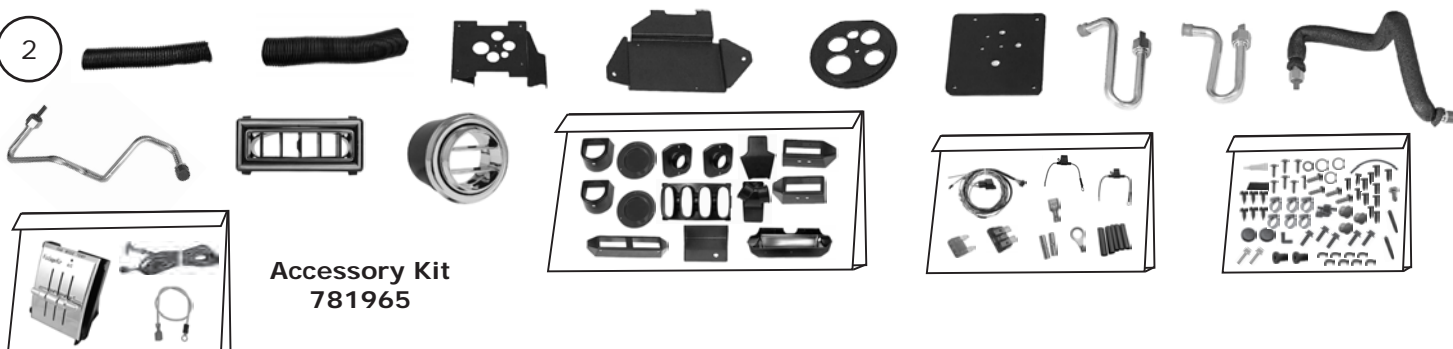

Accessory Kit  
781965

NOTE: Images may not depict actual parts and quantities.  
Refer to packing list for actual parts and quantities.