

**VIEWPOINT RUNNING BOARD
2010-13 CHEVY EQUINOX/GMC TERRAIN
EXCLUDES DENALI MODELS**

PARTS LIST:

Qty	Description	Qty	Description
1	Driver/Left Running Board	6	12-1.75mm x 40mm Bolt Plates (with welded washer)
1	Passenger/Right Running Board	2	12-1.75mm x 40mm Long Bolt Plates
1	Driver/Left Front Inner Mounting Bracket	8	12mm x 32mm OD x 3mm Flat Washers
1	Passenger/Right Front Inner Mounting Bracket	8	12mm Lock Washers
1	Driver/Left Front Outer Mounting Bracket	8	12mm Hex Nuts
1	Passenger/Right Front Outer Mounting Bracket	4	10-1.5mm x 35mm Low Profile Bolt Plate
1	Driver/Left Center Mounting Bracket	12	10-1.5mm x 30mm Hex Bolts
1	Passenger/Right Center Mounting Bracket	4	10mm x 27mm OD x 3mm Large Flat Washers
1	Driver/Right Center Support Bracket	24	10mm x 24mm OD x 2.2mm STD Flat Washers
1	Passenger/Left Center Support Bracket	16	10mm Lock Washers
1	Driver/Left Rear Mounting Bracket	16	10-1.5mm Hex Nuts
1	Passenger/Right Rear Mounting Bracket	12	6-1.0mm x 20mm T-Bolts
1	Driver/Right Rear Support Bracket	12	6mm x 22mm OD x 2mm Flat Washers
1	Passenger/Left Rear Support Bracket	12	6mm Lock Washers
		12	6-1.0mm Hex Nuts

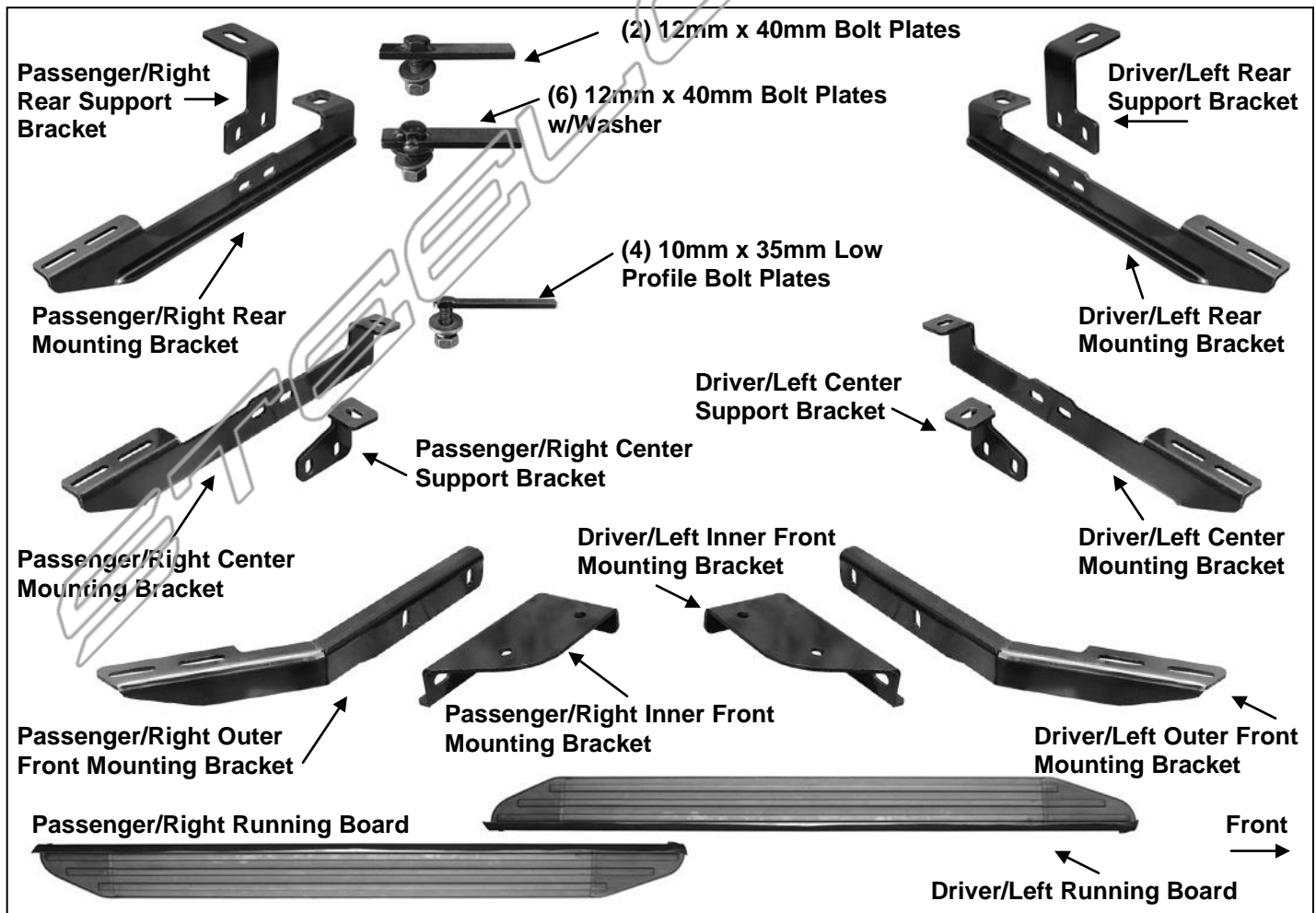

**VIEWPOINT RUNNING BOARD
2010-13 CHEVY EQUINOX/GMC TERRAIN
EXCLUDES DENALI MODELS**

PROCEDURE:

- 1. REMOVE CONTENTS FROM BOX. VERIFY ALL PARTS ARE PRESENT. READ INSTRUCTIONS CAREFULLY BEFORE STARTING INSTALLATION.**
2. Starting at the driver side-front of the vehicle, locate the two large factory holes in the floor panel by the front tires, **(Figure 1)**. Insert (1) 12mm x 40mm Bolt Plate w/Washer into each of the factory holes, **(Figure 2A)**. **IMPORTANT!** Once you have inserted the Bolt Plates, make sure that the welded washer on each Bolt Plate is in the center of the factory hole, **(Figures 2A & 2B)**.
3. Select the driver side front inner Bracket, **(Figure 3)**. Bolt the inner Bracket to the (2) Bolt Plates with the included (2) 12mm Flat Washers, (2) 12mm Lock Washers and (2) 12mm Hex Nuts. Snug but do not tighten hardware at this time. **NOTE: Make sure that the welded-on washers are fully seated in the large openings in the floor at all times before tightening hardware.**
4. Bolt the driver side outer Bracket to the back of the inner Bracket with the included (2) 10mm x 30mm Hex Bolts, (4) 10mm 24mm STD Flat Washers, (2) 10mm Lock Washers and (2) 10mm Hex Nuts, **(Figure 4)**. Leave hardware loose at this time.
5. Move along the floor panel to the center of the vehicle, **(Figure 5)**. Select (2) 10mm x 35mm Low Profile Bolt Plates, **(Figure 6)**. Insert the Bolt Plates into the (2) small holes in the bottom of the floor reinforcement. **NOTE:** The plates on the Bolt Plates should point toward each other, **(Figures 6 & 7)**.
6. Select the driver side Center Support Bracket. Hang the Support Bracket from the outer Bolt Plate with (1) 10mm x 27mm Large Flat Washer, (1) 10mm Lock Washer and (1) 10mm Hex Nut, **(Figure 8)**. Leave loose at this time. Next, repeat to attach the driver side Center Bracket to the inner 10mm Bolt Plate, **(Figure 9)**. Leave hardware loose at this time.
7. Bolt the Center Bracket to the back of the Center Support Bracket with (2) 10mm x 30mm Hex Bolts, (4) 10mm 24mm STD Flat Washers, (2) 10mm Lock Washers and (2) 10mm Hex Nuts, **(Figure 10)**. Leave hardware loose at this time.
8. Continue along the driver side to the rear of the vehicle. Locate the large factory hole in the bottom of the suspension mount, **(Figure 11)**. Insert (1) 12mm x 40mm Bolt Plate w/Washer into the large hole in the suspension mount as described in **Step 2, (Figures 12A & 12B)**. Next, locate the factory hole in the bottom of the inner frame channel. Insert (1) 12mm x 40mm Long Bolt Plate, (no welded washer), into the hole in the bottom of the frame channel, **(Figures 13A & 13B)**.
9. Select the driver side Rear Support Bracket. Hang the Bracket from the outer Bolt Plate w/Washer with (1) 12mm x 32mm Large Flat Washer, (1) 12mm Lock Washer and (1) 12mm Hex Nut, **(Figure 14)**. Leave hardware loose at this time. Repeat to attach the driver side Rear Mounting Bracket to the inner 12mm Bolt Plate in the bottom of the frame channel, **(Figure 15)**. Leave hardware loose at this time.
10. Bolt the Rear Mounting Bracket to the front of the Support Bracket with (2) 10mm x 30mm Hex Bolts, (4) 10mm 24mm STD Flat Washers, (2) 10mm Lock Washers and (2) 10mm Hex Nuts, **(Figure 15)**. Leave hardware loose at this time.
11. Carefully un-wrap the driver side Running Board. Insert (6) 6mm T-Bolts into the slots in the end of the channels, (3 T-Bolts per channel), on the bottom of the Running Board, **(Figure 16)**. Hold the Running Board up in approximate position and slide the T-Bolts down to line up with the (3) Mounting Brackets. Tilt the Board up at a slight angle and push back against the vehicle until the T-Bolts fit into the slots in the Brackets. Loosen Bracket hardware and tilt Brackets downward if necessary. Secure the Running Board to the Brackets with (6) 6mm Flat Washers, (6) 6mm Lock Washers and (6) 6mm Hex Nuts, **(Figure 17)**. Do not tighten hardware.
12. Level and adjust the Sidebar properly and tighten all hardware. **IMPORTANT: Before tightening the front and rear Bracket hardware, make sure that 12mm Bolt Plates are in the center of the large holes in the floor panel.**
13. Repeat **Steps 2 – 12** for passenger side Running Board installation.
14. Do periodic inspections to the installation to make sure that all hardware is secure and tight.

To protect your investment, wax this product after installing. Regular waxing is recommended to add a protective layer over the finish. Do not use any type of polish or wax that may contain abrasives that could damage the finish.

For stainless steel: Aluminum polish may be used to polish small scratches and scuffs on the finish. Mild soap may be used also to clean the Running Board.

**VIEWPOINT RUNNING BOARD
2010-13 CHEVY EQUINOX/GMC TERRAIN
EXCLUDES DENALI MODELS**

Driver Side Installation Pictured

Use these (2) holes

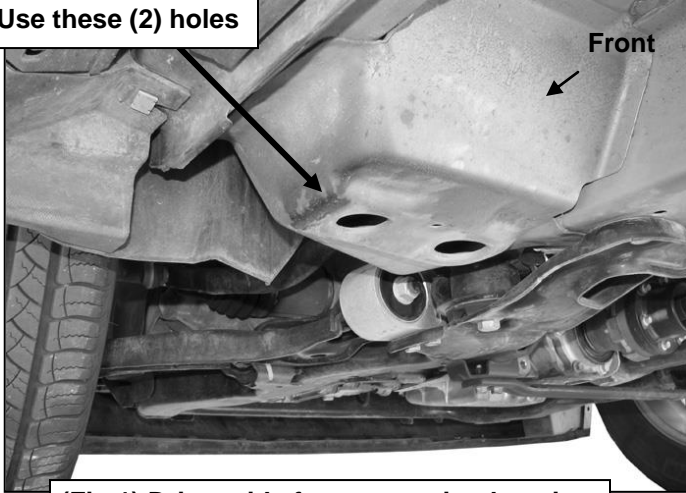

(Fig 1) Driver side front mounting location

(Fig 2A) 12mm Bolt Plate with welded washer

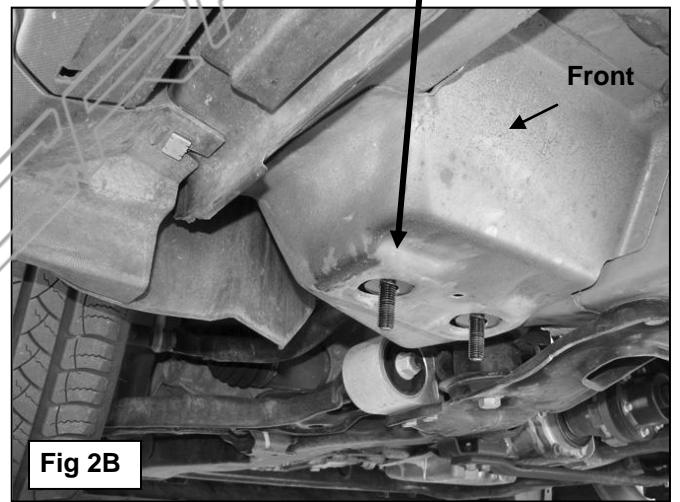

Fig 2B

(2) 12mm Flat Washers
(2) 12mm Lock Washers
(2) 12mm Hex Nuts

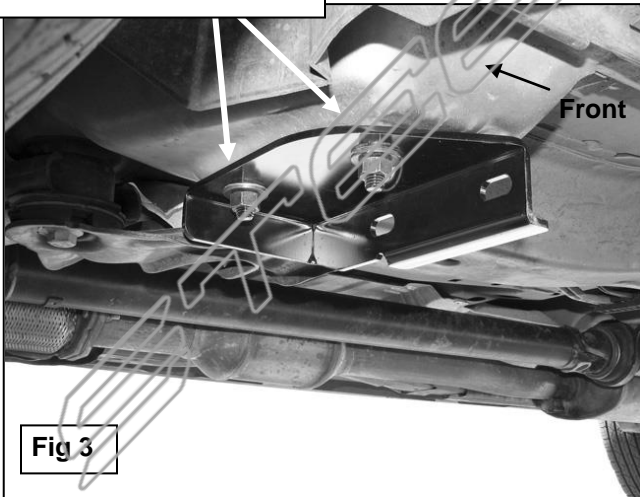
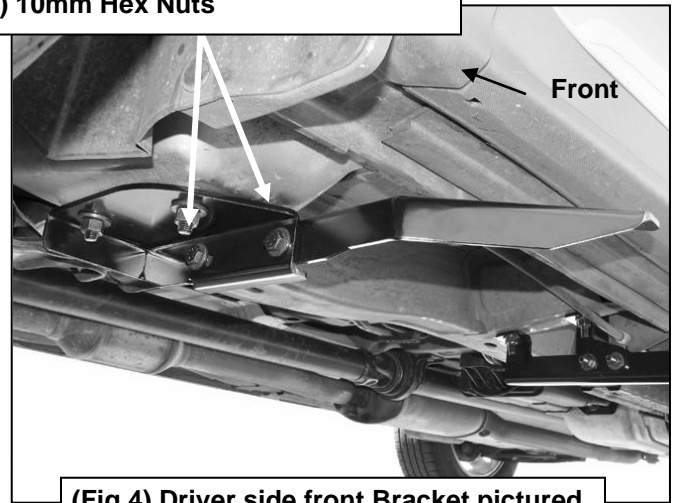

Fig 3

(2) 10mm x 35mm Hex Bolts
(4) 10mm x 24mm STD Flat Washers
(2) 10mm Lock Washers
(2) 10mm Hex Nuts



(Fig 4) Driver side front Bracket pictured

**VIEWPOINT RUNNING BOARD
2010-13 CHEVY EQUINOX/GMC TERRAIN
EXCLUDES DENALI MODELS**

Driver Side Installation Pictured

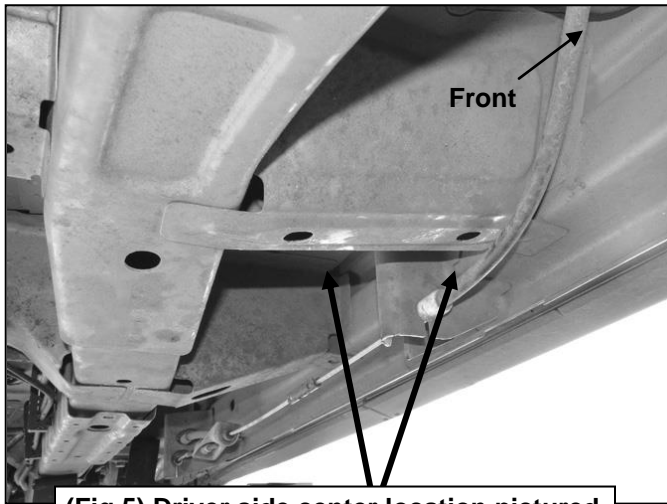

(Fig 5) Driver side center location pictured

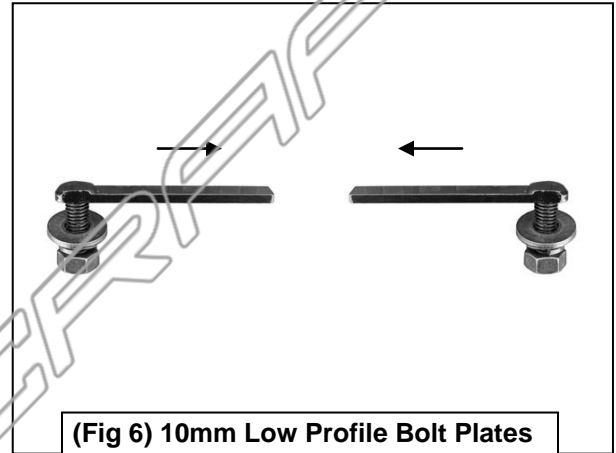

**(Fig 6) 10mm Low Profile Bolt Plates
Install with plates facing each other**

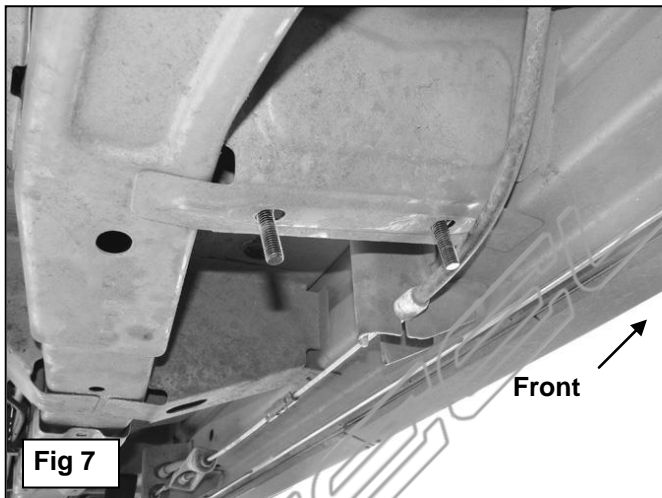

Fig 7

**10mm x 27mm Large
Flat Washer
10mm Lock Washer
10mm Hex Nut**

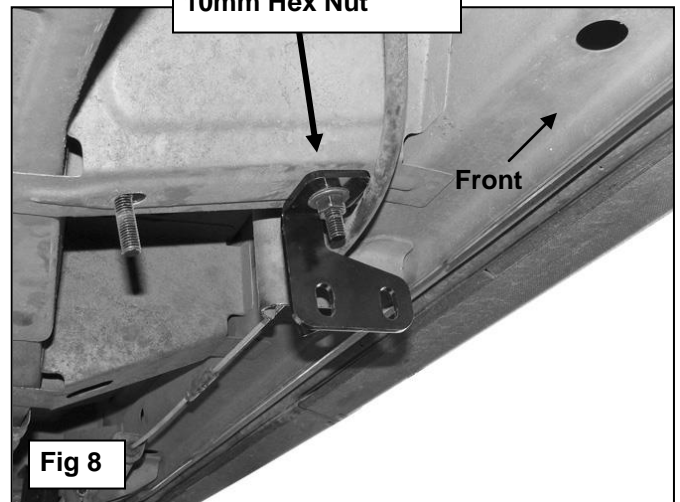

Fig 8

**10mm x 27mm Large Flat Washer
10mm Lock Washer
10mm Hex Nut**

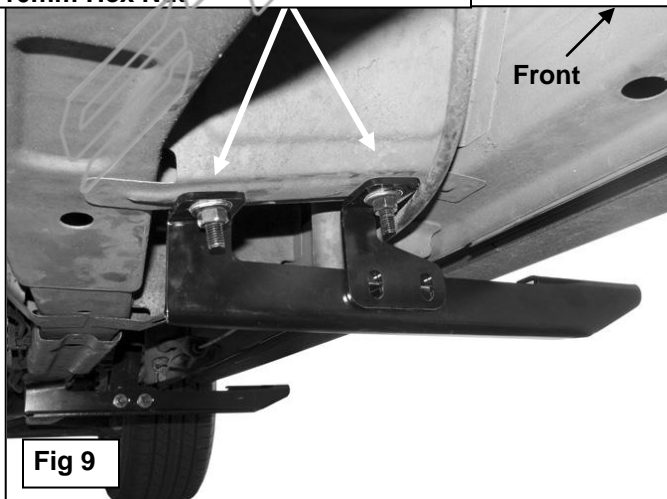
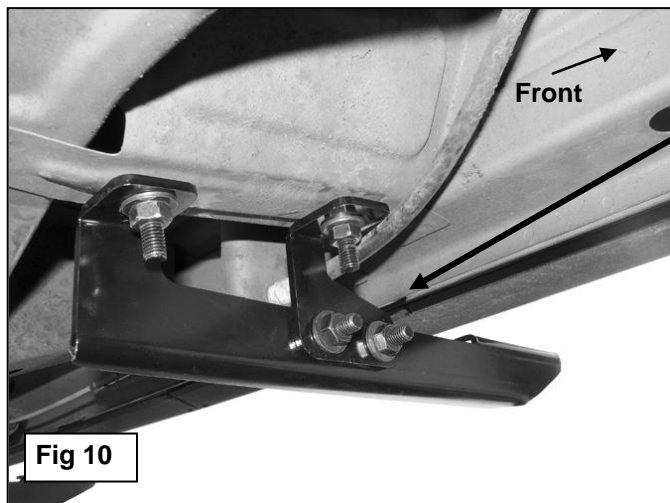
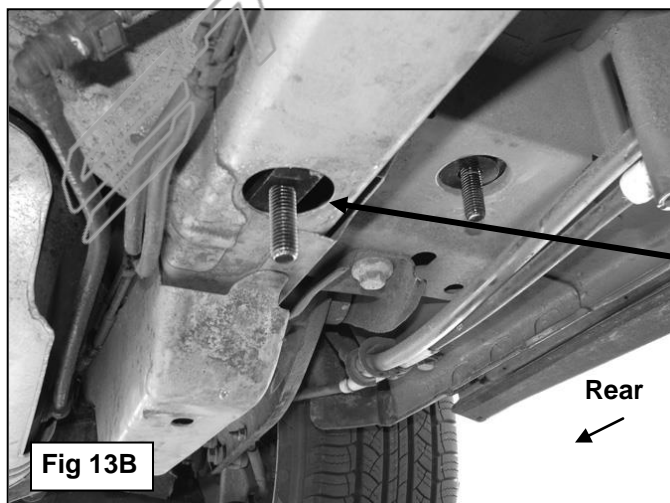
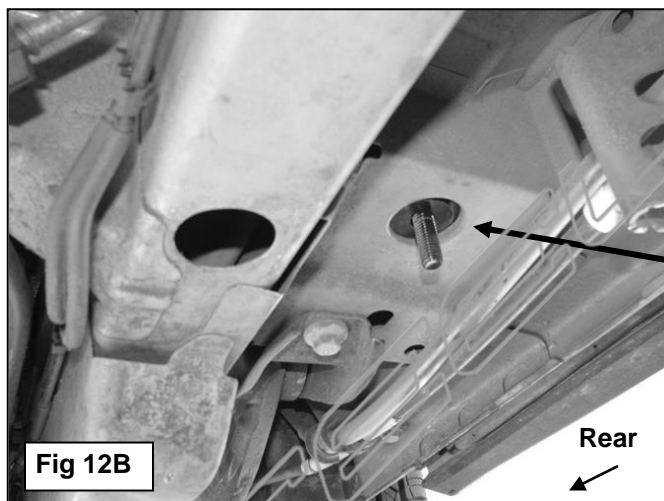

Fig 9

Driver Side Installation Pictured



- (2) 10mm x 35mm Hex Bolts
- (4) 10mm x 24mm STD Flat Washers
- (2) 10mm Lock Washers
- (2) 10mm Hex Nuts



**VIEWPOINT RUNNING BOARD
2010-13 CHEVY EQUINOX/GMC TERRAIN
EXCLUDES DENALI MODELS**

Driver Side Installation Pictured

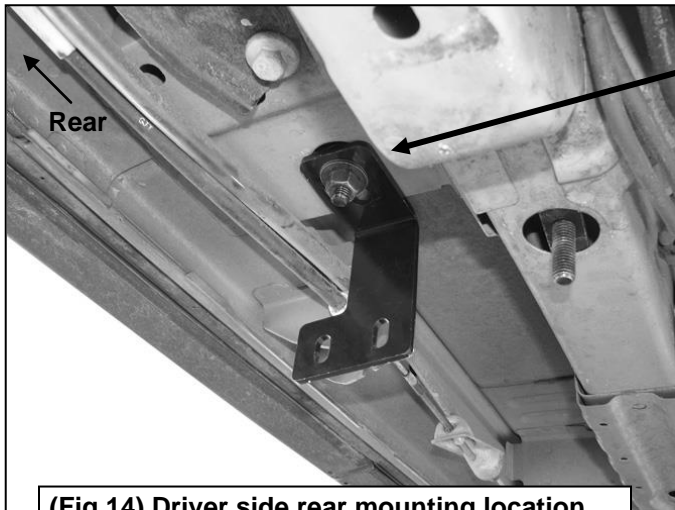

12mm Flat Washers
12mm Lock Washers
12mm Hex Nuts

(Fig 14) Driver side rear mounting location

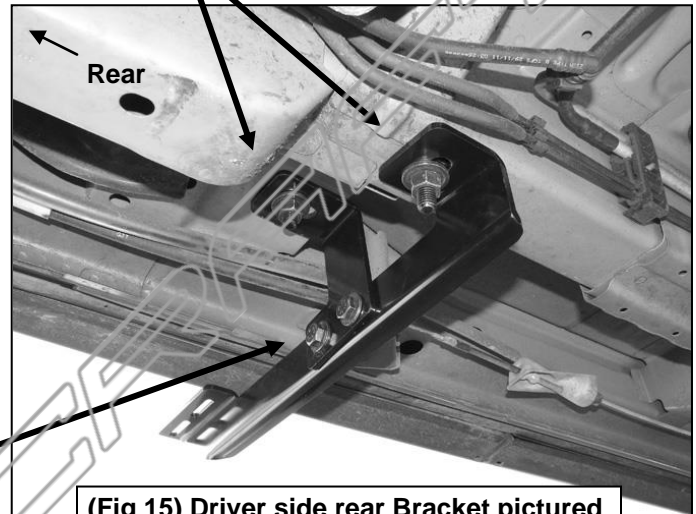

(Fig 15) Driver side rear Bracket pictured

(2) 10mm x 35mm Hex Bolts
(4) 10mm x 24mm STD Flat Washers
(2) 10mm Lock Washers
(2) 10mm Hex Nuts

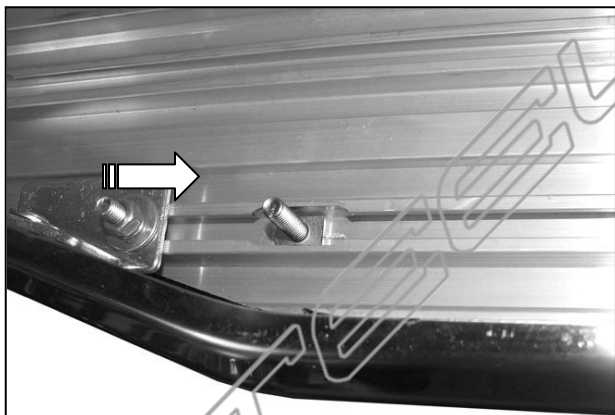

(Fig 16) Slide (3) T-Bolts into each channel

(2) 6mm Flat Washers
(2) 6mm Lock Washers
(2) 6mm Hex Nuts

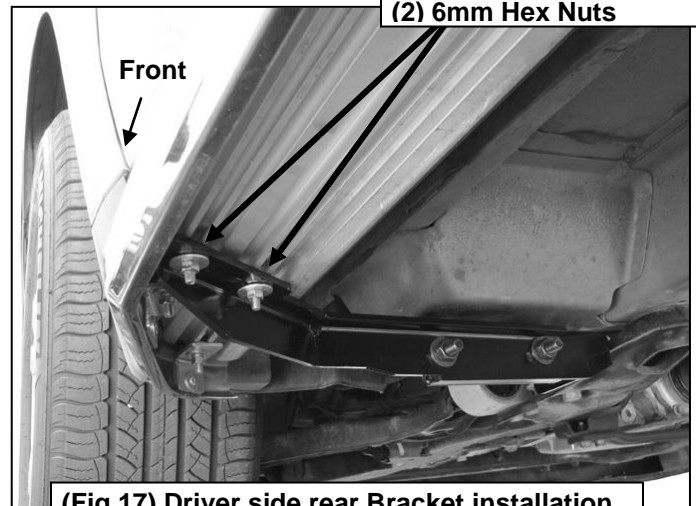

(Fig 17) Driver side rear Bracket installation



Installation Complete