

PARTS LIST:

1	Driver/Left Taillight Guard
1	Passenger/Right Taillight Guard

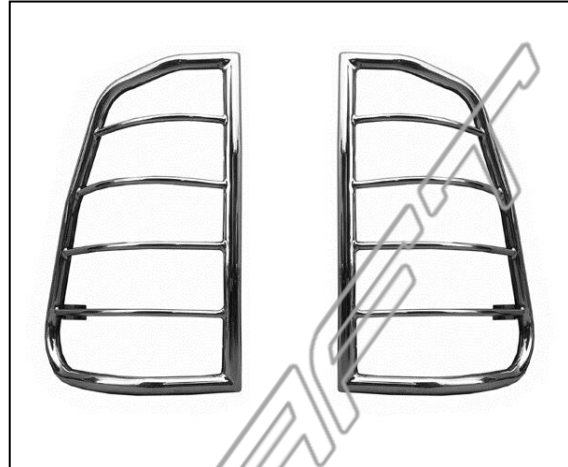

PROCEDURE:

- 1. REMOVE CONTENTS FROM BOX. VERIFY ALL PARTS ARE PRESENT. READ INSTRUCTIONS CAREFULLY BEFORE STARTING INSTALLATION. ASSISTANCE IS RECOMMENDED.**
- Open the tailgate and remove the (2) factory hex bolts holding the driver side taillight assembly into the inner body panel, **(Figure 1)**.
- Firmly grasp the bottom and top of the plastic taillight assembly with both hands and pull directly back and away from the vehicle to release the pins on the assembly from the push-in sockets, **(Figure 2)**.
NOTE: Complete taillight assembly removal is not required for installation. This is the same procedure required to replace a taillight bulb.
- Select the driver/left side Taillight Guard. Slide the Guard down from the top of the taillight assembly, **(Figure 3)**. Hook the small mounting tab onto the left/outer edge of the assembly, **(Figures 4A & 4B)**. Match up the (2) mounting brackets on the right side with the (2) mounting holes, **(Figure 5)**. **NOTE:** There will be a gap between the taillight assembly and the mounting tabs. Do not adjust or bend any of the brackets, (only bend the tabs if necessary after initial test fit), until after the taillight guard has been completely installed.
- Use both hands, (one at the top, one at the bottom), to hold the Guard loosely over the taillight assembly. Slide the guard and taillight forward into the opening in the fender with the taillight assembly on the inside of the fender housing and the long tabs on the outside of the inner bed side, **(Figure 5)**. Keep the small tab hooked on the outer edge of the taillight assembly.
- Line up the factory mounting pins on the taillight with the sockets in the end of the bed side.
IMPORTANT: Do not push the taillight assembly in all the way, (until it "pops" into place), at this time. Check the fit of the mounting tabs against the side of the bed and the assembly before proceeding, **(Figure 6)**. The mounting tabs on the Taillight Guard can be adjusted for alignment as required. Do not bend/adjust the tabs until after first trial fit. Carefully re-bend the tabs with pliers as necessary for proper fit. Cover the tabs with removable tape to prevent scratches to the finish.
- Once the Guard is properly lined up with the (2) inner mounting holes, push the taillight assembly back into the original position until you hear the push pins "pop." **VERY IMPORTANT:** To avoid damage to the vehicle's finish, **do not slide the Taillight Guard up or down once taillight assembly has been "popped" into place** and fully installed. Make all adjustments before pushing the taillight assembly all of the way into position.
- Use the (2) factory hex bolts to attach the mounting tabs to the side of the tailgate opening, **(Figure 7)**.
- Once the Taillight Guard is fully installed, slowly close the tailgate and check for clearance.
IMPORTANT: Do not close the tailgate without checking for clearance first.
- Repeat **Steps 2 - 9** for passenger side Taillight Guard installation.
- Do periodic inspections to the installation to make sure that all hardware is secure and tight.

TAILLIGHT GUARD 2005-13 TOYOTA TACOMA

To protect your investment, wax this product after installing. Regular waxing is recommended to add a protective layer over the finish. Do not use any type of polish or wax that may contain abrasives that could damage the finish.

For stainless steel: Aluminum polish may be used to polish small scratches and scuffs on the finish. Mild soap may be used also to clean the Taillight Guard.

For gloss black finishes: Mild soap may be used to clean the Taillight Guard.

Driver Side Installation Pictured

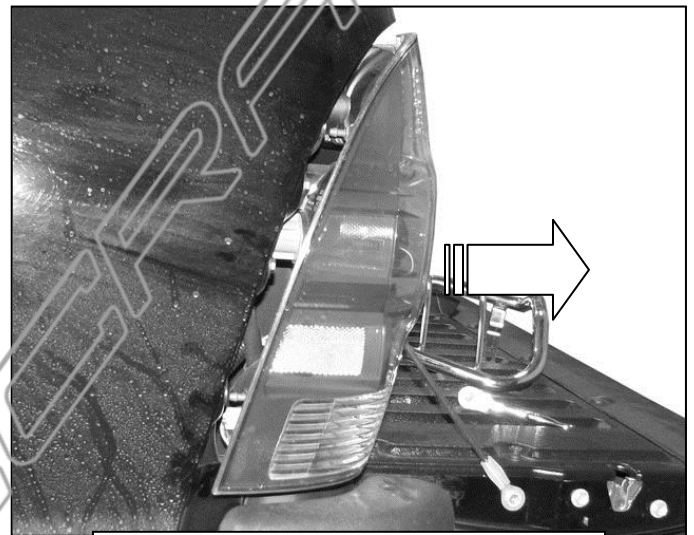
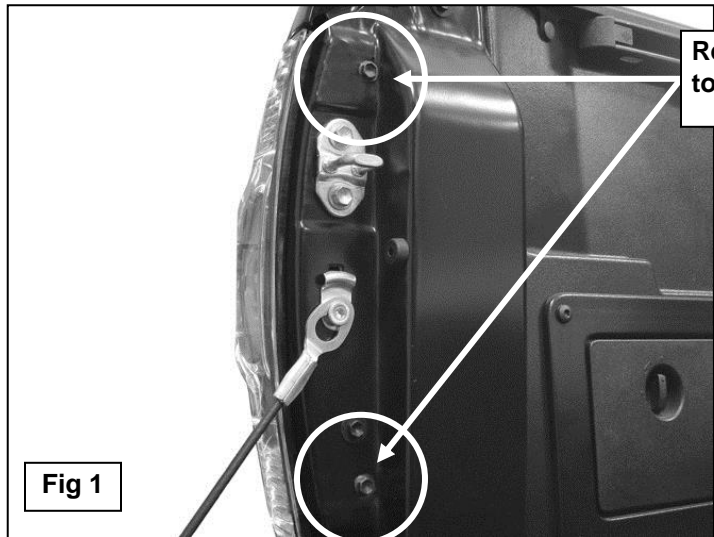

(Fig 2) Firmly grasp taillight assembly at top and bottom and pull straight out from vehicle (toward rear)



(Fig 3) Slide the Taillight Guard over the taillight assembly from the top down

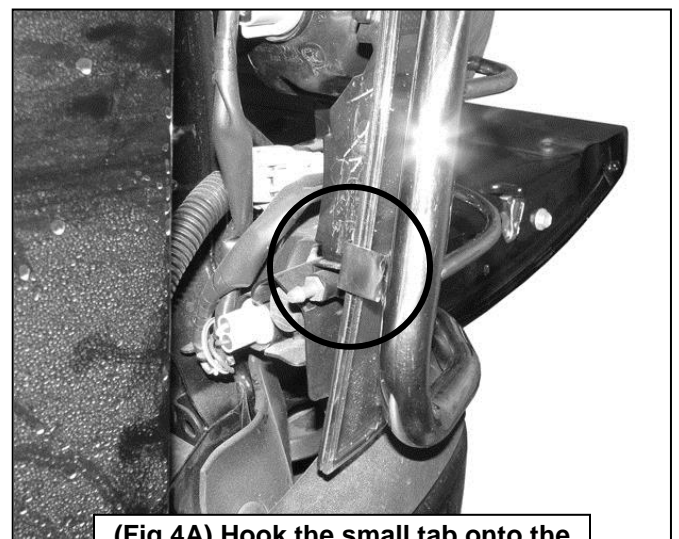

(Fig 4A) Hook the small tab onto the outer edge of the taillight assembly

Driver Side Installation Pictured

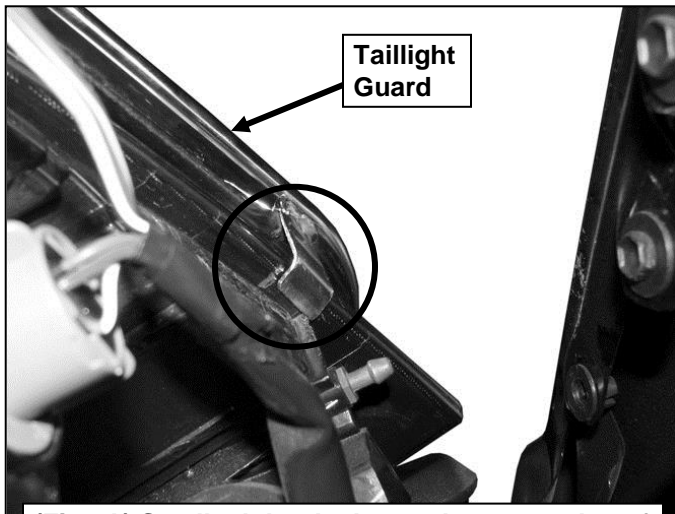

(Fig 4A) Small tab hooked onto the outer edge of the taillight assembly (back of taillight assembly pictured from above)



(Fig 5) Use both hands (one on bottom, one on top) to hold the Taillight Guard in place over the taillight. Slide the taillight and Guard into the opening in the rear fender

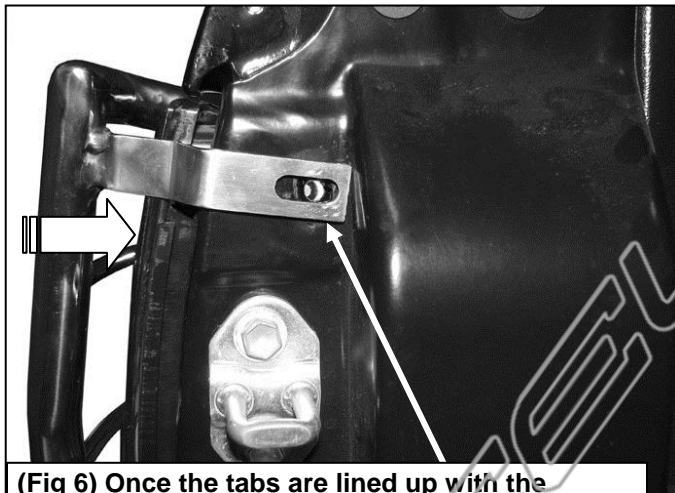

(Fig 6) Once the tabs are lined up with the mounting holes, push only the taillight assembly into place until the mounting pins "pop." DO NOT PUSH the taillight assembly all of the way in until the tabs on the Taillight Guard are lined up with the mounting holes

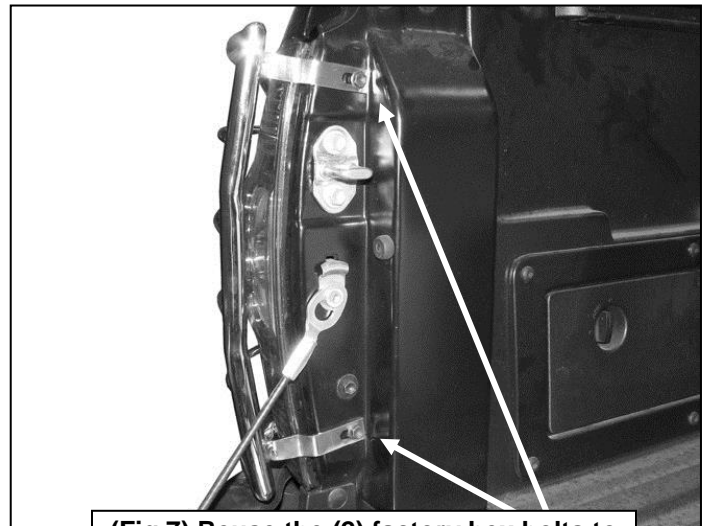

(Fig 7) Reuse the (2) factory hex bolts to attach the Taillight Guard to the vehicle