

HOOKER[®] HEADERS

TABLE of CONTENTS

SUPER COMP & COMP HEADERS

- Street Force[®] Emission Compatible - (pg. 4)
- **NEW** LS1 Camaro/Firebird Headers & Y-pipe - (pg. 5)
- Comp Headers - (pgs. 6-10)
- **NEW** 2005-07 Mustang Exhaust - (pg. 11)
- Super Comp Full length - passenger car - (pgs. 12-18)
- Super Comp Truck Full Length - 2WD - (pgs. 19-21)
- Super Comp Truck Full Length - 4WD - (pgs. 21,22)
- Super Comp Engine swap - (pgs. 23-26)
- Super Comp Block hugger - (pg. 29)
- Super Comp Sidemount - (pg. 30)
- Super Comp Roadster - (pg. 31)
- Super Comp Race - adjustable - (pgs. 32,34)
- Super Comp Race - weld-up - (pg. 35)
- Super Comp Race - circle track - (pg. 36)
- Super Comp Race - tractor pull - (pg. 36)

EXHAUST SYSTEMS

- Super Competition Dual Systems (pg. 37)
- Competition Exhaust Systems (pgs. 37,38)
- Truck Force[®] Diesel Truck Systems - (pg. 39)
- Super Competition Late Model Mustang Catback Systems (pg. 40)
- Street Force[®] Cat-backs - (pg. 41)

MUFFLERS

- Aero Chamber - (pgs. 42-44)
- Maximum Flow - (pgs. 45,46)
- Turbo - (pg. 47)
- Tuned Flow - (pg. 48)
- Universal Elite & Turnout - (pg. 49)
- Sidemounts - (pgs. 50)

EXHAUST TIPS

- Large bore - (pg. 51)
- European style - (pg. 52)
- Elite Tip - (pg. 52)

EXHAUST SYSTEM COMPONENTS

- Engine swap mounts - (pgs. 27,28)
- Flange kits - (pgs. 53,54)
- Tubing - (pgs. 55,56)
- Miscellaneous Components - (pg. 57)
- Header collectors & extensions - (pgs. 58-60)
- Alt/AC/PS adaptor brackets - (pg. 60)
- Reducers & Cut-a-ways - (pgs. 61)
- Flange gaskets - (pgs. 62,63)
- Collector seals - (pg. 63)
- Car Bars - (pg. 64)

Frequently asked header questions (pg. 65)

Product Gallery (pg. 69-76)

Part Number-To-Page Index (pg. 77-79)

INTRODUCTION

EMISSION CODES & COMPANY INFORMATION

EMISSION CODES

Hooker and other manufacturers have developed a program whereby all emission-sensitive products can be identified by placing color-coded & numbered labels on product packaging and listing corresponding numeric codes next to each part number. The color coded corresponding numbers and explanations are as follows:

GREEN



The product accompanying this document has been granted a California Air Resources Board (CARB) exemption, an "EO" number, or is a direct or consolidated replacement part. It is 50-state legal, per the manufacturer's application guide.

BLUE



The manufacturer of the product accompanying this document represents that it has not been found, nor is believed to be, unlawful for use under provisions of the Clean Air Act, per the manufacturer's application guide. This product is not legal for sale or use in the State of California (or in states which have adopted California emission standards) except on pre-emission-controlled motor vehicles/motor vehicle engines (pre-1974 model year).

AMBER



The product accompanying this document is legal only for off-highway use (except in California or states that have adopted California emission standards), racing use or for use on pre-emission-controlled motor vehicles/motor vehicle engines (pre-1974 domestic vehicles certified to California standards, pre-1974 domestic vehicles certified to federal standards and all pre-1974 foreign vehicles), per the manufacturer's application guide.



THE WORLD'S BEST HEADER!

It's a tall statement, but true. The fact of the matter is that Hooker has been in the business of making the best headers since the 1960s. From the hey day of the factory Super Stock teams such as Sox and Martin, Bob Glidden, Arnie Beswick, Dave Strickler, Arlen Vanke, Grumpy Jenkins, and a host of other names that literally were household names back then, Hooker was there.

Hooker honed its teeth on the first of the factory big block muscle cars, making premium quality headers for the street, strip and oval track. From this auspicious beginning, Hooker branched its product line out to include headers and exhaust systems to include many "non-race" applications such as RVs, tow vehicles, off-road vehicles and many daily-drivers.

Today, four decades later, Hooker is still there, bigger and stronger than ever, and a member of the Holley family of fine performance products. Noted racers such as Greg Anderson, Jason Line, Dan Fletcher, Kevin Helms and Anthony Bertozzi have taken up the Hooker banner and continue to add significant racing victories and laurels to the Hooker mystique. Hooker isn't referred to as "the winningest header in history" for nothing!

Factor in the state-of-the-art engineering and R&D facility, in Bowling Green, KY, and it's readily apparent that Hooker has solidified its position as the "World's Best Header!" manufacturer. The year will continue to see an ever-increasing commitment by Hooker to offer an extensive and high quality exhaust product line.

You, our customer, will be the ultimate benefactor of the Hooker commitment. Just as your past support for Hooker products was earned by their features, quality and performance, so will your current and future support of Hooker products be based. To this end, Hooker will continue to offer THE BEST exhaust performance products in the business,

Period.



A Holley Performance Brand



Tech Line: **270-781-9741**

3

STREET FORCE® & LS1 HEADERS & Y-PIPE

FORD, GM, DODGE, JEEP, TOYOTA & NEW LS1 HEADERS & Y-PIPE

STREET FORCE® CAR HEADERS

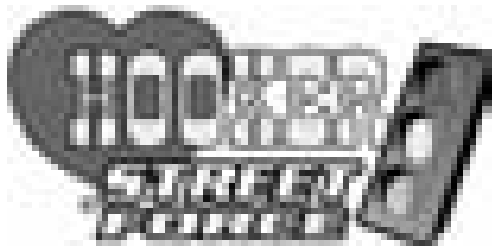

Hooker Street Force Headers are designed to be a high performance alternative to the stock O.E. manifolds. These headers are built to accommodate all emission control devices. Please check your application in this section for more information regarding emissions legality.

YEARS	ENGINES	Baked-On Black PAINT	Metallic Ceramic COATING	EMISSION CODE	FOOTNOTES	P/S	P/B	A/C	TRANSMISSION STANDARD/ AUTO		TUBE SIZE O.D. IN	COLL SIZE O.D. IN	COLL LN IN	PORT SHAPE		
									COL	FL					COL	FL
FORD																
MUSTANG																
86-93	255-302W	6128HKR	6128-1HKR	◆ 4,25,49,90,169,275		Y	Y	Y	N	Y	N	Y	15/8	3	3	SAP
86-93	255-302W	6129HKR	6129-1HKR	◆ 4,49,64,90,169,275		Y	Y	Y	N	Y	N	Y	15/8	3	3	SAP
86-93	255-302W	6132HKR	6132-1HKR	◆ 4,35,49,169,275		Y	Y	Y	N	Y	N	Y	15/8	3	3	SAP
94-95	255-302W	6131HKR	6131-1HKR	◆ 4,35,49,71,90,169,275		Y	Y	Y	N	Y	N	Y	15/8	3	3	SAP
94-95	351W	6133HKR	6133-1HKR	◆ 4,57,68,90,275		Y	Y	Y	N	Y	N	Y	15/8	3	3	SAP
NEW 05-06	4.6L 3V	6138HKR	6138-1HKR	◆ 4,57,90,279		Y	Y	Y	N	Y	N	Y	15/8	2 1/2	3	SAP
NEW 05-06	4.6L 3V	16684HKR*		5	Cross-pipe without extension tubes for 6138HKR/6138-1HKR - for vehicles w/ catalytic converters											
NEW 05-06	4.6L 3V	16784HKR*		5	Cross-pipe with extension tubes for 6138HKR/6138-1HKR - for vehicles w/o catalytic converters											
* Ford cross pipes come in raw stainless steel																
GENERAL MOTORS																
CAMARO / FIREBIRD																
86-90	305-350	2055HKR	2055-1HKR	◆ 62,173,215		Y	Y	Y	N	Y	N	Y	15/8	3	3	SAP
93	350 LT-1	2060HKR	2060-1HKR	◆ 62,171,215		Y	Y	Y	N	Y	N	Y	15/8	2 1/2	5	SAP
94-95	350 LT-1	2062HKR	2062-1HKR	◆ 62,90,171,215		Y	Y	Y	N	Y	N	Y	15/8	2 1/2	5	SAP
95-97	350 LT-1	2064HKR	2064-1HKR	◆ 62,90,215		Y	Y	Y	N	Y	N	Y	15/8	2 1/2	5	SAP
98	350 LS-1	2077HKR	2077-1HKR	◆ 215		Y	Y	Y	N	Y	N	Y	15/8	2 1/4	3	RD
CORVETTE																
92-95	350 LT-1	2061HKR	2061-1HKR	◆ 62,170,215		Y	Y	Y	N	Y	N	Y	1 3/4	3	1 1/2	REC
97-98	350 LS-1	2076HKR	2076-1HKR	◆ 215		Y	Y	Y	N	Y	N	Y	15/8	3		SAP
CHEVELLE, MALIBU, MONTE CARLO, EL CAMINO, CABALLERO, SPRINT, WAGONS																
83-88	305 LG-4	2049HKR	2049-1HKR	◆ 62,90,179,215		Y	Y	Y	N	Y	Y	Y	15/8	2 1/2	5	SAP
83-88	305 L-69	2050HKR	*2050-1HKR	◆ 62,111,179,215		Y	Y	Y	N	Y	Y	Y	15/8	3	3	SAP
IMPALA SS																
94-96	350 LT-1	2063HKR	2063-1HKR	◆ 62,215		Y	Y	Y	N	N	Y	Y	1 3/4	3	3	REC



NEW!

CAMARO/FIREBIRD LS1 HEADERS & Y-PIPE



HOOKER'S POWER SPEAR™

collector manages exhaust pulses, broadens torque curve and maintains high exhaust gas velocity.

- Big 1-7/8" (Super Competition) or 1-3/4" (Competition) tuned length primary tubes
 - Super Competition version features a 3" slip-fit Power Spear™ collector for efficient high RPM scavenging and reduced backpressure
 - Competition version features a 3" slip-fit long transition 9" conventional collector for efficient scavenging and reduced backpressure.
 - Made of sturdy 18 (Super Competition) or 16 (Competition) gauge tube
 - Precision machined 3/8" head flange for perfect sealing
 - Tight tuck collector designs make it easier to lower vehicle
- Industry's best welds for appearance and long life
- Offered in high temp black paint, metallic ceramic coated or 304 stainless steel
- Easy to install and come complete with hardware and instructions
- Y-pipe bolts right in and includes a bracket that slips into the factory hanger. This Y-pipe will fit all Hooker Super Competition and Competition headers

Part #	Camaro/Firebird (Super Competition)
2290HKR	1998-99 1-7/8", painted
2290-1HKR	1998-99 1-7/8", coated
2290-2HKR	1998-99 1-7/8", stainless
2291HKR	2000-02 1-7/8", painted
2291-1HKR	2000-02 1-7/8", coated
2291-2HKR	2000-02 1-7/8", stainless

Part #	Camaro/Firebird (Competition)
2468HKR	1998-99 1-3/4", painted
2468-1HKR	1998-99 1-3/4", coated
2468-2HKR	1998-99 1-3/4", stainless
2469HKR	2000-02 1-3/4", painted
2469-1HKR	2000-02 1-3/4", coated
2469-2HKR	2000-02 1-3/4", stainless
16723HKR	1998-02 Y-pipe mild steel for 2290/2291/2468/2469/2253/2254
16723-2HKR	1998-02 Y-pipe 409 stainless steel for 2290/2291/2468/2469/2253/2254

Tech Line: **270-781-9741**

Footnotes can be found on Pages 66 - 68

- STREET FORCE HEADERS
- CAMARO/FIREBIRD LS1 HEADERS & Y-PIPE
- COMPETITION HEADERS
- MUSTANG GT EXHAUST SYSTEM
- SUPER COMPETITION HEADERS
- RACE HEADERS
- COMPETITION & SUPER COMP EXHAUST KITS
- DIESEL EXHAUST SYSTEMS
- CORBACK SYSTEMS
- MUFFLERS
- EXHAUST TIPS
- COMPONENTS & ACCESSORIES
- HEADER & COLLECTOR GASKETS
- FOOTNOTES
- PHOTO GALLERY
- PART # TO PAGE INDEX
- WARRANTY

STREET FORCE HEADERS
CAMARO/FIREBIRD LS1 HEADERS & Y-PIPE
COMPETITION HEADERS
MUSTANG GT EXHAUST SYSTEM
SUPER COMPETITION HEADERS
RACE HEADERS
COMPETITION & SUPER COMP EXHAUST KITS
DIESEL EXHAUST SYSTEMS
CATBACK SYSTEMS
MUFFLERS
EXHAUST TIPS
COMPONENTS & ACCESSORIES
HEADER & COLLECTOR GASKETS
FOOTNOTES
PHOTO GALLERY
PART # TO PAGE INDEX
WARRANTY

COMPETITION

AMERICAN MOTORS, BUICK & CHEVROLET/GMC

COMPETITION HEADERS

STREET SMART HIGH PERFORMANCE

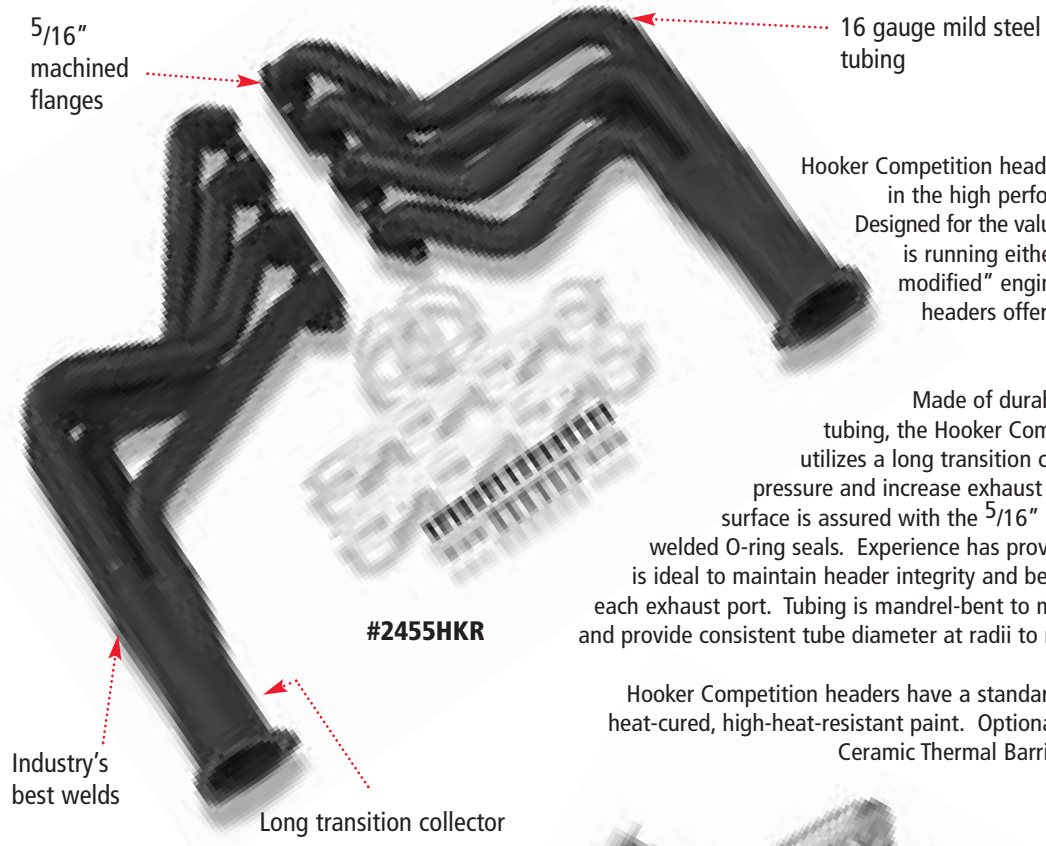

Hooker Competition headers offer the best value in the high performance header market. Designed for the value-conscious buyer who is running either a "stock" or "mildly-modified" engine, Hooker Competition headers offer premium features at a very competitive price.

Made of durable 16 gauge mild steel tubing, the Hooker Competition header design utilizes a long transition collector to reduce back pressure and increase exhaust flow. A perfect sealing surface is assured with the 5/16" machined flanges, with welded O-ring seals. Experience has proven that this flange size is ideal to maintain header integrity and be pliable enough to seal each exhaust port. Tubing is mandrel-bent to maintain metal strength and provide consistent tube diameter at radii to maximize performance.

Hooker Competition headers have a standard finish that features a heat-cured, high-heat-resistant paint. Optionally, the famous Hooker Ceramic Thermal Barrier Coating is available.

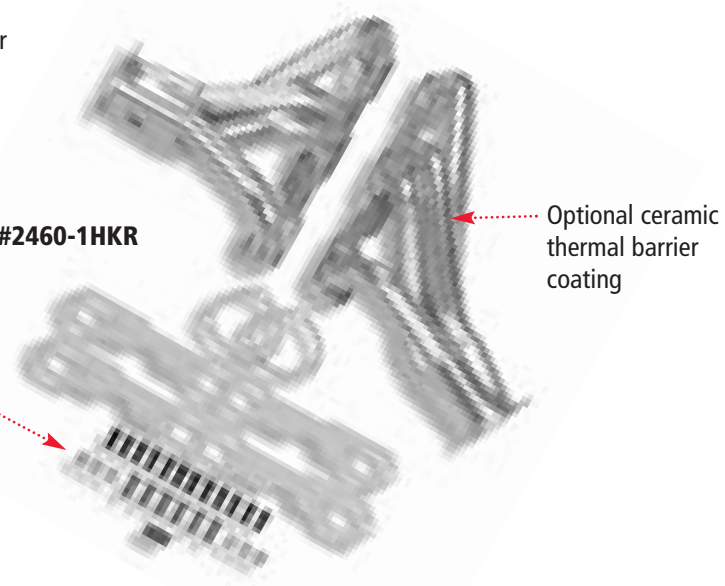

All necessary hardware is included

For additional header applications see Engine Swap Section on pages 23-26

www.ilovemyhookerheaders.com



COMPETITION HEADERS

YEARS	ENGINES	Baked-On Black PAINT	Metallic Ceramic COATING	VIBRATORY POLISHED STAINLESS	EMISSION CODE	FOOTNOTES	TRANSMISSION STANDARD/ AUTO					TUBE SIZE O.D. IN	COLL SIZE O.D. IN	COLL LN IN	PORT SHAPE			
							P/S	P/B	A/C	COL	FL					COL	FL	
AMERICAN MOTORS / JEEP																		
GREMLIN X, HORNET SC																		
72-76	260-401	7901HKR	7901-1HKR	◆	4		Y	Y	Y	N	Y	Y	Y	1 5/8x30	3	8	REC	
JAVELIN, AMX																		
68-74	260-401	7901HKR	7901-1HKR	◆	4		Y	Y	Y	N	Y	Y	Y	1 5/8x30	3	8	REC	
MATADOR																		
74-76	260-401	7901HKR	7901-1HKR	◆	4		Y	Y	Y	N	Y	Y	Y	1 5/8x30	3	8	REC	
SPIRIT																		
79	304	7901HKR	7901-1HKR	◆	4		Y	Y	Y	N	Y	Y	Y	1 5/8x30	3	8	REC	
CHEROKEE, PICKUPS, WAGONEER																		
71-79	304-401	9402HKR	*9402-1HKR	◆	4,90		Y	Y	Y	Y	Y	Y	Y	1 5/8x23	2 1/2	8	REC	
JEEP CJ5, 6, 7																		
72-80	304-401	9401HKR	9401-1HKR	◆	4,84,90,141		Y	Y	Y	N	Y	Y	N	1 5/8x28	3	8	REC	
72-80	304-401	9403HKR	9403-1HKR	◆	4		Y	Y	Y	N	Y	Y	N	1 5/8x23	2 1/2	8	REC	
BUICK																		
REGAL																		
78-87	265-400CH	2451HKR	2451-1HKR	2451-2HKR	◆	2,4,90,117,127	Y	Y	Y	N	N	Y	Y	1 5/8x30	3	8	SAP	
78-87	283-400CH	2466HKR	2466-1HKR		◆	62,111,241,242	Y	Y	9	N	N	Y	Y	1 5/8	3		SAP	
CHEVROLET / GMC																		
PASSENGER, WAGON - (FULL SIZE)																		
55-57	265-400	2458HKR	2458-1HKR	◆	4,21,127,206,232		Y	Y	N	Y	Y	Y	Y	1 5/8x30	3	8	SAP	
65-70	265-400	2451HKR	2451-1HKR	2451-2HKR	◆	2,4,90,117,127	Y	Y	9	Y	Y	Y	Y	1 5/8x30	3	8	SAP	
71-89	265-400	2451HKR	2451-1HKR	2451-2HKR	◆	2,4,90,117,127	Y	Y	9	N	N	Y	Y	1 5/8x30	3	8	SAP	
71-94	283-400	2466HKR	2466-1HKR		◆	62,111,241	Y	Y	9	N	N	Y	Y	1 5/8	3		SAP	
65-70	396-502	2457HKR	2457-1HKR		◆	4,90	Y	Y	Y	Y	Y	Y	Y	2x27	3 1/2	10	SAP	
71-74	396-502	2455HKR	2455-1HKR	2455-2HKR	◆	4,90,266	Y	Y	Y	N	N	Y	N	2x30	3 1/2	10	SAP	
CHEVELLE, EL CAMINO / CABALLERO, SPRINT																		
64-87	265-400	2451HKR	2451-1HKR	2451-2HKR	◆	2,4,90,117,127	Y	Y	9	Y	Y	Y	Y	1 5/8x30	3	8	SAP	
64-87	283-400	2466HKR	2466-1HKR		◆	62,111,241,242	Y	Y	9	N	N	Y	Y	1 5/8	3		SAP	
64-74	396-502	2455HKR	2455-1HKR	2455-2HKR	◆	4,90	Y	Y	Y	Y	Y	Y	Y	2x30	3 1/2	10	SAP	
MONTE CARLO																		
70-87	265-400	2451HKR	2451-1HKR	2451-2HKR	◆	2,4,90,117,127	Y	Y	9	N	N	Y	Y	1 5/8x30	3	8	SAP	
70-87	283-400	2466HKR	2466-1HKR		◆	62,111,241,242	Y	Y	9	N	N	Y	Y	1 5/8	3		SAP	
70-74	396-502	2455HKR	2455-1HKR	2455-2HKR	◆	4,90,266	Y	Y	Y	N	N	Y	Y	2x30	3 1/2	10	SAP	
CHEVY II, NOVA																		
68-79	265-400	2451HKR	2451-1HKR	2451-2HKR	◆	2,4,90,117,127	Y	Y	9	Y	Y	Y	Y	1 5/8x30	3	8	SAP	
68-79	283-400	2466HKR	2466-1HKR		◆	62,111,241,242	N	Y	N	N	N	Y	Y	1 5/8	3		SAP	
68-74	396-502	2457HKR	2457-1HKR		◆	4,90,184	Y	Y	Y	Y	Y	Y	Y	2x30	3 1/2	10	SAP	
CAMARO																		
67-69	265-400	2451HKR	2451-1HKR	2451-2HKR	◆	2,4,90,117,127	Y	Y	9	N	Y	Y	Y	1 5/8x30	3	8	SAP	
67-69	396-502	2457HKR	2457-1HKR		◆	4,90,184	Y	Y	Y	N	Y	Y	Y	2x27	3 1/2	10	SAP	
67-81	283-400	2466HKR	2466-1HKR		◆	62,111,241,242	Y	Y	N	N	N	Y	Y	1 5/8	3		SAP	
70-81	265-400	2451HKR	2451-1HKR	2451-2HKR	◆	2,4,90,117,127	Y	Y	9	N	Y	Y	Y	1 5/8x30	3	8	SAP	
82-92	265-400	2460HKR	2460-1HKR	2460-2HKR	◆	2,4,62,92,252	Y	Y	Y	N	Y	N	Y	1 5/8	3	4	SAP	
82-92	Mid-length F-body		16767HKR		◆	256								Y-pipe for 2460HKR				
70-72	396-502	2455HKR	2455-1HKR	2455-2HKR	◆	4,90,148	Y	Y	Y	N	Y	N	Y	2x30	3 1/2	10	SAP	
NEW	98-99	350 LS1	2468HKR	2468-1HKR	2468-2HKR	◆	4,94,172,234,236	Y	Y	Y	N	Y	N	Y	1 3/4x32	3	10	SAP
NEW	00-02	350 LS1	2469HKR	2469-1HKR	2469-2HKR	◆	4,94,172,234,236	Y	Y	Y	N	Y	N	Y	1 3/4x32	3	10	SAP
NEW	98-02	350 LS1	16723HKR	16723-1HKR	16723-2HKR	◆	Y-pipe for 2468HKR/2468-1HKR/2468-2HKR/2469-HKR/2469-1HKR/2469-2HKR											
CORVETTE																		
55-82	265-400	2456HKR	2456-1HKR		◆	22,127,133	Y	Y	9	N	Y	N	Y	1 5/8x24	3	8	SAP	

Tech Line: 270-781-9741

Footnotes can be found on
Pages 66 - 68

STREET FORCE HEADERS

CAMARO/FIBERGLASS HEADERS & Y-PIPE

COMPETITION HEADERS

MUSTANG GT EXHAUST SYSTEM

SUPER COMPETITION HEADERS

RACE HEADERS

COMPETITION & SUPER COMP EXHAUST KITS

DIESEL EXHAUST SYSTEMS

CATBACK SYSTEMS

MUFFLERS

EXHAUST TIPS

COMPONENTS & ACCESSORIES

HEADER & COLLECTOR GASKETS

FOOTNOTES

PHOTO GALLERY

PART # TO PAGE INDEX

WARRANTY

STREET FORCE HEADERS
CAMARO/ FIREBIRD LS1 HEADERS & Y-PIPE
COMPETITION HEADERS
MUSTANG GT EXHAUST SYSTEM
SUPER COMPETITION HEADERS
RACE HEADERS
COMPETITION & SUPER COMP EXHAUST KITS
DIESEL EXHAUST SYSTEMS
CATBACK SYSTEMS
MUFFLERS
EXHAUST TIPS
COMPONENTS & ACCESSORIES
HEADER & COLLECTOR GASKETS
FOOTNOTES
PHOTO GALLERY
PART # TO PAGE INDEX
WARRANTY

COMPETITION

CHEVROLET/GMC, DODGE/PLYMOUTH & FORD/MERCURY

COMPETITION HEADERS

YEARS	ENGINES	Baked-On Black PAINT	Metallic Ceramic COATING	VIBRATORY POLISHED STAINLESS	EMISSION CODE	FOOTNOTES	TRANSMISSION STANDARD/ AUTO				TUBE SIZE O.D. IN	COLL SIZE O.D. IN	COLL LN IN	PORT SHAPE			
							P/S	P/B	A/C	COL					FL	COL	FL
BLAZER, SUBURBAN / JIMMY, CARRYALL, YUKON, 1-TON CREW CAB (2WD)																	
69-72	265-400	2452HKR	2452-1HKR	2452-2HKR	◆	2,117,127,253	Y	Y	Y	Y	Y	Y	N	1 5/8x27	2 1/2	8	SAP
73-91	265-400	2452HKR	2452-1HKR	2452-2HKR	◆	2,117,127,253	Y	Y	Y	Y	Y	Y	N	1 5/8x27	2 1/2	8	SAP
92-96	265-400	2462HKR	2462-1HKR	2462-2HKR	◆	4,90,92	Y	Y	Y	N	N	Y	N	1 5/8x31	2 1/2	8	SAP
73-91	396-502	2454HKR	2454-1HKR	2454-2HKR	◆	4,90	Y	Y	Y	N	Y	Y	N	1 5/8x31	2 1/2	8	SAP
92-95	396-502	2461HKR	2461-1HKR		◆	4,90,92	Y	Y	Y	N	N	Y	N	1 3/4x30	3	8	SAP
S-10, BLAZER / S-15, JIMMY (2WD)																	
88-93	V-6 4.3L	2464HKR	2464-1HKR		◆	4		Y	Y	Y	Y	Y	Y	1 1/2x27	2 1/2	5 1/2	SAP
1/2, 3/4, 1 TON TRUCK (2WD)																	
63-72	265-400	2452HKR	2452-1HKR	2452-2HKR	◆	2,53,117,127,253	Y	Y	Y	Y	Y	Y	N	1 5/8x27	2 1/2	8	SAP
73-87	265-400	2452HKR	2452-1HKR	2452-2HKR	◆	2,53,117,127,253	Y	Y	Y	Y	Y	Y	N	1 5/8x27	2 1/2	8	SAP
68-87	396-502	2454HKR	2454-1HKR	2454-2HKR	◆	4,90,130	Y	Y	Y	N	Y	Y	N	1 3/4x30	3	8	SAP
1500, 2500, 3500 TRUCK (2WD)																	
88-98	265-400	2462HKR	2462-1HKR	2462-2HKR	◆	4,90,92	Y	Y	Y	N	N	Y	N	1 5/8x31	2 1/2	8	SAP
92-95	396-502	2461HKR	2461-1HKR		◆	4,90,92	Y	Y	Y	N	N	Y	N	1 3/4x30	3	8	SAP
BLAZER / JIMMY, YUKON, TAHOE 2DR (4WD)																	
69-72	265-400	2453HKR	2453-1HKR		◆	2,117,127	Y	Y	9	N	Y	Y	N	1 5/8x27	2 1/2	8	SAP
73-91	265-400	2453HKR	2453-1HKR		◆	2,117,127	Y	Y	9	N	Y	Y	N	1 5/8x27	2 1/2	8	SAP
92-96	265-400	2462HKR	2462-1HKR	2462-2HKR	◆	4,90,92	Y	Y	Y	N	N	Y	N	1 5/8x31	2 1/2	8	SAP
69-91	396-502	2463HKR	2463-1HKR		◆	4,117,121	Y	Y	Y	N	Y	Y	N	1 3/4x31	3	8	SAP
S-10, BLAZER / S-15, JIMMY (4WD)																	
88-93	V-6 4.3L	2465HKR	*2465-1HKR		◆	4		Y	Y	Y	N	Y	Y	1 1/2x30	2 1/2	8	SAP
1/2, 3/4, 1 TON TRUCK (4WD)																	
67-72	265-400	2453HKR	2453-1HKR		◆	2,4,90,127	Y	Y	9	N	Y	Y	N	1 5/8x27	2 1/2	8	SAP
73-87	265-400	2453HKR	2453-1HKR		◆	2,90,117,127	Y	Y	9	N	Y	Y	N	1 5/8x27	2 1/2	8	SAP
69-87	396-502	2463HKR	2463-1HKR		◆	4,117,121	Y	Y	Y	N	Y	Y	N	1 3/4x31	3	8	SAP
1500, 2500, 3500 TRUCK (4WD)																	
88-98	265-400	2462HKR	2462-1HKR	2462-2HKR	◆	4,90,92	Y	Y	Y	N	N	Y	N	1 5/8x31	2 1/2	8	SAP
92-95	396-502	2461HKR	2461-1HKR		◆	4,90,92	Y	Y	Y	N	N	Y	N	1 3/4x30	3	8	SAP
VAN, MINI-MOTORHOMES - CLASS A																	
68-95	396-502	2454HKR	2454-1HKR		◆	2,4,117,127	Y	Y	Y	N	Y	Y	N	1 3/4x30	3	8	SAP
VAN, MINI-MOTORHOMES - CLASS C																	
71-89	265-400	2459HKR	2459-1HKR		◆	117,127	Y	Y	Y	Y	N	Y	N	1 5/8x29	2 1/2	8	SAP
DODGE / PLYMOUTH																	
PASSENGER, WAGON (B & E Bodies)																	
67-74	383-440	5903HKR	5903-1HKR		◆	4,10,90,200	Y	Y	Y	Y	Y	Y	Y	1 7/8x36	3	8	SAP
CHALLENGER / BARRACUDA																	
70-74	383-440	5903HKR	5903-1HKR		◆	4,10,90,200	Y	Y	Y	Y	Y	Y	Y	1 7/8x36	3	8	SAP
CHRYSLER CORDOBA																	
75	400	5903HKR	5903-1HKR		◆	4,10,90	Y	Y	Y	N	N	N	Y	1 7/8x36	3	8	SAP
ALL B & E (A & F Bodies)																	
67-82	273-360	5901HKR	5901-1HKR		◆	4,10,90,201	Y	Y	Y	N	Y	Y	Y	1 5/8x34	3	8	SAP
1/2, 3/4 TON PICKUP (2&4WD)																	
72-93	318-360	5902HKR	5902-1HKR		◆	10,117,201	Y	Y	Y	Y	Y	Y	N	1 5/8x31	2 1/2	8	SAP
1/2, 3/4 TON PICKUP (4WD)																	
75-78	440	5905HKR	5905-1HKR		◆	4,200	Y	Y	Y	N	Y	Y	N	1 3/4x27	2 1/2	8	SAP
RAMCHARGER / TRAILDUSTER																	
74-93	318-360	5902HKR	5902-1HKR		◆	10,124,201	Y	Y	Y	N	Y	Y	N	1 5/8x31	2 1/2	8	SAP
74-78	440	5905HKR	5905-1HKR		◆	4,200	Y	Y	Y	N	Y	Y	N	1 3/4x27	2 1/2	8	SAP

For additional header applications see Engine Swap Section on pages 23-26

www.ilovemyhookerheaders.com



COMPETITION HEADERS

YEARS	ENGINES	Baked-On Black PAINT	Metallic Ceramic COATING	VIBRATORY POLISHED STAINLESS	EMISSION CODE	FOOTNOTES	P/S	P/B	A/C	TRANSMISSION STANDARD/ AUTO				TUBE SIZE O.D. IN	COLL SIZE O.D. IN	COLL LN IN	PORT SHAPE
										COL	FL	COL	FL				
FORD / MERCURY																	
FALCON, FAIRLANE, TORINO, RANCHERO, CYCLONE, MONTEGO																	
66-73	255-302W	6901HKR	6901-1HKR	6901-2HKR	◆	4,68,226	83	Y	Y	N	Y	Y	Y	1 5/8x28	3	8	SAP
67-70	351C	6920HKR	6920-1HKR		◆	4,29	83	Y	Y	N	Y	N	Y	1 3/4x32	3	8	SAP
70-71	351C	6913HKR	6913-1HKR		◆	4,33	N	Y	Y	N	N	N	Y	1 3/4x32	3	8	SAP
70-71	351C	6915HKR	6915-1HKR		◆	4,29,226	Y	N	Y	N	N	Y	N	1 3/4x27	3	8	SAP
71-73	351C	6921HKR	6921-1HKR		◆	4,33	Y	Y	Y	N	Y	Y	Y	1 3/4x28	3	8	SAP
72-73	351C	6915HKR	6915-1HKR		◆	4,29,226	Y	Y	Y	N	Y	Y	Y	1 3/4x27	3	8	SAP
MUSTANG / COUGAR																	
64-73	255-302W	6901HKR	6901-1HKR	6901-2HKR	◆	4,226,68,77	83	Y	Y	N	Y	N	Y	1 5/8x28	3	8	SAP
67-70	351C	6913HKR	6913-1HKR		◆	4,33	83	Y	Y	N	Y	N	Y	1 3/4x32	3	8	SAP
67-70	351C	6920HKR	6920-1HKR		◆	4,29	83	Y	Y	N	Y	N	Y	1 3/4x32	3	8	SAP
71-73	351C	6915HKR	6915-1HKR		◆	4,29,226	Y	Y	Y	N	Y	Y	Y	1 3/4x27	3	8	SAP
71-73	351C	6921HKR	6921-1HKR		◆	4,33	Y	Y	Y	N	Y	Y	Y	1 3/4x28	3	8	SAP
MUSTANG, FAIRLANE / COUGAR																	
67-73	351W	6901HKR	6901-1HKR	6901-2HKR	◆	4,226,68	83	Y	Y	N	N	N	Y	1 5/8x28	3	8	SAP
COMET																	
66-69	255-302W	6901HKR	6901-1HKR	6901-2HKR	◆	4,226,68	83	Y	Y	N	Y	N	Y	1 5/8x28	3	8	SAP
MAVERICK																	
70-77	255-302W	6901HKR	6901-1HKR	6901-2HKR	◆	4,226,68	83	Y	Y	N	Y	N	Y	1 5/8x28	3	8	SAP
F-100, F150, F-250 (2WD)																	
65-76	352-390	6903HKR	6903-1HKR		◆	224	Y	Y	Y	Y	Y	Y	N	1 3/4x24	2 1/2	9	SAP
77 1/2-79	351-400M	6914HKR	6914-1HKR		◆	4	Y	Y	Y	N	Y	Y	N	1 3/4x33	3	8	SAP
F-350 (2WD) - excluding camper special																	
67-75	352-390	6903HKR	6903-1HKR		◆	4,90,224	Y	Y	Y	Y	Y	Y	N	1 3/4x24	2 1/2	9	SAP
F-250 (4WD)																	
67-76	352-390	6905HKR	*6905-1HKR		◆	4,90,224	Y	Y	Y	N	Y	Y	N	1 3/4x27	2 1/2	8	SAP
F-100, F-150 (4WD)																	
69-76	352-390	6906HKR	*6906-1HKR		◆	4,90,224	Y	Y	Y	N	Y	Y	N	1 3/4x26	2 1/2	9	SAP
F-100, F-150 (2WD)																	
69-79	255-302W	6904HKR	6904-1HKR		◆	4,49	Y	Y	Y	Y	Y	Y	N	1 5/8x21	2 1/2	9	SAP
F-100, F-150, F-250 (2WD)																	
80-87	460	6911HKR	6911-1HKR		◆	4,117	Y	Y	Y	Y	N	Y	N	1 3/4x28	3	8	SAP
BRONCO (4WD)																	
66-77	255-351W	6909HKR	6909-1HKR		◆	4,49,90,223	Y	Y	Y	Y	Y	Y	Y	1 1/2x20	2 1/2	8	SAP
78-79	351-400M	6902HKR	6902-1HKR		◆	4,90	Y	Y	Y	N	Y	Y	N	1 3/4x27	3	8	SAP
80-86	351-400M	6916HKR	*6916-1HKR		◆	4,117	Y	Y	Y	N	N	Y	N	1 3/4x29	2 1/2	8	SAP
80-95	255-302W	6907HKR	6907-1HKR		◆	4,68,117	Y	Y	Y	N	N	Y	N	1 1/2x32	2 1/2	8	SAP
80-95	351W	6912HKR	6912-1HKR		◆	4,49,117	Y	Y	Y	N	Y	Y	N	1 1/2x27	2 1/2	8	SAP
F-150 (4WD)																	
77-79	351-400M	6902HKR	*6902-1HKR		◆	4,90	Y	Y	Y	N	Y	Y	N	1 3/4x27	3	8	SAP
F-250 LOW PROFILE, F-350 (4WD)																	
77 1/2-79	351-400M	6902HKR	*6902-1HKR		◆	4,90	Y	Y	Y	N	Y	Y	N	1 3/4x27	3	8	SAP

- STREET FORCE HEADERS
- CAMARO/FIBERGLASS HEADERS & Y-PIPE
- COMPETITION HEADERS
- MUSTANG GT EXHAUST SYSTEM
- SUPER COMPETITION HEADERS
- RACE HEADERS
- COMPETITION & SUPER COMP EXHAUST KITS
- DIESEL EXHAUST SYSTEMS
- CATBACK SYSTEMS
- MUFFLERS
- EXHAUST TIPS
- COMPONENTS & ACCESSORIES
- HEADER & COLLECTOR GASKETS
- FOOTNOTES
- PHOTO GALLERY
- PART # TO PAGE INDEX
- WARRANTY

Tech Line: 270-781-9741

Footnotes can be found on Pages 66 - 68

STREET FORCE HEADERS
CAMARO/ FIREBIRD LS1 HEADERS & Y-PIPE
COMPETITION HEADERS
MUSTANG GT EXHAUST SYSTEM
SUPER COMPETITION HEADERS
RACE HEADERS
COMPETITION & SUPER COMP EXHAUST KITS
DIESEL EXHAUST SYSTEMS
CATBACK SYSTEMS
MUFFLERS
EXHAUST TIPS
COMPONENTS & ACCESSORIES
HEADER & COLLECTOR GASKETS
FOOTNOTES
PHOTO GALLERY
PART # TO PAGE INDEX
WARRANTY

COMPETITION

FORD, OLDSMOBILE, PONTIAC & TOYOTA

COMPETITION HEADERS

YEARS	ENGINES	Baked-On Black PAINT	Metallic Ceramic COATING	VIBRATORY POLISHED STAINLESS	EMISSION CODE	FOOTNOTES	TRANSMISSION STANDARD/ AUTO					TUBE SIZE O.D. IN	COLL SIZE O.D. IN	COLL LN IN	PORT SHAPE			
							P/S	P/B	A/C	COL	FL					COL	FL	
F-250, F-350 (4WD)																		
83-87	460	6911HKR	6911-1HKR		◆	4,117	Y	Y	Y	Y	Y	Y	Y	Y	1 3/4x30	3	8	SAP
F-100, F-150, F-250, F-350 (2&4WD)																		
80-95	255-302W	6907HKR	6907-1HKR		◆	4,68,90,117	Y	Y	Y	N	N	Y	N		1 1/2x32	2 1/2	8	SAP
80-95	351W	6912HKR	6912-1HKR		◆	4,49,117	Y	Y	Y	N	Y	Y	N		1 1/2x27	2 1/2	8	SAP
80-86	351-400M	6916HKR	*6916-1HKR		◆	4,117	Y	Y	Y	N	N	Y	N		1 3/4x29	2 1/2	8	SAP
VAN, MINI-MOTORHOME - CLASS C																		
69-90	255-351W	6910HKR	*6910-1HKR		◆	4,68,75,90	Y	Y	Y	Y	N	Y	N		1 5/8x34	2 1/2	8	SAP

OLDSMOBILE

CUTLASS/442																		
65-75	400-455	3902HKR	3902-1HKR		◆	4,214	Y	Y	Y	N	Y	Y	Y		1 3/4x27	3	8	SAP
68-77	350-403	3901HKR	3901-1HKR		◆	4,90,214	Y	Y	Y	N	Y	Y	N		1 5/8x29	2 1/2	8	SAP
78-87	265-400CH	2451HKR	2451-1HKR	2451-2HKR	◆	2,4,90,117,127	Y	Y	Y	N	N	Y	Y		1 5/8x30	3	8	SAP
78-87	283-400CH	2466HKR	2466-1HKR		◆	62,111,241,242	Y	Y	9	N	N	Y	Y		1 5/8	3		SAP

DELTA 88																		
71-75	400-455	3902HKR	3902-1HKR		◆	4	Y	Y	Y	N	N	Y	Y		1 3/4x27	3	8	SAP

VISTA CRUISER WAGON																		
71-74	400-455	3902HKR	3902-1HKR		◆	4	Y	Y	Y	N	N	Y	Y		1 3/4x27	3	8	SAP

PONTIAC

FIREBIRD, TRANS AM																		
67-69	350-400	4902HKR	4902-1HKR		◆	4,126	Y	Y	Y	N	Y	N	Y		1 5/8x26	3	8	SAP
70-79	350-455	4901HKR	4901-1HKR		◆	4,90,126	Y	Y	Y	N	Y	N	Y		1 5/8x28	3	8	SAP
77-78	350-403OL	3901HKR	3901-1HKR		◆	4,90	Y	Y	Y	N	Y	N	Y		1 5/8x29	2 1/2	8	SAP
78-81	265-400CH	2451HKR	2451-1HKR	2451-2HKR	◆	2,4,90,117,127	Y	Y	9	N	Y	Y	Y		1 5/8x30	3	8	SAP
82-92	265-400CH	2460HKR	2460-1HKR	2460-2HKR	◆	2,4,62,92,252	Y	Y	Y	N	Y	N	Y		1 5/8x15	3	4	SAP
NEW 98-99	350 LS1	2468HKR	2468-1HKR	2468-2HKR	◆	4,94,172,234,236	Y	Y	Y	N	Y	N	Y		1 3/4x32	3	10	SAP
NEW 00-02	350 LS1	2469HKR	2469-1HKR	2469-2HKR	◆	4,94,172,234,236	Y	Y	Y	N	Y	N	Y		1 3/4x32	3	10	SAP
NEW 98-02	350 LS1	16723HKR	16723-1HKR	16723-2HKR	◆	Y-pipe for 2468HKR/2468-1HKR/2468-2HKR/2469-HKR/2469-1HKR/2469-2HKR												

GTO, LE MANS, GRAND AM																		
64-75	326-455	4901HKR	4901-1HKR		◆	4,90	Y	Y	Y	N	Y	Y	Y		1 5/8x28	3	8	SAP

PHOENIX, VENTURA, GRAND PRIX																		
77-87	265-400CH	2451HKR	2451-1HKR	2451-2HKR	◆	2,4,90,117,127	Y	Y	9	N	Y	Y	Y		1 5/8x30	3	8	SAP

TOYOTA

PICKUP (2&4WD)																		
75-88	20R/22R	8900HKR	*8900-1HKR		◆	4,56,117	Y	Y	Y	N	Y	Y	Y		1 1/2x18	2 1/2	8	RD

Y=Yes N=No SAP=Same as Port RD=Round REC=Rectangle

TIP: Breaking in an engine with ceramic coated headers WILL result in damage to the coating and will VOID all warranties. Ceramic coated headers require several heat cycles to fully cure before they will withstand extreme heat. Hooker recommends using cast iron exhaust manifolds or old headers to break in new engines to avoid coating damage. Please call Hooker tech service at 270-781-9741 for additional information regarding ceramic coated exhaust products.

For additional header applications see Engine Swap Section on pages 23-26

www.ilovemyhookerheaders.com



HOOKER Mustang GT Exhaust! 2005-Present

**14.2 HP &
21.9 lb/ft**
over stock
exhaust!

HOOKER EXHAUST vs. STOCK EXHAUST



Legend:
 Hooker Exhaust
 Stock Exhaust
 Hooker Headers

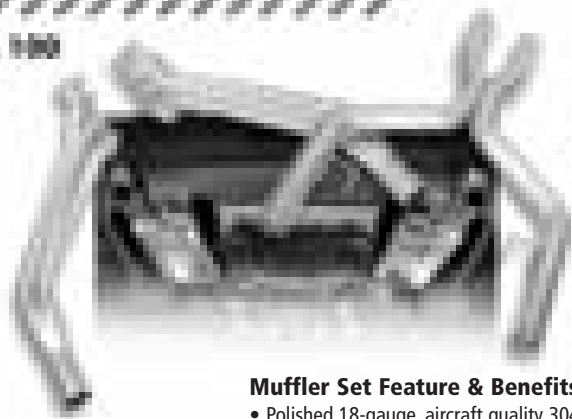

Header & Cross-pipe Feature & Benefits

- Full length header design for maximum performance
- 1-5/8" mandrel-bent tuned length primary tubes for decreased backpressure & increased exhaust velocity
- 2.5" x 9" smooth transition slip-fit collector is aligned for easy installation
- 3/8" machined flange for perfect sealing surface
- Lightweight 16-gauge mild steel tubing for strength & reliability
- O₂ bungs for stock emissions connections
- Precision-matched header gaskets
- All the necessary hardware is included for installation

Muffer Set Feature & Benefits

- Polished 18-gauge, aircraft quality 304 stainless steel for lightweight, long life and high style
- Cases are fully welded for strength and to prevent annoying "drumming" harmonics at highway speeds
- Vibratory-polished P-clamp connectors for an attractive, leak-free seal
- Aerodynamically designed internal chambers for the lowest backpressure and reduced turbulence

Part #	Description
6233HKR	Super Comp full length header, 2005-present Mustang GT, 4.6L V8, painted
6233-1HKR	Super Comp full length header, 2005-present Mustang GT, 4.6L V8, coated
16684HKR	High performance Cross-pipe, 2005-Present Mustang GT, 304 Stainless Steel
21521HKR	2005-Present Mustang GT, Aero Chamber muffer set, stainless Steel
21523HKR	2005-Present Mustang GT, Aero Chamber muffer set, aluminized steel w/o tips, black

Tech Line: 270-781-9741

Footnotes can be found on
Pages 66 - 68

- STREET FORCE HEADERS
- CAMARO/FIBERD LSI HEADERS & Y-PIPE
- COMPETITION HEADERS
- MUSTANG GT EXHAUST SYSTEM
- SUPER COMPETITION HEADERS
- RACE HEADERS
- COMPETITION & SUPER COMP EXHAUST KITS
- DIESEL EXHAUST SYSTEMS
- CATBACK SYSTEMS
- MUFFLERS
- EXHAUST TIPS
- COMPONENTS & ACCESSORIES
- HEADER & COLLECTOR GASKETS
- FOOTNOTES
- PHOTO GALLERY
- PART # TO PAGE INDEX
- WARRANTY

STREET FORCE HEADERS
CAMARO/FIREBIRD LS1 HEADERS & Y-PIPE
COMPETITION HEADERS
MUSTANG GT EXHAUST SYSTEM
SUPER COMPETITION HEADERS
RACE HEADERS
COMPETITION & SUPER COMP EXHAUST KITS
DIESEL EXHAUST SYSTEMS
CATBACK SYSTEMS
MUFFLERS
EXHAUST TIPS
COMPONENTS & ACCESSORIES
HEADER & COLLECTOR GASKETS
FOOTNOTES
PHOTO GALLERY
PART # TO PAGE INDEX
WARRANTY

SUPER COMPETITION

AMERICAN MOTORS & BUICK

HOOKER SUPER COMP HEADERS

When Only The Best Will Do!

5/16" machined flanges

Lightweight 18 gauge mild steel tubing

Mandrel bent tuned length primaries for decreased backpressure & increased exhaust velocity

O₂ bungs (where applicable)

Hooker Super Competition header gaskets

Industry's best welds for durability

Long transition collectors reduce backpressure

All necessary hardware for a simple installation

#6228-1HKR

With Hooker Super Competition, the objective has always been to make the maximum horsepower possible and to put it at the optimum point in the power curve. Because of the immense complexity of a modern engine and vehicle combination, there are no simple quick answers. It takes a lot of time and money to do the job right. We will sometimes spend up to 2 to 3 times more just to make the Super Competition headers work only 5 to 10% better. That commitment to excellence has made Hooker Headers the winningest header manufacturer in automotive drag racing history.

With applications ranging from 50 state legal headers for a Mustang to stepped headers for Pro Stock cars, you can bet Hooker Headers has a header that will make your car quicker, faster and lighter.

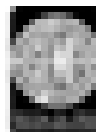

For additional header applications see Engine Swap Section on pages 23-26

www.ilovemyhookerheaders.com



SUPER COMPETITION FULL LENGTH CAR HEADERS

With Hooker Super Competition, the objective has always been to make the maximum horsepower and to put it at the optimum point in the power curve. It takes a lot of time and money to do the job right. We will sometimes spend up to 2 to 3 times more just to make the Super Competition header work only 5 to 10% better. That commitment to excellence has made Hooker Headers the winningest header manufacturer in automotive drag racing history.

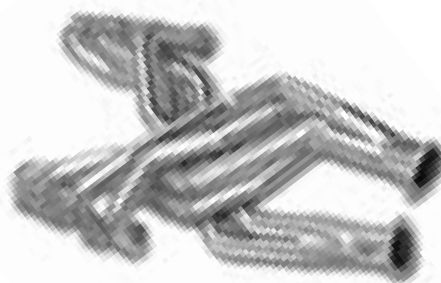

Years	Engines	Baked-On Black Paint	Metallic Ceramic Coating	EMISSION CODE	FOOTNOTES	P/S	P/B	A/C	TRANSMISSION STANDARD/AUTO				TUBE SIZE O.D. IN	COLL SIZE O.D. IN	COLL LN IN	PORT SHAPE	
									COL	FL	COL	FL					
AMERICAN MOTORS																	
GREMLIN X																	
72-74	290-401	7105HKR	*7105-1HKR	◆	4,123		Y	Y	Y	Y	Y	Y	Y	1 3/4x32	3	10	SAP
72-75	290-401	7104HKR	7104-1HKR	◆	4		Y	Y	Y	Y	Y	Y	Y	1 5/8x30	3	8	REC
AMX SPIRIT																	
79-80	304	7104HKR	7104-1HKR	◆	4		Y	Y	Y	N	Y	Y	Y	1 5/8x30	3	8	REC
HORNET SC																	
70-74	290-401	7105HKR	*7105-1HKR	◆	4,123		Y	Y	Y	Y	Y	17	17	1 3/4x32	3	10	SAP
72-76	290-401	7104HKR	7104-1HKR	◆	4		Y	Y	Y	Y	Y	Y	Y	1 5/8x30	3	8	REC
JAVELIN AMX																	
68-74	290-401	7103HKR	7103-1HKR	◆	4,123,292		Y	Y	Y	Y	Y	Y	Y	1 7/8x30	3 1/2	10	SAP
68-74	290-401	7104HKR	7104-1HKR	◆	4		Y	Y	Y	Y	Y	Y	Y	1 5/8x30	3	8	REC
MATADOR																	
74	290-401	7103HKR	7103-1HKR	◆	4,123,292		Y	Y	Y	Y	Y	Y	Y	1 7/8x30	3 1/2	10	SAP
74-76	290-401	7104HKR	7104-1HKR	◆	4		Y	Y	Y	Y	Y	Y	Y	1 5/8x30	3	8	REC
BUICK																	
GRAND NATIONAL, REGAL T-TYPE (Stock turbo only)																	
86-87	3.8L Turbo		1115HKR	◆	4,15,74,78,147		Y	Y	Y	N	Y	Y	Y	1 1/2x13	2 1/4	7	SAP
APOLLO																	
68-74	250CH	2602HKR	2602-1HKR	◆	4		N	Y	Y	Y	Y	Y	Y	1 5/8x39	2 1/2	8	SAP
CENTURY, REGAL, WAGONS																	
73-76	350	1103HKR	*1103-1HKR	◆	4		Y	Y	Y	Y	Y	Y	Y	1 3/4x28	3	10	SAP
77	350-403OL	3107HKR	3107-1HKR	◆	4		Y	Y	Y	Y	Y	Y	Y	1 3/4x30	3	10	SAP
78-87	265-400CH	2150HKR	2150-1HKR	◆	4,62,117,211		Y	Y	Y	N	N	Y	Y	1 5/8x30	3	10	SAP
78-87	265-400CH	2242HKR	2242-1HKR	◆	4,18,62,117,211		Y	Y	Y	N	N	Y	Y	1 3/4x30	3	10	SAP
SKYLARK, GRAN SPORT, WAGONS																	
68-72	350	1103HKR	*1103-1HKR	◆	4		Y	Y	Y	Y	Y	Y	Y	1 3/4x28	3	10	SAP
68-72	400-455	1203HKR	*1203-1HKR	◆	4		Y	Y	Y	N	Y	Y	Y	1 7/8x32	3	10	SAP

Tech Line: 270-781-9741

Footnotes can be found on Pages 66 - 68

13

- STREET FORCE HEADERS
- CAMARO/FIBERD LSI HEADERS & Y-PIPE
- COMPETITION HEADERS
- MUSTANG GT EXHAUST SYSTEM
- SUPER COMPETITION HEADERS
- RACE HEADERS
- COMPETITION & SUPER COMP EXHAUST KITS
- DIESEL EXHAUST SYSTEMS
- CORBACK SYSTEMS
- MUFFLERS
- EXHAUST TIPS
- COMPONENTS & ACCESSORIES
- HEADER & COLLECTOR GASKETS
- FOOTNOTES
- PHOTO GALLERY
- PART # TO PAGE INDEX
- WARRANTY

SUPER COMPETITION

CHEVROLET, CHRYSLER & DODGE



- STREET FORCE HEADERS
- CAMARO/ FIREBIRD LS1 HEADERS & Y-PIPE
- COMPETITION HEADERS
- MUSTANG GT EXHAUST SYSTEM
- SUPER COMPETITION HEADERS
- RACE HEADERS
- COMPETITION & SUPER COMP EXHAUST KITS
- DIESEL EXHAUST SYSTEMS
- CATBACK SYSTEMS
- MUFFLERS
- EXHAUST TIPS
- COMPONENTS & ACCESSORIES
- HEADER & COLLECTOR GASKETS
- FOOTNOTES
- PHOTO GALLERY
- PART # TO PAGE INDEX
- WARRANTY

YEARS	ENGINES	Baked-On Black PAINT	Metallic Ceramic COATING	VIBRATORY POLISHED STAINLESS	EMISSION CODE	FOOTNOTES	TRANSMISSION STANDARD/ AUTO.					TUBE SIZE O.D. IN	COLL SIZE O.D. IN	COLL LN IN	PORT SHAPE		
							P/S	P/B	A/C	COL	FL					COL	FL
CHEVROLET																	
CAMARO																	
67-74	250	2602HKR	*2602-1HKR	◆	4		N	Y	Y	N	Y	Y	Y	1 5/8x39	2 1/2	8	SAP
67-69	265-400	2130HKR	2130-1HKR	◆	4,62,259,288		Y	Y	9	N	Y	Y	Y	1 5/8x29	3	10	SAP
67-69	265-400	2131HKR	2131-1HKR	◆	4,62,212,288		Y	Y	N	N	Y	Y	Y	1 3/4x30	3	10	SAP
67-69	265-400	2207HKR	2207-1HKR	◆	4,62		Y	Y	N	N	Y	Y	Y	1 7/8x30	3 1/2	10	REC
67-69	396-502	2111HKR	2111-1HKR	◆	4,184,265		Y	Y	N	N	Y	Y	Y	1 7/8x33	3 1/2	10	SAP
67-69	396-502	2205HKR	2205-1HKR	◆	4,184		Y	Y	Y	N	Y	Y	Y	2x33	3 1/2	10	SAP
67-69	396-502	2285HKR	2285-1HKR	◆	4,184,289		N	Y	N	N	Y	Y	Y	2 1/8x36	3 1/2	10	RD
67-69	350 LS1	2288HKR	2288-1HKR	◆	4,283,284		Y	Y	Y	Y	Y	Y	Y	1 3/4x30	3	10	SAP
70-72	265-400	2124HKR	2124-1HKR	◆	4,90,127		Y	Y	9	N	Y	Y	Y	1 5/8x31	3	10	REC
70-81	265-400	2136HKR	2136-1HKR	◆	4,90,117,127		Y	Y	9	N	Y	Y	Y	1 5/8x30	3	10	REC
70-81	265-400	2117HKR	2117-1HKR	◆	4,62,90,117		Y	Y	9	N	Y	Y	Y	1 3/4x32	3	10	SAP
70-81	265-400	2239HKR	2239-1HKR	◆	4,62		Y	Y	N	N	Y	Y	Y	1 7/8x29	3 1/2	10	SAP
70-72	396-502	2118HKR	2118-1HKR	◆	4,184		Y	Y	Y	N	Y	Y	Y	1 3/4x30	3	10	SAP
70-72	396-502	2250HKR	2250-1HKR	◆	4,184		Y	Y	Y	N	Y	Y	Y	1 7/8x35	3 1/2	10	SAP
70-72	396-502	2287HKR	2287-1HKR	◆	4,184,289		Y	Y	N	N	Y	Y	Y	2 1/8x32	3 1/2	10	RD
70-72	396-502	2217HKR	2217-1HKR	◆	4,184		Y	Y	Y	N	Y	Y	Y	2x35	3 1/2	10	SAP
78-81	V6 90°	2143HKR	*2143-1HKR	◆	4,117		Y	Y	Y	N	Y	Y	Y	1 1/2x30	2 1/2	8	SAP
82-92	265-400	2210HKR	2210-1HKR	◆	4,62,117		Y	Y	Y	N	Y	Y	Y	1 3/4x28	3	6 1/2	SAP
93-97	265-400	2231HKR	2231-1HKR	◆	62,90,117,238,258		Y	Y	Y	N	Y	N	Y	1 3/4x30	3	10	SAP
93-97	265-400		16765HKR		Y-pipe for 2231HKR												
NEW 98-99	350 LS-1	2290HKR	*2290-1HKR	◆	2290-2HKR	4,172,236,234,280	Y	Y	Y	N	Y	N	Y	1 7/8x32	3	10	SAP
NEW 00-02	350 LS-1	2291HKR	*2291-1HKR	◆	2291-2HKR	4,94,172,234,236,280	Y	Y	N	N	Y	N	Y	1 7/8x32	3	10	SAP
NEW 00-02	350 LS-1	16723HKR	16723-1HKR	◆	16723-2HKR	Y-pipe for 2290HKR/2291HKR											
CHEVY II, NOVA																	
68-74	250	2602HKR	*2602-1HKR	◆	4		N	Y	Y	Y	Y	Y	Y	1 5/8x39	2 1/2	8	SAP
62-67	283-327	2122HKR	2122-1HKR	◆	4,23,62,185		N	Y	Y	N	Y	N	Y	1 5/8x33	3	10	SAP
62-67	265-400	2243HKR	2243-1HKR	◆	4,9,62,186,237,259		Y	Y	Y	N	Y	Y	Y	1 3/4x31	3	10	SAP
62-67	265-400	2214HKR	2214-1HKR	◆	4,21,62,84,138		N	N	N	Y	Y	Y	Y	1 3/4x26	3	15	SAP
68-74	265-400	2130HKR	2130-1HKR	◆	4,62,259,288		Y	Y	9	Y	Y	Y	Y	1 5/8x29	3	10	SAP
68-74	265-400	2131HKR	2131-1HKR	◆	4,62,288		Y	Y	N	Y	Y	Y	Y	1 3/4x30	3	10	SAP
68-74	265-400	2207HKR	2207-1HKR	◆	4,62		Y	Y	N	Y	Y	Y	Y	1 7/8x30	3 1/2	10	REC
75-79	265-400	2136HKR	2136-1HKR	◆	4,90,127		Y	Y	9	N	Y	Y	Y	1 5/8x30	3	10	SAP
75-79	265-400	2117HKR	2117-1HKR	◆	4,62,90		Y	Y	9	N	Y	Y	Y	1 3/4x32	3	10	SAP
75-79	265-400	2239HKR	2239-1HKR	◆	4,62		Y	Y	N	Y	Y	Y	Y	1 7/8x29	3 1/2	10	REC
68-72	396-502	2111HKR	2111-1HKR	◆	4,148,184		Y	Y	N	Y	Y	Y	Y	1 7/8x33	3 1/2	10	SAP
68-72	396-502	2205HKR	2205-1HKR	◆	4,148,184		Y	Y	Y	Y	Y	Y	Y	2x33	3 1/2	10	SAP
68-72	396-502	2285HKR	2285-1HKR	◆	4,148,184,265,289		N	Y	N	Y	Y	Y	Y	2 1/8x36	3 1/2	10	RD
CHEVELLE, MALIBU, EL CAMINO / CABALLERO, SPRINT, WAGONS																	
78-87	V6 90°	2143HKR	*2143-1HKR	◆	4,117		Y	Y	Y	Y	Y	Y	Y	1 1/2x30	2 1/2	8	SAP
64-77	265-400	2124HKR	2124-1HKR	◆	4,127		Y	Y	9	N	Y	Y	Y	1 5/8x31	3	10	REC
64-75	265-400	2116HKR	2116-1HKR	◆	4,62,211,221,237,261		Y	Y	N	Y	Y	Y	Y	1 3/4x31	3	10	SAP
78-87	265-400	2150HKR	2150-1HKR	◆	4,62,117,211		Y	Y	Y	N	N	Y	Y	1 5/8x30	3	10	SAP
78-87	265-400	2242HKR	2242-1HKR	◆	4,18,62,117,237		Y	Y	Y	N	N	Y	Y	1 3/4x30	3	10	SAP
64-74	396-502	2118HKR	2118-1HKR	◆	4,20,184,266		Y	Y	Y	Y	Y	Y	Y	1 3/4x30	3	10	SAP
64-67	396-502	2213HKR	2213-1HKR	◆	4,20,184,266		Y	Y	N	Y	Y	Y	Y	2x34	3 1/2	10	SAP
64-67	396-502	2220HKR	2220-1HKR	◆	4,18,20,184,266,289		Y	Y	N	Y	Y	Y	Y	2 1/8x34	3 1/2	10	RD
68-74	396-502	2250HKR	2250-1HKR	◆	4,148,184,266		Y	Y	Y	Y	Y	Y	Y	1 7/8x35	3 1/2	10	SAP
68-74	396-502	2217HKR	2217-1HKR	◆	4,148,184,266		Y	Y	Y	Y	Y	Y	Y	2x35	3 1/2	10	SAP
68-72	396-502	2265HKR	2265-1HKR	◆	4,18,148,184,266,289		Y	Y	N	Y	Y	Y	Y	2 1/8x36	3 1/2	10	RD
NEW 64-72	350 LS1	2289HKR	2289-1HKR	◆	4,283,284		Y	Y	Y	Y	Y	Y	Y	1 3/4x30	3	10	SAP
CORVETTE																	
55-62	265-400	2108HKR	2108-1HKR	◆	4,76,82,127,211		Y	Y	N	N	Y	N	Y	1 3/4x28	3	8	SAP
63-82	265-400	2134HKR	2134-1HKR	◆	4,62,76,117,185		Y	Y	9	N	Y	Y	Y	1 3/4x25	3	10	SAP
84-91	350	2149HKR		◆	4,15,48,90,94,212		Y	Y	N	N	Y	N	Y	1 3/4x26	3	8	SAP
84-96	350	2151HKR	2151-1HKR	◆	4,48,90,117,212,92		Y	Y	Y	N	Y	N	Y	1 3/4x26	3	8	SAP
86-91	350	16720HKR		◆	Y-Pipe for 2149HKR-2151HKR												
65-74	396-502	2123HKR	2123-1HKR	◆	4		Y	Y	Y	N	Y	N	Y	1 7/8x30	3	8	REC
65-74	396-502	2225HKR	2225-1HKR	◆	4,289		Y	Y	N	N	Y	N	Y	2 1/8x30	3 1/2	10	RD



SUPER COMPETITION FULL LENGTH CAR HEADERS

YEARS	ENGINES	Baked-On Black PAINT	Metallic Ceramic COATING	EMISSION CODE	FOOTNOTES	P/S	P/B	A/C	TRANSMISSION				TUBE SIZE		COLL	COLL	PORT SHAPE
									STANDARD/	FL	COL	FL	FL	IN	IN	LN	
MONTE CARLO																	
78-87	V6 90°	2143HKR	*2143-1HKR	◆ 4,117		Y	Y	Y	Y	Y	Y	Y	Y	1 1/2x30	2 1/2	8	SAP
70-77	265-400	2124HKR	2124-1HKR	◆ 4,127		Y	Y	9	N	N	Y	Y	Y	1 5/8x31	3	10	SAP
78-87	265-400	2242HKR	2242-1HKR	◆ 4,18,62,117,237		Y	Y	Y	N	N	Y	Y	Y	1 3/4x30	3	10	SAP
78-87	265-400	2150HKR	2150-1HKR	◆ 4,62,117,211		Y	Y	Y	N	N	Y	Y	Y	1 3/4x30	3	10	SAP
MONZA																	
75-79	265-400	2135HKR	2135-1HKR	◆ 4,62		Y	Y	Y	N	Y	N	Y	Y	1 1/2x31	2 1/2	8	SAP
PASSENGER, WAGONS - (FULL SIZE)																	
55-57	265-400	2110HKR	2110-1HKR	◆ 4,21,127,232		Y	Y	N	N	Y	N	Y	Y	1 3/4x30	3	10	SAP
55-57	265-400	2112HKR	2112-1HKR	◆ 4,21,47,62,111,260		Y	Y	N	N	Y	N	Y	Y	1 3/4x30	3	10	SAP
55-57	265-400	2102HKR	2102-1HKR	◆ 4,62,84,232		N	N	N	Y	Y	Y	Y	Y	1 3/4x32	3	10	SAP
58-64	265-400	2103HKR	2103-1HKR	◆ 4,62		Y	Y	9	Y	Y	Y	Y	Y	1 3/4x26	3	8	SAP
58-64	348-409	2171HKR	2171-1HKR	◆ 4		N	N	N	Y	Y	Y	Y	Y	1 7/8x36	3	8	SAP
65-70	265-400	2130HKR	2130-1HKR	◆ 4,62		Y	Y	9	Y	Y	Y	Y	Y	1 5/8x29	3	10	SAP
65-70	396-502	2202HKR	2202-1HKR	◆ 4,289		Y	Y	Y	Y	Y	Y	Y	Y	2 1/8x33	3 1/2	10	RD
71-87	265-400	2124HKR	2124-1HKR	◆ 4,117,127		Y	Y	9	N	N	Y	Y	Y	1 5/8x31	3	10	SAP
74	265-400	2116HKR	2116-1HKR	◆ 4,62,211,237		Y	Y	9	N	N	Y	Y	Y	1 3/4x31	3	10	SAP
71-74	396-502	2118HKR	2118-1HKR	◆ 4,184		Y	Y	Y	N	N	Y	Y	Y	1 3/4x30	3	10	SAP
CHRYSLER																	
LASER																	
84-88	2.2 L	5707HKR	*5707-1HKR	◆ 4		Y	Y	Y	N	Y	N	Y	Y	1 1/2x35	2 1/2	8	SAP
CORDOBA																	
75-83	318-360	5115HKR	5115-1HKR	◆ 4,10,201		Y	Y	Y	N	N	Y	Y	Y	1 3/4x34	3	10	SAP
DODGE																	
CHALLENGER, CHARGER, CORONET, WAGONS (B & E Bodies)																	
62-72	198-225	5602HKR	5602-1HKR	◆ 4		Y	Y	Y	Y	Y	Y	Y	Y	1 5/8x40	2 1/2	8	SAP
66-77	318-360	5115HKR	5115-1HKR	◆ 4,10,201		Y	Y	Y	Y	Y	Y	Y	Y	1 3/4x34	3	10	SAP
66-74	383-440	5111HKR	5111-1HKR	◆ 4,200		Y	Y	Y	Y	Y	Y	Y	Y	1 3/4x35	3	10	SAP
67-74	383-440	5101HKR	5101-1HKR	◆ 4,10,26,200		Y	Y	Y	Y	Y	Y	Y	Y	1 7/8x35	3	10	SAP
67-72	440	5209HKR	5209-1HKR	◆ 4,200		Y	Y	Y	Y	Y	Y	Y	Y	2x32	3 1/2	10	SAP
67-71	426 Hemi	5210HKR	5210-1HKR	◆ 4		Y	Y	Y	Y	Y	Y	Y	Y	2 1/8x30	3 1/2	12	SAP
NEW 68-74	5.7L HEMI	5020HKR	5020-1HKR	◆ 4,282		Y	Y	Y	Y	Y	Y	Y	Y	1 5/8x32	3	10	SAP
DART, DEMON, DIPLOMAT, SWINGER (A & F Bodies)																	
64-66	273-340	5208HKR	5208-1HKR	◆ 4,27		Y	Y	Y	N	N	Y	Y	Y	1 5/8x43	2 1/2	8	SAP
67-79	198-225	5602HKR	5602-1HKR	◆ 4,39		Y	N	Y	Y	Y	Y	Y	Y	1 5/8x40	2 1/2	8	SAP
67-79	318-360	5116HKR	5116-1HKR	◆ 4,10,201		Y	Y	Y	Y	Y	Y	Y	Y	1 5/8x35	3	10	SAP
70-72	318-360	5204HKR	5204-1HKR	◆ 4,10,201		N	Y	Y	Y	Y	Y	Y	Y	1 3/4x38	3	10	SAP
67-69	383-440	5205HKR	5205-1HKR	◆ 4,84,200		Y	Y	N	Y	Y	Y	Y	Y	1 7/8x40	3 1/2	10	SAP
67-69	383-440	5215HKR	5215-1HKR	◆ 4,84,200		Y	N	N	Y	Y	Y	Y	Y	2x43	3 1/2	9	SAP
MAGNUM XE, ST. REGIS																	
78-82	318-360	5115HKR	5115-1HKR	◆ 4,10,201		Y	Y	Y	N	N	Y	Y	Y	1 3/4x34	3	10	SAP
MONACO, POLARA, WAGONS (C Bodies)																	
78	318-360	5115HKR	5115-1HKR	◆ 4,10,201		Y	Y	Y	N	N	Y	Y	Y	1 3/4x34	3	10	SAP
68-77	383-440	5113HKR	5113-1HKR	◆ 4,10,200		Y	Y	Y	N	N	Y	Y	Y	1 3/4x35	3	10	SA
ARIES, CHARGER, DAYTONA (K Car)																	
81-88	2.2 L	5707HKR	*5707-1HKR	◆ 4,117		Y	Y	Y	N	Y	N	Y	Y	1 1/2x35	2 1/2	8	SAP

TIP: Breaking in an engine with ceramic coated headers WILL result in damage to the coating and will VOID all warranties. Ceramic coated headers require several heat cycles to fully cure before they will withstand extreme heat. Hooker recommends using cast iron exhaust manifolds or old headers to break in new engines to avoid coating damage. Please call Hooker tech service at 270-781-9741 for additional information regarding ceramic coated exhaust products.

Y=Yes N=No SAP=Same as Port RD=Round REC=Rectangle

Tech Line: 270-781-9741

Footnotes can be found on
Pages 66 - 68

STREET FORCE HEADERS
CAMARO/FIBERGLASS HEADERS & Y-PIPE
COMPETITION HEADERS
MUSTANG GT EXHAUST SYSTEM
SUPER COMPETITION HEADERS
RACE HEADERS
COMPETITION & SUPER COMP EXHAUST KITS
DIESEL EXHAUST SYSTEMS
CARTACK SYSTEMS
MUFFLERS
EXHAUST TIPS
COMPONENTS & ACCESSORIES
HEADER & COLLECTOR GASKETS
FOOTNOTES
PHOTO GALLERY
PART # TO PAGE INDEX
WARRANTY

STREET FORCE HEADERS
CAMARO/ FIREBIRD LS1 HEADERS & Y-PIPE
COMPETITION HEADERS
MUSTANG GT EXHAUST SYSTEM
SUPER COMPETITION HEADERS
RACE HEADERS
COMPETITION & SUPER COMP EXHAUST KITS
DIESEL EXHAUST SYSTEMS
CATBACK SYSTEMS
MUFFLERS
EXHAUST TIPS
COMPONENTS & ACCESSORIES
HEADER & COLLECTOR GASKETS
FOOTNOTES
PHOTO GALLERY
PART # TO PAGE INDEX
WARRANTY

SUPER COMPETITION

FORD/MERCURY, OLDSMOBILE & PLYMOUTH

SUPER COMPETITION FULL LENGTH CAR HEADERS

YEARS	ENGINES	Baked-On Black PAINT	Metallic Ceramic COATING	EMISSION CODE	FOOTNOTES	P/S	P/B	A/C	TRANSMISSION STANDARD/ AUTO				TUBE SIZE O.D. IN	COLL SIZE O.D. IN	COLL LN IN	PORT SHAPE
									COL	FL	COL	FL				
FORD / MERCURY																
FAIRLANE / METEOR																
62-65	260-289W	6134HKR	6134-1HKR	◆	44,49,204,213	Y	Y	Y	N	Y	Y	Y	1 5/8x33	3	5 1/2	REC
FALCON / COMET																
65-70	170-200	6601HKR	*6601-1HKR	◆	4,34	Y	Y	N	Y	Y	Y	Y	1 1/2x38	2 1/2	8	RD
FALCON, FAIRLANE (66 & up), TORINO, RANCHERO / COMET, CYCLONE, MONTEGO																
63-67	260-289W	6102HKR	6102-1HKR	◆	4,44,68,188	83	Y	N	N	Y	N	Y	1 5/8x31	3	10	SAP
68-73	302W	6102HKR	6102-1HKR	◆	4,32,44,68,188	83	Y	Y	N	N	Y	Y	1 5/8x31	3	10	SAP
66-69	351W	6116HKR	6116-1HKR	◆	4,49,290	83	Y	Y	Y	Y	Y	Y	1 5/8x29	3	8	SAP
70-71	351C	6210HKR	6210-1HKR	◆	4,29,44	N	Y	Y	Y	Y	Y	Y	1 7/8x36	3 1/2	10	SAP
72-74	351C	6203HKR	*6203-1HKR	◆	4,29,226	Y	Y	Y	Y	Y	Y	Y	1 7/8x32	3	10	SAP
73-79	351-400M	6125HKR	6125-1HKR	◆	4,33	Y	Y	Y	N	Y	Y	Y	1 3/4x31	3	10	SAP
75-79	351W	6124HKR	*6124-1HKR	◆	4,44,49	Y	Y	Y	Y	Y	Y	Y	1 5/8x30	3	8	SAP
66-69	390-428	6113HKR	6113-1HKR	◆	4,31,163	83	Y	Y	Y	Y	Y	Y	1 3/4x33	3	10	SAP
70-71	429	6115HKR	6115-1HKR	◆	4,31	Y	Y	Y	Y	Y	Y	Y	1 7/8x35	3 1/2	10	SAP
70-71	429 CJ	6201HKR	6201-1HKR	◆	4,30,31	N	Y	Y	Y	Y	Y	Y	2 1/8x37	3 1/2	10	SAP
72-75	429-460	6126HKR	6126-1HKR	◆	4	Y	Y	Y	N	N	Y	Y	1 7/8x31	3	10	SAP
LTD II, THUNDERBIRD																
75-79	351W	6124HKR	*6124-1HKR	◆	4,44,49	Y	Y	Y	Y	Y	Y	Y	1 5/8x30	3	8	SAP
77-79	351-400M	6125HKR	6125-1HKR	◆	4,33	Y	Y	Y	N	Y	Y	Y	1 3/4x31	3	10	SAP
MAVERICK / COMET																
70-72	170-200	6601HKR	*6601-1HKR	◆	4	Y	N	Y	Y	Y	Y	Y	1 1/2x38	2 1/2	8	RD
71-77	302W	6110HKR	*6110-1HKR	◆	4,44,68	83	N	Y	N	N	Y	Y	1 5/8x34	3	8	SAP
MUSTANG / COUGAR																
65-70	170-200	6601HKR	*6601-1HKR	◆	4	Y	Y	N	N	Y	N	Y	1 1/2x38	2 1/2	8	SAP
64-70	260-302W	6111HKR	6111-1HKR	◆	4,44,49	83	Y	Y	N	Y	N	Y	1 5/8x30	3	10	SAP
71-73	302W	6102HKR	*6102-1HKR	◆	4,44,68,188	Y	Y	N	N	N	Y	Y	1 5/8x31	3	10	SAP
67-70	Boss 302	6209HKR	6209-1HKR	◆	4,29,44	83	Y	Y	N	Y	N	N	1 7/8x36	3 1/2	10	SAP
67-70	351W	6116HKR	6116-1HKR	◆	4,49,290	83	Y	Y	N	Y	N	Y	1 5/8x29	3	8	SAP
71-73	351C	6119HKR	6119-1HKR	◆	4,33,44	Y	Y	Y	N	Y	N	Y	1 3/4x30	3	8	SAP
71-73	351C	6211HKR	6211-1HKR	◆	4,29,226	Y	Y	Y	N	Y	N	Y	2x34	3 1/2	10	SAP
67-70	390-428	6114HKR	6114-1HKR	◆	4,163,281	83	Y	Y	N	Y	N	Y	1 3/4x33	3	10	SAP
71-73	429	6115HKR	6115-1HKR	◆	4,31	Y	Y	Y	N	Y	N	Y	1 7/8x35	3 1/2	10	SAP
71-73	429CJ	6201HKR	6201-1HKR	◆	4,30,31	Y	Y	Y	N	Y	N	Y	2 1/8x37	3 1/2	10	SAP
MUSTANG, MUSTANG II																
75-78	302W	6120HKR	*6120-1HKR	◆	4,44,68	Y	Y	Y	N	Y	N	Y	1 1/2x28	2 1/2	8	SAP
79-93	255-302W	6222HKR	6222-1HKR	◆	4,44,49,69,92	Y	Y	Y	N	Y	N	Y	1 5/8x30	3	8	SAP
79-93	255-302W	6227HKR	6227-1HKR	◆	4,5,49,92,183,197	Y	Y	Y	N	Y	N	Y	1 3/4x30	3	8	SAP
86-93	255-302W	16764HKR			H-pipe for 6222HKR/6227HKR											
79-93	302W(TFS)	6225HKR	6225-1HKR	◆	4,44,67,117,187,197	Y	Y	Y	N	Y	N	Y	1 3/4x30	3	8	(16)

FOR HEADER COMPATIBILITY WITH AFTERMARKET HEADS SEE PAGE 25.

Y=Yes N=No SAP=Same as Port RD=Round REC=Rectangle

TIP: Breaking in an engine with ceramic coated headers WILL result in damage to the coating and will VOID all warranties. Ceramic coated headers require several heat cycles to fully cure before they will withstand extreme heat. Hooker recommends using cast iron exhaust manifolds or old headers to break in new engines to avoid coating damage. Please call Hooker tech service at 270-781-9741 for additional information regarding ceramic coated exhaust products.

For additional header applications see Engine Swap Section on pages 23-26

www.ilovemyhookerheaders.com



SUPER COMPETITION FULL LENGTH CAR HEADERS

YEARS	ENGINES	Baked-On Black PAINT	Metallic Ceramic COATING	VIBRATORY POLISHED STAINLESS	EMISSION CODE	FOOTNOTES	TRANSMISSION STANDARD/ AUTO				TUBE SIZE O.D. IN	COLL SIZE O.D. IN	COLL LN IN	PORT SHAPE			
							P/S	P/B	A/C	COL FL					COL FL	COL FL	
96-03	4.6L(2 valve)	6230HKR	*6230-1HKR	6230-2HKR	◆	4,233,236	Y	Y	Y	N	Y	N	Y	1 5/8x30	3	5	SAP
96-03	4.6L(4 valve)	6229HKR	*6229-1HKR	6229-2HKR	◆	4,236,254	Y	Y	Y	N	Y	N	Y	1 5/8x30	3	5	SAP
05-07	4.6L(3 valve)	6233HKR	*6233-1HKR		◆	277,279	Y	Y	Y	N	Y	N	Y	1 5/8x30	2 1/2	9	SAP
96-03	4.6L(2V)	16762HKR				aluminized cross-pipe w/o extension tubes for 6230HKR				2 1/2							
96-03	4.6L(4V)	16761HKR	16761-1HKR			aluminized cross-pipe w/o extension tubes for 6229HKR				2 1/2							
05-07	4.6L(3V)	16684HKR				stainless steel cross-pipe w/o extension tubes for 6233HKR				2 1/2							

PASSENGER, WAGONS - (FULL SIZE) Includes Galaxy/Monterey

61-64	352-427	6205HKR	6205-1HKR		◆	4,21,27				N	N	N	Y	Y	Y	Y	Y	17/8x36	3 1/2	10	SAP
65-69	390-428	6130HKR	6130-1HKR		◆	4,21,163				Y	Y	Y	N	N	Y	Y	Y	13/4x33	3	8	SAP

MERCURY (SEE FORD LISTING ALSO)

CAPRI																					
79-86	255-302W	6222HKR	6222-1HKR		◆	4,44,49,69,92	Y	Y	Y	N	Y	N	Y	Y	Y	Y	Y	15/8x30	3	8	SAP
79-86	302W(TFS)	6225HKR	6225-1HKR		◆	4,44,67,117,187,197	Y	Y	Y	N	Y	N	Y	Y	Y	Y	Y	13/4x30	3	8	(16)
79-86	302W	6227HKR	6227-1HKR		◆	4,5,49,92,183,197	Y	Y	Y	N	Y	N	Y	Y	Y	Y	Y	13/4x30	3	8	SAP

METEOR

62-63	260-289W	6134HKR	6134-1HKR		◆	4,44,49,204,213	Y	Y	Y	N	Y	Y	Y	Y	Y	Y	Y	15/8x33	3	5 1/2	REC
-------	----------	----------------	------------------	--	---	-----------------	---	---	---	---	---	---	---	---	---	---	---	---------	---	-------	-----

OLDSMOBILE

CUTLASS - (will not fit Cutlass Supreme)

68-77	350-403	3107HKR	3107-1HKR		◆	4,214	Y	Y	Y	N	Y	Y	Y	Y	Y	Y	Y	13/4x29	3	10	SAP
78-87	265-400CH	2150HKR	2150-1HKR		◆	4,62,117	Y	Y	Y	N	N	Y	Y	Y	Y	Y	Y	15/8x30	3	10	SAP
78-87	265-400CH	2242HKR	2242-1HKR		◆	4,18,62,117	Y	Y	Y	N	N	Y	Y	Y	Y	Y	Y	13/4x30	3	10	SAP
78-87	260-403	3108HKR	3108-1HKR		◆	4,214	Y	Y	Y	N	Y	Y	Y	Y	Y	Y	Y	13/4x26	3	5	SAP

442, CUTLASS, VISTA CRUISER WAGON

65-75	400-455	3101HKR	3101-1HKR		◆	4,214	Y	Y	Y	N	Y	Y	Y	Y	Y	Y	Y	13/4x32	3	10	SAP
68-75	400-455	3202HKR	3202-1HKR		◆	4,214	Y	Y	Y	N	N	Y	Y	Y	Y	Y	Y	17/8x36	3 1/2	10	SAP
68-72	400-455	3201HKR	3201-1HKR		◆	4,24,214	Y	Y	N	N	Y	Y	Y	Y	Y	Y	Y	2x32	3 1/2	10	SAP
78-87	260-403	3108HKR	3108-1HKR		◆	4,214	Y	Y	Y	N	Y	Y	Y	Y	Y	Y	Y	13/4x26	3	5	SAP

DELTA-88

71-75	400-455	3101HKR	3101-1HKR		◆	4	Y	Y	Y	N	N	Y	Y	Y	Y	Y	Y	13/4x32	3	10	SAP
71-75	400-455	3202HKR	3202-1HKR		◆	4	Y	Y	Y	N	N	N	Y	Y	Y	Y	Y	17/8x36	3 1/2	10	SAP

OMEGA

68-74	250	2602HKR	*2602-1HKR		◆	4	N	Y	Y	Y	Y	Y	Y	Y	Y	Y	Y	15/8x39	2 1/2	8	SAP
72-76	260-350	3104HKR	*3104-1HKR		◆	4	Y	Y	Y	N	N	Y	Y	Y	Y	Y	Y	13/4x30	3	10	SAP
75	Buick 350	1103HKR	*1103-1HKR		◆	4	Y	Y	Y	N	N	Y	Y	Y	Y	Y	Y	13/4x28	3	10	SAP

PLYMOUTH

BELVEDERE, GTX, ROAD RUNNER, SATELLITE, SEBRING, BARRACUDA (70-74), SPORT FURY (75-77), WAGON (B&E Bodies)

62-73	198-225	5602HKR	5602-1HKR		◆	4	Y	Y	Y	Y	Y	Y	Y	Y	Y	Y	Y	15/8x40	2 1/2	8	SAP
66-77	318-360	5115HKR	5115-1HKR		◆	4,10,201	Y	Y	Y	Y	Y	Y	Y	Y	Y	Y	Y	13/4x34	3	10	SAP
66-74	383-440	5111HKR	5111-1HKR		◆	4,200	Y	Y	Y	Y	Y	Y	Y	Y	Y	Y	Y	13/4x35	3	10	SAP
67-74	383-440	5101HKR	5101-1HKR		◆	4,10,26,200	Y	Y	Y	Y	Y	Y	Y	Y	Y	Y	Y	17/8x35	3	10	SAP
67-72	440	5209HKR	5209-1HKR		◆	4,200	Y	Y	Y	Y	Y	Y	Y	Y	Y	Y	Y	2x32	3 1/2	10	SAP
67-71	426 Hemi	5210HKR	5210-1HKR		◆	4	Y	Y	Y	Y	Y	Y	Y	Y	Y	Y	Y	2 1/8x30	3 1/2	10	SAP
NEW 68-74	5.7L HEMI	5020HKR	5020-1HKR		◆	4,282	Y	Y	Y	Y	Y	Y	Y	Y	Y	Y	Y	15/8x32	3	10	SAP

Tech Line: 270-781-9741

Footnotes can be found on
Pages 66 - 68

17

STREET FORCE
HEADERS

CAMARO/
FIBERD LST
HEADERS &
Y-PIPE

COMPETITION
HEADERS

MUSTANG GT
EXHAUST
SYSTEM

SUPER
COMPETITION
HEADERS

RACE
HEADERS

COMPETITION
& SUPER COMP
EXHAUST KITS

DIESEL EXHAUST
SYSTEMS

CARBURET
SYSTEMS

MUFFLERS

EXHAUST
TIPS

COMPONENTS
& ACCESSORIES

HEADER &
COLLECTOR
GASKETS

FOOTNOTES

PHOTO
GALLERY

PART #
TO PAGE
INDEX

WARRANTY

SUPER COMPETITION

PLYMOUTH, PONTIAC & 2WD TRUCK INTRODUCTION

SUPER COMPETITION FULL LENGTH CAR HEADERS

YEARS	ENGINES	Baked-On Black PAINT	Metallic Ceramic COATING	VIBRATORY POLISHED STAINLESS	EMISSION CODE	FOOTNOTES	TRANSMISSION STANDARD/ AUTO						TUBE SIZE O.D. IN	COLL SIZE O.D. IN	COLL LN IN	PORT SHAPE		
							P/S	P/B	A/C	COL	FL	COL					FL	
FURY I, II, III, 75 GRAN FURY, WAGON (C Bodies)																		
68-77	383-440	5113HKR	5113-1HKR	◆	4,10,200		Y	Y	Y	N	N	Y	Y	1 3/4x35	3	10	SAP	
BARRACUDA (64-69), DUSTER, VALIANT, VOLARE (A & F Bodies)																		
64-66	273-340	5208HKR	5208-1HKR	◆	4,27		Y	Y	Y	N	N	Y	Y	1 5/8x43	2 1/2	8	SAP	
67-79	198-225	5602HKR	5602-1HKR	◆	4,39		Y	N	Y	Y	Y	Y	Y	1 5/8x40	2 1/2	8	SAP	
67-79	318-360	5116HKR	5116-1HKR	◆	4,10,201		Y	Y	Y	Y	Y	Y	Y	1 5/8x35	3	10	SAP	
70-72	318-360	5204HKR	5204-1HKR	◆	4,10,201		N	Y	Y	Y	Y	Y	Y	1 3/4x38	3	10	SA	
67-69	383-440	5205HKR	5205-1HKR	◆	4,84,200		Y	Y	N	Y	Y	Y	Y	1 7/8x40	3 1/2	10	SAP	
67-69	383-440	5215HKR	5215-1HKR	◆	4,84,200		Y	N	N	N	Y	N	Y	2x43	3 1/2	9	SAP	
RELIANT, TURISMO (K Car)																		
81-88	2.2 L	5707HKR	*5707-1HKR	◆	4,117		Y	Y	Y	Y	Y	Y	Y	1 1/2x35	2 1/2	8	SAP	
PONTIAC																		
FIREBIRD, TRANS AM																		
70-74	250	2602HKR	*2602-1HKR	◆	4		N	Y	Y	N	Y	N	Y	1 5/8x39	2 1/2	8	SAP	
67-69	326-455	4107HKR	4107-1HKR	◆	4,126		Y	Y	Y	N	Y	N	Y	1 3/4x28	3	10	SAP	
77-81	301	4111HKR	*4111-1HKR	◆	4,117,126		Y	Y	Y	N	Y	N	Y	1 5/8x32	2 1/2	8	SAP	
70-81	326-455	4109HKR	4109-1HKR	◆	4,126		Y	Y	Y	N	Y	N	Y	1 3/4x28	3	10	SAP	
77-79	350-403OL	3107HKR	3107-1HKR	◆	4		Y	Y	Y	N	Y	N	Y	1 3/4x30	3	10	SAP	
70-74	400-455HO/SD	4202HKR	4202-1HKR	◆	4,151		Y	Y	Y	N	Y	N	Y	2x27	3 1/2	10	RD	
78-81	265-400CH	2136HKR	*2136-1HKR	◆	4,90,117,127		Y	Y	9	N	Y	N	Y	1 5/8x30	3	10	SAP	
78-81	265-400CH	2117HKR	2117-1HKR	◆	4,62,90,117		Y	Y	9	N	Y	N	Y	1 3/4x32	3	10	SAP	
78-81	265-400CH	2239HKR	2239-1HKR	◆	2,4,62,117		Y	Y	N	N	Y	N	Y	1 7/8x29	3 1/2	10	REC	
82-92	265-400CH	2210HKR	2210-1HKR	◆	4,62,117		Y	Y	Y	N	Y	N	Y	1 3/4x28	3	6 1/2	SAP	
82-92	265-400CH	2138HKR	2138-1HKR	◆	4,31,117,127		Y	Y	Y	N	Y	N	Y	1 1/2x28	2 1/2	7	SAP	
78-81	265-400CH	2117HKR	2117-1HKR	◆	4,62,90,117		Y	Y	9	N	Y	N	Y	1 3/4x32	3	10	SAP	
93-97	265-400	2231HKR	2231-1HKR	◆	2,90,117,238		Y	Y	Y	N	Y	N	Y	1 3/4x30	3	10	SAP	
NEW	98-99	350 LS-1	2290HKR	*2290-1HKR	2290-2HKR	◆	4,172,236,234,280	Y	Y	Y	N	Y	N	Y	1 7/8x32	3	10	SAP
NEW	00-02	350 LS-1	2291HKR	*2291-1HKR	2291-2HKR	◆	4,94,172,234,236,280Y	Y	Y	N	Y	N	Y	1 7/8x32	3	10	SAP	
NEW	00-02	350 LS-1	16723HKR	16723-1HKR	16723-2HKR		Y-pipe for 2290HKR/2291HKR											
GRAND PRIX, LE MANS, GRAND AM (78-81), GRAND LE MANS																		
78-87	265-400CH	2150HKR	*2150-1HKR	◆	4,62,117		Y	Y	Y	N	N	Y	Y	1 5/8x30	3	10	SAP	
78-87	265-400CH	2242HKR	*2242-1HKR	◆	4,18,62,117		Y	Y	Y	N	N	Y	Y	1 3/4x30	3	10	SAP	
GTO (up to '73), LE MANS																		
64-67	326-455	4106HKR	*4106-1HKR	◆	4,126		Y	Y	N	N	Y	Y	Y	1 3/4x30	3	10	SAP	
68-75	326-455	4108HKR	4108-1HKR	◆	4,126		Y	Y	Y	N	Y	Y	Y	1 3/4x28	3	10	SAP	
77	350-403OL	3107HKR	3107-1HKR	◆	4		Y	Y	Y	N	Y	Y	Y	1 3/4x30	3	10	SAP	
68-72	400-455HO/SD	4201HKR	4201-1HKR	◆	4,151		Y	Y	N	N	Y	Y	Y	2x28	3 1/2	10	RD	
TEMPEST, LE MANS																		
64-67	326-455	4106HKR	4106-1HKR	◆	4,126		Y	Y	N	N	Y	Y	Y	1 3/4x30	3	10	SAP	
VENTURA, PHOENIX, GTO (74)																		
70-74	250CH	2602HKR	*2602-1HKR	◆	4		N	Y	Y	N	Y	Y	Y	1 5/8x39	2 1/2	8	SAP	
72-74	350	4107HKR	4107-1HKR	◆	4,126		Y	Y	Y	N	Y	Y	Y	1 3/4x28	3	10	SAP	
75	Buick 350	1103HKR	*1103-1HKR	◆	4		Y	Y	Y	N	N	Y	Y	1 3/4x28	3	10	SAP	
77-79	265-400CH	2136HKR	*2136-1HKR	◆	4,127		Y	Y	9	N	Y	Y	Y	1 5/8x30	3	10	SAP	
77-79	265-400CH	2117HKR	2117-1HKR	◆	4,62,184		Y	Y	9	N	Y	Y	Y	1 3/4x31	3	10	SAP	
77-79	265-400CH	2239HKR	2239-1HKR	◆	4,62		Y	Y	N	N	Y	Y	Y	1 7/8x29	3 1/2	10	REC	

For additional header applications see Engine Swap Section on pages 23-26

www.ilovemyhookerheaders.com

- STREET FORCE HEADERS
- CAMARO/ FIREBIRD LS1 HEADERS & Y-PIPE
- COMPETITION HEADERS
- MUSTANG GT EXHAUST SYSTEM
- SUPER COMPETITION HEADERS
- RACE HEADERS
- COMPETITION & SUPER COMP EXHAUST KITS
- DIESEL EXHAUST SYSTEMS
- CATBACK SYSTEMS
- MUFFLERS
- EXHAUST TIPS
- COMPONENTS & ACCESSORIES
- HEADER & COLLECTOR GASKETS
- FOOTNOTES
- PHOTO GALLERY
- PART # TO PAGE INDEX
- WARRANTY



SUPER COMPETITION FULL LENGTH 3/4" TRUCK HEADERS

TURN YOUR TRUCK OR SUV INTO A REAL "GROUND POUNDER"!

Hooker has long been known for its dominance of the drag racing circuit, but did you know that Hooker can help the off-road enthusiast scorch the deserts, mountains and swamps of the world? Hooker Headers use long tube lengths and long transition collectors to produce monstrous low-mid range torque without sacrificing top end horsepower. Each Hooker header is designed to provide the finest fit and most durable construction available on the market today.

Hooker offers a complete line of full length and emission compatible headers for the off-road enthusiast to choose from. Whether it be a rock crawling Jeep or a 1000 mile desert racer, Hooker can bring your performance expectations to a new level.



#2065HKR

TIP: Breaking in an engine with ceramic coated headers WILL result in damage to the coating and will VOID all warranties. Ceramic coated headers require several heat cycles to fully cure before they will withstand extreme heat. Hooker recommends using cast iron exhaust manifolds or old headers to break in new engines to avoid coating damage. Please call Hooker tech service at 270-781-9741 for additional information regarding ceramic coated exhaust products.

Y=Yes N=No SAP=Same as Port RD=Round REC=Rectangle

Tech Line: 270-781-9741

Footnotes can be found on Pages 66 - 68

STREET FORCE HEADERS
CAMARO/FIBERD LSI HEADERS & Y-PIPE
COMPETITION HEADERS
MUSTANG GT EXHAUST SYSTEM
SUPER COMPETITION HEADERS
RACE HEADERS
COMPETITION & SUPER COMP EXHAUST KITS
DIESEL EXHAUST SYSTEMS
CATBACK SYSTEMS
MUFFLERS
EXHAUST TIPS
COMPONENTS & ACCESSORIES
HEADER & COLLECTOR GASKETS
FOOTNOTES
PHOTO GALLERY
PART # TO PAGE INDEX
WARRANTY

SUPER COMPETITION

2WD CHEVY/GMC, DODGE/PLYMOUTH, FORD
& 4WD AMC/JEEP & CHEVROLET/GMC

SUPER COMPETITION FULL LENGTH TRUCK HEADERS - 2WD

YEARS	ENGINES	Baked-On Black PAINT	Metallic Ceramic COATING	EMISSION CODE	FOOTNOTES	P/S	P/B	A/C	TRANSMISSION			TUBE SIZE O.D. IN	COLL SIZE O.D. IN	COLL LN IN	PORT SHAPE
									STANDARD/	AUTO	COL FL				

CHEVROLET / GMC

EL CAMINO, CABALLERO, SPRINT

64-77	265-400	2124HKR	2124-1HKR	◆	4,127		Y	Y	9	N	Y	Y	Y	1 5/8x31	3	10	SAP
64-75	265-400	2116HKR	2116-1HKR	◆	4,62,211		Y	Y	N	N	Y	Y	Y	1 3/4x31	3	10	SAP
78-87	265-400	2150HKR	2150-1HKR	◆	4,62,117		Y	Y	Y	N	N	Y	Y	1 5/8x30	3	10	SAP
78-87	265-400	2242HKR	2242-1HKR	◆	4,18,62,117		Y	Y	Y	N	N	Y	Y	1 3/4x30	3	10	SAP
64-74	396-502	2118HKR	2118-1HKR	◆	4,20,184		Y	Y	Y	N	Y	Y	Y	1 3/4x30	3	10	SAP
64-67	396-502	2213HKR	2213-1HKR	◆	4,20,184		Y	Y	N	N	Y	Y	Y	2x34	3 1/2	10	SAP
68-74	396-502	2250HKR	2250-1HKR	◆	4,184		Y	Y	Y	N	Y	Y	Y	1 7/8x35	3 1/2	10	SAP
68-74	396-502	2217HKR	2217-1HKR	◆	4,184		Y	Y	Y	N	Y	Y	Y	2x35	3 1/2	10	SAP

BLAZER/YUKON, JIMMY, SUBURBAN, 1-TON CREW CAB

69-91	265-400	2808HKR	2808-1HKR	◆	4,117,127		Y	Y	9	Y	Y	Y	Y	1 5/8x30	2 1/2	8	SAP
68-91	265-400	2840HKR	2840-1HKR	◆	4,62,117		Y	Y	Y	Y	Y	Y	Y	1 3/4x28	3	10	SAP
92-98	265-400	2806HKR	2806-1HKR	◆	4,62,92		Y	Y	Y	N	N	Y	Y	1 3/4x32	3	8	SAP
69-91	396-502	2826HKR	2826-1HKR	◆	4,117		Y	Y	Y	Y	Y	Y	Y	1 7/8x35	3	10	SAP
68-91	396-502	2841HKR	2841-1HKR	◆	4		Y	Y	Y	Y	Y	Y	N	2x35	3 1/2	10	SAP
92-98	396-502	2847HKR	2847-1HKR	◆	4,89,92		Y	Y	Y	N	Y	Y	Y	2x32	3 1/2	10	SAP
92-95	305-350	2065HKR	*2065-1HKR	◆	205,206,207,215		Y	Y	Y	N	N	Y	Y	1 5/8	3	3	SAP

1/2, 3/4, 1-TON TRUCK

55-59	265-400	2819HKR	2819-1HKR	◆	4,62		N	N	N	Y	Y	Y	Y	1 5/8x32	3	8	SAP
63-67	265-400	2801HKR	2801-1HKR	◆	4,62		Y	Y	9	Y	Y	Y	Y	1 5/8x30	2 1/2	8	SAP
68-87	265-400	2808HKR	2808-1HKR	◆	4,117,127		Y	Y	9	Y	Y	Y	Y	1 5/8x30	2 1/2	8	SAP
68-87	265-400	2840HKR	2840-1HKR	◆	4,62,117		Y	Y	9	Y	Y	Y	Y	1 3/8x28	3	10	SAP
68-87	396-402	2826HKR	2826-1HKR	◆	4,117		Y	Y	Y	Y	Y	Y	Y	1 7/8x35	3	10	SAP
68-87	396-402	2841HKR	2841-1HKR	◆	4		Y	Y	Y	Y	Y	Y	N	2x35	3 1/2	10	SAP

1500, 2500, 3500 TRUCK

92-98	396-502	2847HKR	2847-1HKR	◆	4,89,92		Y	Y	Y	N	N	Y	Y	2x32	3 1/2	10	SAP
NEW 99-05	4.8/5.3/6.0	2850HKR	2850-1HKR	◆	5,222		Y	Y	Y	Y	Y	Y	Y	1 5/8	3	6	SAP
NEW 99-05	4.8/5.3/6.0	2851HKR	2851-1HKR	◆	5,222		Y	Y	Y	Y	Y	Y	Y	1 3/4	3	6	SAP
88-98	265-400	2806HKR	2806-1HKR	◆	4,62,90,92		Y	Y	Y	N	N	Y	Y	1 3/4x32	3	8	SAP
99-05	4.8/5.3/6.0	16785HKR			Y-pipe for 2850HKR & 2850-1HKR												
99-05	4.8/5.3/6.0	16786HKR			Y-pipe for 2851HKR & 2851-1HKR												

S-10, S-10 BLAZER, S-15, S-15 JIMMY

88-93	V6 4.3L	2842HKR	*2842-1HKR	◆	4		Y	Y	Y	Y	Y	Y	Y	1 5/8x26	2 1/2	5 1/2	SAP
-------	---------	---------	------------	---	---	--	---	---	---	---	---	---	---	----------	-------	-------	-----

For additional header applications see Engine Swap Section on pages 23-26

www.ilovemyhookerheaders.com



SUPER COMPETITION FULL LENGTH TRUCK HEADERS - 2WD

YEARS	ENGINES	Baked-On Black PAINT	Metallic Ceramic COATING	EMISSION CODE	FOOTNOTES	TRANSMISSION STANDARD/ AUTO						TUBE SIZE O.D. IN	COLL SIZE O.D. IN	COLL LN IN	PORT SHAPE	
						P/S	P/B	A/C	COL	FL	COL					FL
DODGE / PLYMOUTH																
DAKOTA																
87-91	318-360	5803HKR	5803-1HKR	◆	4,10,117,201	Y	Y	Y	N	N	Y	Y	1 5/8x33	3	10	SAP
RAMPAGE																
82-84	2.2L	5707HKR	*5707-1HKR	◆	4,117	Y	Y	Y	N	Y	N	Y	1 1/2x35	2 1/2	8	SAP
FORD																
RANGER																
83-91	2300cc	6837HKR		◆	4,117	Y	Y	Y	N	Y	Y	Y	1 1/2x34	2 1/2	8	SAP
F-100, F-150, F-250, F-350																
65-93	240-300	6823HKR	*6823-1HKR	◆	4,42,117	Y	Y	Y	Y	Y	Y	Y	1 5/8x36	2 1/2	6	SAP
80-95	255-302W	6829HKR	6829-1HKR	◆	4,49,117	Y	Y	Y	N	Y	Y	Y	1 1/2x34	2 1/2	6	SAP
80-95	351W	6838HKR	6838-1HKR	◆	4,49,117	Y	Y	Y	Y	Y	N	Y	1 1/2x34	2 1/2	6	SAP
80-85	351-400M	6827HKR		◆	4,117	Y	Y	Y	Y	Y	N	Y	1 3/4x33	2 1/2	8	SAP
65-76	352-390	6809HKR	6809-1HKR	◆	4	Y	Y	Y	Y	Y	Y	Y	1 3/4x26	2 1/2	10	SAP
73-79	460	6811HKR	6811-1HKR	◆	4	Y	Y	Y	N	N	Y	Y	1 7/8x37	3	8	SAP
F-250, F-350																
88-95	460	6842HKR	6842-1HKR	◆	4,35,113	Y	Y	Y	N	Y	Y	N	1 7/8x30	3	8	SAP

SUPER COMPETITION FULL LENGTH TRUCK HEADERS - 4WD

AMC / JEEP																
JEEP CJ5, CJ6, CJ7																
72-80	304-401	9820HKR	*9820-1HKR	◆	2,4,84,123,141	Y	Y	N	Y	Y	Y	Y	1 3/4x29	3	8	SAP
72-80	304-401	9829HKR	*9829-1HKR	◆	4,123	Y	Y	Y	N	Y	Y	N	1 3/4x27	3	6 1/2	SAP
72-86	265-400CH	9825HKR	9825-1HKR	◆	4,62,84,137,141	Y	N	N	Y	Y	Y	Y	1 3/4x31	3	10	SAP
JEEP WRANGLER																
87-90	258	9828HKR	*9828-1HKR	◆	14,40,73,90,117	Y	Y	N	N	Y	N	N	1 5/8x26	2 1/2	12	SAP
SCRAMBLER																
81	304	9820HKR	*9820-1HKR	◆	2,4,84,123,141	Y	Y	Y	Y	Y	N	Y	1 3/4x29	3	8	SAP
CHEVROLET / GMC																
BLAZER, CARRYALL / JIMMY, YUKON, SUBURBAN, 1-TON CREW CAB, TAHOE 2 DOOR																
69-91	265-400	2827HKR	2827-1HKR	◆	4,117,127	Y	Y	9	N	Y	Y	N	1 5/8x28	2 1/2	8	SAP
92-98	265-400	2806HKR	2806-1HKR	◆	4,62,90,92,278	Y	Y	Y	N	N	Y	N	1 3/4x32	3	8	SAP
83-91	396-502	2817HKR	2817-1HKR	◆	2,4,90,117,167	Y	Y	Y	N	Y	Y	N	1 7/8x31	3	10	SAP
92-95	396-502	2849HKR	2849-1HKR	◆	2,4,89,90,92	Y	Y	Y	N	N	Y	N	1 7/8x30	3	10	SAP

TIP: Breaking in an engine with ceramic coated headers WILL result in damage to the coating and will VOID all warranties. Ceramic coated headers require several heat cycles to fully cure before they will withstand extreme heat. Hooker recommends using cast iron exhaust manifolds or old headers to break in new engines to avoid coating damage. Please call Hooker tech service at 270-781-9741 for additional information regarding ceramic coated exhaust products.

Y=Yes N=No SAP=Same as Port RD=Round REC=Rectangle

Tech Line: 270-781-9741

Footnotes can be found on
Pages 66 - 68

21

- STREET FORCE HEADERS
- CAMARO/FIBERGLASS HEADERS & Y-PIPE
- COMPETITION HEADERS
- MUSTANG GT EXHAUST SYSTEM
- SUPER COMPETITION HEADERS
- RACE HEADERS
- COMPETITION & SUPER COMP EXHAUST KITS
- DIESEL EXHAUST SYSTEMS
- CATBACK SYSTEMS
- MUFFLERS
- EXHAUST TIPS
- COMPONENTS & ACCESSORIES
- HEADER & COLLECTOR GASKETS
- FOOTNOTES
- PHOTO GALLERY
- PART # TO PAGE INDEX
- WARRANTY

SUPER COMPETITION

4WD CHEVROLET.GMC, FORD, INTERNATIONAL & ENGINE SWAP HEADERS



- STREET FORCE HEADERS
- CAMARO/FIREBIRD LS1 HEADERS & Y-PIPE
- COMPETITION HEADERS
- MUSTANG GT EXHAUST SYSTEM
- SUPER COMPETITION HEADERS
- RACE HEADERS
- COMPETITION & SUPER COMP EXHAUST KITS
- DIESEL EXHAUST SYSTEMS
- CATBACK SYSTEMS
- MUFFLERS
- EXHAUST TIPS
- COMPONENTS & ACCESSORIES
- HEADER & COLLECTOR GASKETS
- FOOTNOTES
- PHOTO GALLERY
- PART # TO PAGE INDEX
- WARRANTY

SUPER COMPETITION FULL LENGTH TRUCK HEADERS - 4WD

YEARS	ENGINES	Baked-On Black PAINT	Metallic Ceramic COATING	EMISSION CODE	FOOTNOTES	P/S	P/B	A/C	TRANSMISSION				TUBE SIZE O.D. IN	COLL SIZE O.D. IN	COLL LN IN	PORT SHAPE
									STANDARD/	AUTO	COL	FL				

CHEVROLET / GMC

1/2, 3/4, 1-TON TRUCK

67-87	265-400	2827HKR	2827-1HKR	◆	4,117,127		Y	Y	9	N	Y	Y	N	1 5/8x28	2 1/2	8	SAP
83-87	396-502	2817HKR	2817-1HKR	◆	4,90,117,167		Y	Y	Y	N	Y	Y	N	1 7/8x31	3	10	SAP

1500, 2500, 3500 TRUCK

88-98	265-400	2806HKR	2806-1HKR	◆	4,62,90,92,278		Y	Y	Y	N	N	Y	N	1 3/4x32	3	8	SAP
88-93	396-502	2849HKR	2849-1HKR	◆	4,89,90,92		Y	Y	Y	N	N	Y	N	1 7/8x30	3	10	SAP

FORD

BRONCO

65-93	4.9L 6 CYL	6823HKR	*6823-1HKR	◆	4,117		Y	Y	Y	Y	Y	Y	Y	1 5/8x36	2 1/2	6	SAP
66-77	302W	9814HKR		◆	49,84,141		Y	Y	Y	Y	Y	Y	Y	1 5/8x37	3	10	SAP
80-93	302W	6829HKR	6829-1HKR	◆	4,49,117		Y	Y	Y	N	Y	Y	Y	1 1/2x34	2 1/2	6	SAP
80-93	351W	6838HKR	6838-1HKR	◆	4,49,117		Y	Y	Y	Y	Y	Y	Y	1 1/2x34	2 1/2	6	SAP
80-85	351-400M	6827HKR	*6827-1HKR	◆	4,117		Y	Y	Y	Y	Y	Y	Y	1 3/4x33	2 1/2	8	SAP

BRONCO II, RANGER

83-93	4 CYL	6837HKR		◆	4,117		Y	Y	Y	N	Y	N	Y	1 1/2x34	2 1/2	8	SAP
-------	-------	---------	--	---	-------	--	---	---	---	---	---	---	---	----------	-------	---	-----

F-100, F-150

65-93	4.9L 6 CYL	6823HKR	*6823-1HKR	◆	4,117		Y	Y	Y	Y	Y	Y	Y	1 5/8x36	2 1/2	6	SAP
86-96	302 EFI	6050HKR	*6050-1HKR	◆	4,49,90,189		Y	Y	Y	Y	Y	Y	Y	1 5/8x14	3	3	SAP
80-93	302W	6829HKR	6829-1HKR	◆	4,117		Y	Y	Y	N	Y	Y	Y	1 1/2x34	2 1/2	6	SAP
88-96	351W	6843HKR	6843-1HKR	◆	90,113,168,218		Y	Y	Y	N	Y	Y	N	1 5/8x17	3	3	SAP
80-93	351W	6838HKR	6838-1HKR	◆	4,117		Y	Y	Y	Y	Y	Y	Y	1 1/2x34	2 1/2	6	SAP
80-85	351-400M	6827HKR	*6827-1HKR	◆	4,117		Y	Y	Y	Y	Y	Y	Y	1 3/4x33	2 1/2	8	SAP

F-250, F-350

65-91	4.9L 6 CYL	6823HKR	*6823-1HKR	◆	4,117		Y	Y	Y	Y	Y	Y	Y	1 5/8x36	2 1/2	6	SAP
86-96	302 EFI	6050HKR	*6050-1HKR	◆	49,89		Y	Y	Y	Y	Y	Y	Y	1 5/8x14	3	3	SAP
80-95	302W	6829HKR	6829-1HKR	◆	4,49,117		Y	Y	Y	N	Y	Y	Y	1 1/2x34	2 1/2	6	SAP
88-96	351W	6843HKR	6843-1HKR	◆	49,168,218		Y	Y	Y	N	Y	Y	N	1 5/8x14	3	3	SAP
80-95	351W	6838HKR	6838-1HKR	◆	4,49,117		Y	Y	Y	Y	Y	Y	Y	1 1/2x34	2 1/2	6	SAP
80-85	351-400M	6827HKR	*6827-1HKR	◆	4,90,117		Y	Y	Y	Y	Y	Y	Y	1 3/4x33	2 1/2	8	SAP
67-76	352-390	6808HKR	6808-1HKR	◆	4,163,224		Y	Y	Y	N	Y	Y	Y	1 3/4x31	2 1/2	10	SAP
88-95	460	6842HKR	6842-1HKR	◆	3,4,35,113		Y	Y	Y	N	Y	Y	N	1 7/8x30	3	8	SAP

INTERNATIONAL / TRAVELALL

SCOUT II

72-80	304-345	9826HKR	*9826-1HKR	◆	4,30		Y	Y	Y	N	Y	N	Y	1 5/8x32	2 1/2	8	REC
-------	---------	---------	------------	---	------	--	---	---	---	---	---	---	---	----------	-------	---	-----

Y=Yes N=No SAP=Same as Port RD=Round REC=Rectangle

TIP: Breaking in an engine with ceramic coated headers WILL result in damage to the coating and will VOID all warranties. Ceramic coated headers require several heat cycles to fully cure before they will withstand extreme heat. Hooker recommends using cast iron exhaust manifolds or old headers to break in new engines to avoid coating damage. Please call Hooker tech service at 270-781-9741 for additional information regarding ceramic coated exhaust products.

For additional header applications see Engine Swap Section on pages 23-26



SUPER COMPETITION ENGINE SWAP HEADERS

Hooker has a complete line of engine swap headers, front frame mounts and transmission mounts for popular engine swaps. Available for Chevy, Chrysler & Ford small block and big block engines. Hooker swap headers and mounts are designed to provide an exact fit when used together. Hooker swap headers add the extra horsepower and torque the serious enthusiast demands. Hooker Headers are the best single improvement you can make.

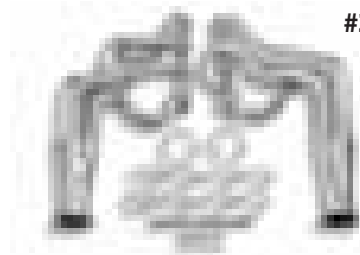

#2244-1HKR

YEARS	ENGINES	Baked-On Black PAINT	Metallic Ceramic COATING	VIBRATORY POLISHED STAINLESS	EMISSION CODE	FOOTNOTES	TRANSMISSION				TUBE SIZE O.D.	COLL SIZE O.D. IN	COLL LN IN	PORT SHAPE			
							STANDARD/	AUTO	COL	FL					COL	FL	
AMERICAN MOTORS																	
JEEP CJ5, CJ6, CJ7 - CHEVY V8																	
55-71	265-400	*9810HKR	*9810-1HKR	◆		52,62,84,141	N	N	N	Y	Y	N	N	1 3/4x30	3	10	SAP
72-86	265-400	9825HKR	9825-1HKR	◆		62,84,137,141	Y	N	N	Y	Y	Y	Y	1 3/4x32	3	10	SAP
BUICK																	
GRAND SPORT/SKYLARK																	
NEW 64-72	350 LS1	2289HKR	2289-1HKR	◆		4,283,284	Y	Y	Y	Y	Y	Y	Y	1 3/4x30	3	10	SAP
REGAL - CHEVY V8																	
78-87	396-502	2241HKR	2241-1HKR	◆		4,145	Y	Y	Y	N	N	Y	Y	2x30	3 1/2	10	SAP
SKYHAWK - CHEVY V8																	
75-79	265-400	2129HKR	2129-1HKR	◆		18,37,38,62,82	N	N	N	N	Y	N	Y	1 3/4x31	3	10	SAP
75-79	396-502	2240HKR	*2240-1HKR	◆		4,38,54,81	N	N	N	N	Y	N	Y	2 1/8x33	3 1/2	10	RD
CHEVROLET / GMC																	
BLAZER, JIMMY (4 WD)																	
69-91	396-502	2817HKR	2817-1HKR	◆		90,117,121,167	Y	Y	Y	Y	Y	Y	Y	1 7/8x31	3	10	SAP
S-10, S-10 BLAZER, S-15, S-15 JIMMY (2 WD)																	
82-93	265-400	2837HKR	2837-1HKR	◆		18,117,127,146	Y	Y	Y	N	N	Y	Y	1 5/8x34	2 1/2	8	SAP
S-10, S-10 BLAZER, S-15, S-15 JIMMY (4 WD)																	
82-93	265-400	2839HKR	2839-1HKR	◆		62,90,106,110,117	Y	Y	Y	N	N	Y	Y	1 5/8x33	3	8	SAP
73-91	396-502	2454HKR	2454-1HKR	◆		62,90,106,110,117	Y	Y	Y	N	N	Y	Y	1 5/8x33	3	8	SAP
1/2, 3/4 TON TRUCK (4WD)																	
67-87	396-502	2817HKR	2817-1HKR	◆		90,117,121,167	Y	Y	Y	Y	Y	Y	Y	1 7/8x31	3	10	SAP
CAMARO																	
NEW 67-69	350 LS1	2288HKR	2288-1HKR	◆		4,283,284	Y	Y	Y	Y	Y	Y	Y	1 3/4x30	3	10	SAP
73-81	396-502	2118HKR	2118-1HKR	◆		4,148,184,267	Y	Y	Y	N	Y	N	Y	1 3/4x30	3	10	SAP
73-81	396-502	2250HKR	2250-1HKR	◆		4,148,184,267	Y	Y	Y	N	Y	N	Y	1 7/8x35	3 1/2	10	SAP
73-81	396-502	2217HKR	2217-1HKR	◆		4,148,184,267	Y	Y	Y	N	Y	N	Y	2x35	3 1/2	10	SAP
73-81	396-502	2287HKR	2287-1HKR	◆		4,148,184,267,289	Y	Y	N	N	Y	N	Y	2 1/8x32	3 1/2	10	RD
82-92	396-502	2226HKR	2226-1HKR	◆		4,145,265	Y	Y	Y	N	Y	N	Y	1 7/8x30	3	16	SAP

Tech Line: 270-781-9741

Footnotes can be found on
Pages 66 - 68

23

- STREET FORCE HEADERS
- CAMARO/FIBERGLASS HEADERS & Y-PIPE
- COMPETITION HEADERS
- MUSTANG GT EXHAUST SYSTEM
- SUPER COMPETITION HEADERS
- RACE HEADERS
- COMPETITION & SUPER COMP EXHAUST KITS
- DIESEL EXHAUST SYSTEMS
- CARBURETOR SYSTEMS
- MUFFLERS
- EXHAUST TIPS
- COMPONENTS & ACCESSORIES
- HEADER & COLLECTOR GASKETS
- FOOTNOTES
- PHOTO GALLERY
- PART # TO PAGE INDEX
- WARRANTY

SUPER COMPETITION

CHEVROLET/GMC, DATSUN/NISSAN, DODGE & FORD/MERCURY ENGINE SWAP

SUPER COMPETITION ENGINE SWAP HEADERS

YEARS	ENGINES	Baked-On Black PAINT	Metallic Ceramic COATING	EMISSION CODE	FOOTNOTES	TRANSMISSION					TUBE SIZE O.D. IN	COLL SIZE O.D. IN	COLL LN IN	PORT SHAPE		
						P/S	P/B	A/C	COL	FL					COL	FL
CHEVROLET / GMC																
CHEVELLE, MALIBU, EL CAMINO																
NEW 64-72	350 LS1	2289HKR	2289-1HKR	◆	4,283,284	Y	Y	Y	Y	Y	Y	Y	1 3/4x30	3	10	SAP
75-77	396-502	2118HKR	2118-1HKR	◆	4,92,148,184,266	Y	Y	Y	Y	Y	Y	Y	1 3/4x30	3	10	SAP
75-77	396-502	2250HKR	2250-1HKR	◆	4,148,184,266	Y	Y	Y	Y	Y	Y	Y	1 7/8x35	3 1/2	10	SAP
75-77	396-502	2217HKR	2217-1HKR	◆	2,4,148,184,266	Y	Y	Y	Y	Y	Y	Y	2x35	3 1/2	10	SAP
78-87	396-502	2241HKR	2241-1HKR	◆	4,145,266	Y	Y	Y	N	N	Y	Y	2x30	3 1/2	10	SAP
CHEVY II, NOVA																
62-67	396-502	2280HKR	2280-1HKR	◆	4,84	N	N	N	N	Y	Y	Y	2x33	3 1/2	8	SAP
73-75	396-502	2111HKR	2111-1HKR	◆	4,148,184	Y	Y	N	N	Y	Y	Y	1 7/8x33	3 1/2	10	SAP
73-75	396-502	2205HKR	2205-1HKR	◆	4,148,184	Y	Y	Y	N	Y	Y	Y	2x33	3 1/2	10	SAP
73-75	396-502	2285HKR	2285-1HKR	◆	4,148,184,289	N	Y	N	N	Y	Y	Y	2 1/8x36	3 1/2	10	RD
PASSENGER, WAGONS																
55-57	396-502	2227HKR	2227-1HKR	◆	4,103,232,289	N	N	N	N	Y	Y	Y	2 1/8x33	3 1/2	10	RD
55-57	396-502	2244HKR	*2244-1HKR	◆	4,111,229,232	N	N	N	N	Y	Y	Y	1 7/8x33	3 1/2	10	SAP
58-64	396-502	2201HKR	2201-1HKR	◆	4,18,289	Y	Y	N	N	Y	N	Y	2 1/8x35	3 1/2	10	RD
CORVETTE																
63-82	396-502	2123HKR	2123-1HKR	◆	4,184	Y	Y	Y	N	Y	N	Y	1 7/8x30	3	8	SAP
63-82	396-502	2225HKR	2225-1HKR	◆	4,184,289	Y	Y	N	N	Y	N	Y	2 1/8x30	3 1/2	10	RD
LUV - CHEVY V8 (58 AND LATER SMALL BLOCK) (2WD)																
72-80	265-400	2140HKR	*2140-1HKR	◆	14,30,96,127	N	N	N	N	Y	N	Y	1 3/4x34	3	10	SAP
MONTE CARLO, EL CAMINO, MALIBU, CABALLERO																
78-87	396-502	2241HKR	2241-1HKR	◆	4,145	Y	Y	Y	N	N	Y	Y	2x30	3 1/2	10	SAP
MONZA, VEGA - CHEVY V8																
71-80	265-400	2129HKR	2129-1HKR	◆	18,37,38,62,82	N	N	N	N	Y	N	Y	1 3/4x31	3	10	SAP
71-80	396-502	2240HKR	2240-1HKR	◆	4,38,54,81,289	N	N	N	N	Y	N	Y	2 1/8x33	3 1/2	10	RD
DATSUN / NISSAN																
240, 260, 280Z - Chevy V8																
70-78	265-400	2147HKR	*2147-1HKR	◆	4,118,119,127	N	Y	Y	N	Y	N	Y	1 5/8x30	2 1/2	7	SAP
DODGE																
CHARGER, CHALLENGER, CORONET, R/T, SUPER BEE (B&E Bodies)																
NEW 68-74	5.7L HEMI	5020HKR	5020-1HKR	◆	4,282	Y	Y	Y	Y	Y	Y	Y	1 5/8x32	3	10	SAP
ASPEN, DART, DEMON, DIPLOMAT, SWINGER (A Bodies)																
70-75	383-440	5205HKR	5205-1HKR	◆	4,84,200	Y	Y	N	N	Y	Y	Y	1 7/8x40	3 1/2	10	SAP
70-75	383-440	5215HKR	5215-1HKR	◆	4,84,200	Y	N	N	N	Y	Y	Y	2x43	3 1/2	9	SAP
FORD / MERCURY																
BRONCO, F-150 (77 1/2-79) (4WD)																
78-79	429-460	6841HKR	6841-1HKR	◆	4,132,140	Y	Y	Y	Y	Y	Y	Y	1 7/8x30	3	8	SAP

- STREET FORCE HEADERS
- CAMARO/ FIREBIRD LS1 HEADERS & Y-PIPE
- COMPETITION HEADERS
- MUSTANG GT EXHAUST SYSTEM
- SUPER COMPETITION HEADERS
- RACE HEADERS
- COMPETITION & SUPER COMP EXHAUST KITS
- DIESEL EXHAUST SYSTEMS
- CATBACK SYSTEMS
- MUFFLERS
- EXHAUST TIPS
- COMPONENTS & ACCESSORIES
- HEADER & COLLECTOR GASKETS
- FOOTNOTES
- PHOTO GALLERY
- PART # TO PAGE INDEX
- WARRANTY



SUPER COMPETITION ENGINE SWAP HEADERS

YEARS	ENGINES	Baked-On Black PAINT	Metallic Ceramic COATING	EMISSION CODE	FOOTNOTES	P/S	P/B	A/C	TRANSMISSION				TUBE SIZE O.D. IN	COLL SIZE O.D. IN	COLL LN IN	PORT SHAPE
									STANDARD/	FL	COL	FL				
CAPRI																
79-86	351W	6223HKR	6223-1HKR	◆	4,49,69,117	Y	Y	Y	N	Y	N	Y	1 3/4x30	3	8	(16)
79-86	351W(TFS)	6226HKR	*6226-1HKR	◆	44,67,117,197	Y	Y	Y	N	Y	N	Y	1 3/4x30	3	8	(16)
79-86	429-460	6224HKR	6224-1HKR	◆	4,59,117,165	Y	Y	Y	N	N	N	Y	2x31	3 1/2	10	SAP
79-86	351W	6228HKR	6228-1HKR	◆	4,69,205	Y	Y	Y	N	Y	N	Y	2x30	3 1/2	10	SAP
79-86	351W(TFSR)	6231HKR	6231-1HKR	◆	4,69	Y	Y	Y	N	Y	N	Y	2x30	3 1/2	10	RD
BRONCO II, RANGER (2WD)																
83-95	289-302	6802HKR	6802-1HKR	◆	44,61,63,68,166	Y	Y	Y	N	Y	Y	Y	1 5/8x28	3	10	SAP
PICKUP TRUCK F-250 (4WD)																
67-77	429-460	6824HKR	*6824-1HKR	◆	4,125,132,139	Y	Y	Y	Y	Y	Y	Y	1 7/8x34	3	10	SAP
77 1/2-79	429-460	6841HKR	6841-1HKR	◆	4,132,140,262	Y	Y	Y	Y	Y	Y	Y	1 7/8x30	3	8	SAP
80-87	429-460	6839HKR	*6839-1HKR	◆	4,117,134	Y	Y	Y	Y	Y	Y	N	1 7/8x30	3	9	SAP
MUSTANG / COUGAR																
67-69	Boss 302	6209HKR	6209-1HKR	◆	4,29,44,116	83	Y	Y	N	Y	N	N	1 7/8x36	3 1/2	10	SAP
67-69	351-C	6210HKR	6210-1HKR	◆	4,29,44,116	N	Y	Y	N	Y	N	Y	1 7/8x36	3 1/2	10	SAP
64-70	351W	6208HKR	6208-1HKR	◆	4,49,175,290	83	Y	Y	N	Y	N	Y	1 3/4x32	3	8	SAP
MUSTANG																
79-93	351W	6223HKR	6223-1HKR	◆	4,49,69,117	Y	Y	Y	N	Y	N	Y	1 3/4x30	3	8	(16)
79-93	351W(TFS)	6226HKR	*6226-1HKR	◆	4,44,67,117,197	Y	Y	Y	N	Y	N	Y	1 3/4x30	3	8	(16)
79-93	429-460	6224HKR	6224-1HKR	◆	4,59,117,165	Y	Y	Y	N	N	N	Y	2x31	3 1/2	10	SAP
94-95	351W	6133HKR	*6133-1HKR	◆	4,57,68,90	Y	Y	Y	N	Y	N	Y	1 5/8x12	3	3	SAP
79-93	351W	6228HKR	6228-1HKR	◆	4	Y	Y	Y	N	Y	N	Y	2x30	3 1/2	10	SAP
79-93	351W(TFSR)	6231HKR	6231-1HKR	◆	4	Y	Y	Y	N	Y	N	Y	2x30	3 1/2	10	SAP
PINTO - WINDSOR V8																
71-73	289-302	6160HKR	*6160-1HKR	◆	8,27,44,49,65	N	N	N	N	Y	N	Y	1 5/8x42	2 1/2	8	SAP
74-80	289-302	6161HKR	*6161-1HKR	◆	8,27,44,49	N	N	N	N	Y	N	Y	1 5/8x38	3	10	SAP
74-80	351W	6163HKR		◆	8,27,44,49	N	N	N	N	Y	N	Y	1 5/8x38	3	10	SAP

FORD HEADER COMPATIBILITY WITH AFTERMARKET HEADS CHART

Engine	Cylinder Head / Application(s)	Painted* Part No.	Tube Dia. (in)	Matching			Footnotes
				Tube Length (in)	Collector Size (IN)	Intermediate Pipe	
302W	Stock,Holley, GT40,Dart,Edelbrock and TFS Twisted Wedge Street Head	6222HKR	1 5/8	30	3	16764HKR	
302W	Stock,Holley, GT40,Dart,Edelbrock and TFS Twisted Wedge Street Head	6227HKR	1 3/4	30	3	N/A	
302W	TFS early (Double Flange Design) and TFS Twisted Wedge Race Head	6225HKR	1 3/4	30	3	N/A	
351W	Stock,Holley, GT40,Edelbrock and TFS Twisted Wedge Street Head (Double Flange Design)	6223HKR	1 3/4	30	3	N/A	
351W	TFS early (Double Flange Design) and TFS Twisted Wedge Race Head	6226HKR	1 3/4	30	3	N/A	
351W	Stock,Holley, GT40,Edelbrock and TFS Twisted Wedge Street Head (Double Flange Design)	6228HKR	2	30	3 1/2	N/A	
351W	Holley TFS street heat and TFS-R Race head	6231HKR	2	30	3 1/2	N/A	
429-460	Auto Trans Only, (Requires Use of Swap Kit #12678)	6224HKR	2	31	3	N/A	

Tech Line: 270-781-9741

Footnotes can be found on Pages 66 - 68

25

STREET FORCE HEADERS
CAMARO/FIBERD LSI HEADERS & Y-PIPE
COMPETITION HEADERS
MUSTANG GT EXHAUST SYSTEM
SUPER COMPETITION HEADERS
RACE HEADERS
COMPETITION & SUPER COMP EXHAUST KITS
DIESEL EXHAUST SYSTEMS
CARBACK SYSTEMS
MUFFLERS
EXHAUST TIPS
COMPONENTS & ACCESSORIES
HEADER & COLLECTOR GASKETS
FOOTNOTES
PHOTO GALLERY
PART # TO PAGE INDEX
WARRANTY

SUPER COMPETITION

OLDSMOBILE, PLYMOUTH, PONTIAC ENGINE SWAP
& ENGINE SWAP MOUNTS



- STREET FORCE HEADERS
- CAMARO/FIREBIRD LS1 HEADERS & Y-PIPE
- COMPETITION HEADERS
- MUSTANG GT EXHAUST SYSTEM
- SUPER COMPETITION HEADERS
- RACE HEADERS
- COMPETITION & SUPER COMP EXHAUST KITS
- DIESEL EXHAUST SYSTEMS
- CATBACK SYSTEMS
- MUFFLERS
- EXHAUST TIPS
- COMPONENTS & ACCESSORIES
- HEADER & COLLECTOR GASKETS
- FOOTNOTES
- PHOTO GALLERY
- PART # TO PAGE INDEX
- WARRANTY

SUPER COMPETITION ENGINE SWAP HEADERS

YEARS	ENGINES	Baked-On Black PAINT	Metallic Ceramic COATING	EMISSION CODE	FOOTNOTES	TRANSMISSION					TUBE SIZE O.D. IN	COLL SIZE O.D. IN	COLL LN IN	PORT SHAPE		
						P/S	P/B	A/C	COL	FL					COL	FL
OLDSMOBILE																
CUTLASS - 442																
NEW 64-72	350 LS1	2289HKR	2289-1HKR	◆	4,283,284	Y	Y	Y	Y	Y	Y	Y	13/4x30	3	10	SAP
CUTLASS - CHEVY V8																
78-87	396-502	2241HKR	2241-1HKR	◆	4,145	Y	Y	Y	N	N	Y	Y	2x30	3 1/2	10	SAP
CUTLASS - (will not fit with Cutlass Supreme)																
78-87	400-455	3203HKR	3203-1HKR	◆	4,18	Y	Y	Y	N	N	Y	Y	1 7/8x31	3 1/2	10	SAP
STARFIRE - CHEVY V8																
75-79	265-400	2129HKR	2129-1HKR	◆	18,37,38,62,82	N	N	N	N	Y	N	Y	13/4x31	3	10	SAP
75-79	396-502	2240HKR	*2240-1HKR	◆	38,54,81,289	N	N	N	N	Y	N	Y	2 1/8x33	3 1/2	10	RD
PLYMOUTH																
ROAD RUNNER, BARRACUDA, CUDA, GTX, SATELLITE, BELVEDERE																
NEW 68-74	5.7L HEMI	5020HKR	5020-1HKR	◆	4,282	Y	Y	Y	Y	Y	Y	Y	1 5/8x32	3	10	SAP
DUSTER, VALIANT, VOLARE (A Bodies)																
70-75	383-440	5205HKR	5205-1HKR	◆	4,84,200	Y	Y	N	Y	Y	Y	Y	1 7/8x40	3 1/2	10	SAP
70-75	383-440	5215HKR	5215-1HKR	◆	4,84,200	Y	N	N	N	Y	Y	Y	2x43	3 1/2	9	SAP
PONTIAC																
ASTRE, SUNBIRD - CHEVY V8																
75-79	265-400	2129HKR	2129-1HKR	◆	18,37,38,62,82	N	N	N	N	Y	N	Y	13/4x31	3	10	SAP
75-79	396-502	2240HKR	*2240-1HKR	◆	4,38,54,81	N	N	N	N	Y	N	Y	2 1/8x33	3 1/2	10	RD
GTO, LE MANS																
NEW 64-72	350 LS1	2289HKR	2288-1HKR	◆	4,283,284	Y	Y	Y	Y	Y	Y	Y	13/4x30	3	10	SAP
FIREBIRD, TRANS AM - CHEVY V8																
NEW 67-69	350 LS1	2288HKR	2288-1HKR	◆	4,283,284	Y	Y	Y	Y	Y	Y	Y	13/4x30	3	10	SAP
70-81	396-502	2118HKR	2118-1HKR	◆	4,148	Y	Y	Y	N	Y	N	Y	13/4x30	3	10	SAP
70-81	396-502	2250HKR	2250-1HKR	◆	4,148	Y	Y	Y	N	Y	N	Y	1 7/8x35	3 1/2	10	SAP
70-81	396-502	2217HKR	2217-1HKR	◆	4,148,184	Y	Y	Y	N	Y	N	Y	2x35	3 1/2	10	SAP
70-81	396-502	2287HKR	2287-1HKR	◆	4,148,184	Y	Y	N	N	Y	N	Y	2 1/8x32	3 1/2	10	RD
82-92	396-502	2226HKR	2226-1HKR	◆	4,145	Y	Y	Y	N	Y	N	Y	1 7/8x30	3	16	SAP
GRAND PRIX - Chevy V8																
78-87	396-502	2241HKR	2241-1HKR	◆	4,145	Y	Y	Y	N	N	Y	Y	2x30	3 1/2	10	SAP

Y=Yes N=No SAP=Same as Port RD=Round REC=Rectangle

TIP: Breaking in an engine with ceramic coated headers WILL result in damage to the coating and will VOID all warranties. Ceramic coated headers require several heat cycles to fully cure before they will withstand extreme heat. Hooker recommends using cast iron exhaust manifolds or old headers to break in new engines to avoid coating damage. Please call Hooker tech service at 270-781-9741 for additional information regarding ceramic coated exhaust products.



SUPER COMPETITION ENGINE SWAP MOUNTS

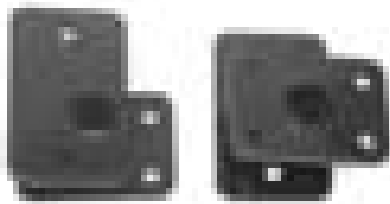

#12678HKR
79-93 Ford Mustang
Big Block V-8 Engine Swap Mount

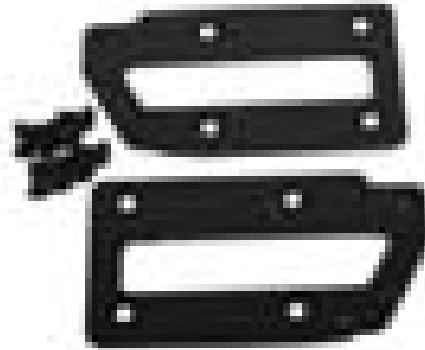

#12611HKR
LS Engine Swap Mount



#12677HKR
67-79 Ford F250 4WD 429-460
Engine Location Kit

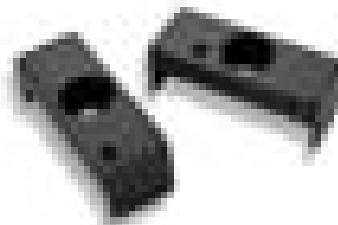

#12679HKR
83-94 Ranger/Bronco II 2WD
Ford Small Block Engine Swap Mount Kit



#12601HKR
71-74 Chevy Monza, Vega 265-400
Front Frame Mounts

For additional header applications see Engine Swap Section on pages 23-26

Tech Line: 270-781-9741

Footnotes can be found on
Pages 66 - 68

STREET FORCE HEADERS
CAMARO/FIBERD LS1 HEADERS & Y-PIPE
COMPETITION HEADERS
MUSTANG GT EXHAUST SYSTEM
SUPER COMPETITION HEADERS
RACE HEADERS
COMPETITION & SUPER COMP EXHAUST KITS
DIESEL EXHAUST SYSTEMS
CATBACK SYSTEMS
MUFFLERS
EXHAUST TIPS
COMPONENTS & ACCESSORIES
HEADER & COLLECTOR GASKETS
FOOTNOTES
PHOTO GALLERY
PART # TO PAGE INDEX
WARRANTY

SUPER COMPETITION

ENGINE SWAP MOUNTS & BLOCK HUGGER

SUPER COMPETITION ENGINE SWAP MOUNTS

Vehicle	Years	Front Frame Mounts	Manual, TH 350, or Powerglide Trans Mounts	Turbo 400 Trans Mounts
BUICK V-6 ENGINE SWAP				
Chevrolet				
Luv	72-80		12630HKR ⁽¹⁴⁾	
Oldsmobile				
Starfire	75-78		12635HKR ⁽⁹⁷⁾	
Pontiac				
Astre / Sunbird	75-78		12635HKR ⁽⁹⁷⁾	

CHEVY GEN III/IV (LS1/LS2/LS6/LS7)				
Chevrolet / Pontiac				
F-body	67-69	12611HKR	Use with standard SBC frame mounts	
Chevrolet/Pontiac / Oldsmobile/ Buick				
A- Body	64-72	12611HKR	Use with standard SBC frame mounts	

CHEVY V-8 (SMALL BLOCK) ENGINE SWAP				
Buick				
Skyhawk	75	12608HKR		
Chevrolet / GMC				
Luv (2WD)	72-80	12606HKR	12630HKR ⁽¹⁴⁾	
Monza, Vega	71-74	12601HKR	12601HKR	12601HKR
	75	12608HKR		
	76-80	12608HKR	12635HKR ⁽³⁸⁾	
S-10 / S-15 (2WD)	82-93	12609HKR ⁽²³⁹⁾		12649HKR
S-10 Blazer / S-15 Jimmy(4WD)	82-93	12610HKR ⁽²⁴⁰⁾		
Datsun / Nissan				
240, 260, 280Z	70-72	12651HKR		
	73-78	12651HKR		
Oldsmobile				
Starfire	75	12608HKR		
	76-79	12608HKR	12635HKR ⁽³⁸⁾	
Pontiac				
Astre, Sunbird	75	12608HKR		
	76-79	12608HKR	12635HKR ⁽³⁸⁾	

CHEVY V-8 (BIG BLOCK) ENGINE SWAP				
Buick				
Skyhawk	75	12603HKR		
	76-79	12603HKR	12635HKR ⁽³⁸⁾	
Chevrolet				
Monza, Vega	71-74	12603HKR		
	75	12603HKR	12635HKR ⁽³⁸⁾	
	76-80	12603HKR	12635HKR ⁽³⁸⁾	
Oldsmobile				
Starfire	75	12603HKR		
	76-79	12603HKR	12635HKR ⁽³⁸⁾	
Pontiac				
Astre, Sunbird	75	12603HKR		
	76-79	12603HKR	12635HKR ⁽³⁸⁾	

FORD V-8 (SMALL BLOCK) ENGINE SWAP				
Model	Years	Front Frame Mounts	Manual Trans Mounts	Borg-Warner C-4 Trans Mounts
Ranger, Bronco II (2WD)	83-94	12679HKR ⁽¹⁶⁶⁾		

FORD V-8 (BIG BLOCK) ENGINE SWAP				
Mustang	79-93	12678HKR ⁽¹⁶⁵⁾		
Pickup (4WD)	67-79	12677HKR ⁽¹³²⁾		

STREET FORCE HEADERS
CAMARO/ FIREBIRD LS1 HEADERS & Y-PIPE
COMPETITION HEADERS
MUSTANG GT EXHAUST SYSTEM
SUPER COMPETITION HEADERS
RACE HEADERS
COMPETITION & SUPER COMP EXHAUST KITS
DIESEL EXHAUST SYSTEMS
CATBACK SYSTEMS
MUFFLERS
EXHAUST TIPS
COMPONENTS & ACCESSORIES
HEADER & COLLECTOR GASKETS
FOOTNOTES
PHOTO GALLERY
PART # TO PAGE INDEX
WARRANTY



STREET FORCE
HEADERS

CAMARO/
FERRISD LS1
HEADERS &
Y-PIPE

COMPETITION
HEADERS

MUSTANG GT
EXHAUST
SYSTEM

SUPER
COMPETITION
HEADERS

RACE
HEADERS

COMPETITION
& SUPER COMP
EXHAUST KITS

DIESEL EXHAUST
SYSTEMS

CATBACK
SYSTEMS

MUFFLERS

EXHAUST
TIPS

COMPONENTS
& ACCESSORIES

HEADER &
COLLECTOR
GASKETS

FOOTNOTES

PHOTO
GALLERY

PART #
TO PAGE
INDEX

WARRANTY

SUPER COMPETITION BLOCK HUGGER HEADERS

Street Rod/Universal SUPER COMPETITION headers are great for custom car, truck, or street rod where a specific fit tuned SUPER COMPETITION header is not available. They work great for those tight-fit installations where frame rails are close to the engine block. Stock motor mounts can be used. Because the collector exits parallel with the oil pan rail, maximum ground clearance is allowed. These headers come complete with gaskets, header bolts and collector reducers. These headers come available in chrome, high-heat-resistant black paint or Hooker's Metallic Ceramic Thermal Barrier Coating.

#2101HKR
(CHROME)

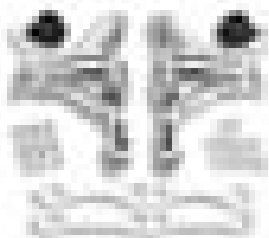

#2100HKR
(BLACK)

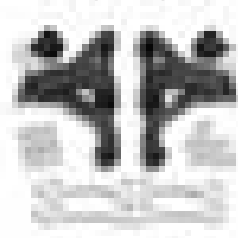

#2315HKR
(CHROME)

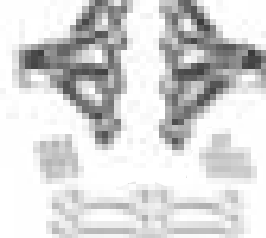

#2001HKR
(CERAMIC COATED)

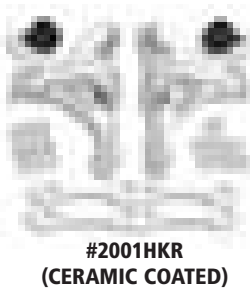

ENGINES	PART NO.	TUBE FINISH	EMISSION CODE	FOOTNOTES	TUBE SIZE & LENGTH O.D. IN	COLL SIZE O.D. IN	COLL LN IN	PORT SHAPE
CHEVROLET								
262-400	2100HKR	Black	◆	120,127,269	1 5/8	2 1/2	4	RD
262-400	2100-2HKR	Stainless	◆	120,127,269	1 5/8	2 1/2	4	RD
262-400	2101HKR	Chrome	◆	120,127,269	1 5/8	2 1/2	4	RD
262-400	2200HKR	Elite Stainless	◆	120,127,269	1 5/8	2 1/2	4	RD
262-400	2001HKR	Coated	◆	120,127,269	1 5/8	2 1/2	4	RD
350 LS1	2312HKR	Black	◆	268	1 5/8	2 1/2	6	SAP
350 LS1	2313HKR	Coated	◆	268	1 5/8	2 1/2	6	SAP
350 LS1	2314HKR	Stainless	◆	268	1 5/8	2 1/2	6	SAP
350 LS1	2315HKR	Chrome	◆	268	1 5/8	2 1/2	6	SAP
396-502	2180HKR	Black	◆	269	1 7/8	2 1/2	4	SAP
396-502	2180-2HKR	Stainless	◆	269	1 7/8	2 1/2	4	SAP
396-502	2181HKR	Chrome	◆	269	1 7/8	2 1/2	4	SAP
396-502	2183HKR	Coated	◆	269	1 7/8	2 1/2	4	SAP
FORD								
255-302W	6000HKR	Black	◆	49	1 5/8	2 1/2	4	SAP
255-302W	6001HKR	Chrome	◆	49	1 5/8	2 1/2	4	SAP
255-302W	6003HKR	Coated	◆	49	1 5/8	2 1/2	4	SAP

BLOCK HUGGER HEADERS FOR FAST BURN CHEVY (D-PORT) HEADS

FEATURES:

- Mandrel bent tuned-length primary tubes
- Tight-tuck tube design
- Collector exit is parallel with oil pan for maximum ground clearance
- Superior welds
- Increased horsepower and torque for the street
- Long lasting durability and exceptional appearance
- Available in chrome, high heat resistant black paint, polished stainless steel or Hooker's Metallic Ceramic Thermal Barrier Coating

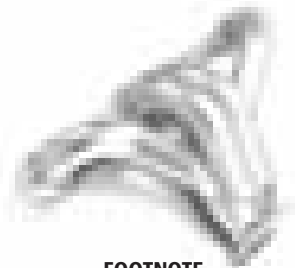
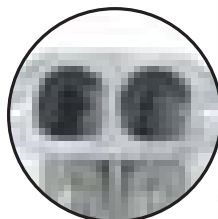

NOTE: Block Hugger headers will not fit any factory application with side engine mounts including 63-82 Corvette.

PART #	APPLICATION	FOOTNOTE
2300HKR	Chevy Fast Burn Heads, painted	269
2301HKR	Chevy Fast Burn Heads, ceramic	269
2302HKR	Chevy Fast Burn Heads, polished stainless	269
2303HKR	Chevy Fast Burn Heads, chrome	269

Tech Line: 270-781-9741

Footnotes can be found on Pages 66 - 68

SUPER COMPETITION

SIDEMOUNT & ROADSTER

SUPER COMPETITION SIDEMOUNT HEADERS

Super Competition Sidemount headers deliver the most aggressive style and performance for your early Corvette, Camaro, Nova or Firebird. Sidemount headers are built from lightweight 18 gauge tubing. Sidetubes slip directly to the collector for a leak free seal. Hooker sidemount headers and sidetubes come with 3 choices of coating; show quality chrome, high-heat-resistant black paint and Hooker's Metallic Ceramic Thermal Barrier Coating.

Replaceable Hooker mufflers are available separately in 2 different styles; glasspack and reverse flow. The glass pack style provides the highest performance with minimal backpressure and sound control. The reverse flow is designed for maximum sound control.



#2234HKR

YEARS	ENGINES	PART NO.	FINISH	SIDE TUBE REQUIRED	EMISSION CODE	FOOTNOTES	P/S	P/B	A/C	TRANSMISSION STANDARD/ AUTO & LENGTH				COLL SIZE O.D. IN	COLL LN IN	PORT SHAPE	
										COL	FL	COL	FL				
CAMARO																	
67-69	265-400	2238HKR	Chrome	76936HKR	◆	28,150	Y	Y	9	N	Y	N	Y	17/8x50	4	10	REC
CHEVY II, NOVA																	
68-74	265-400	2238HKR	Chrome	76936HKR	◆	28,150	Y	Y	9	N	Y	N	Y	17/8x50	4	10	REC
CORVETTE																	
63-82	265-400	2224HKR	Black	50735HKR	◆	2,28,76,127	Y	Y	9	N	Y	N	Y	17/8x46	4	10	REC
63-82	265-400	2224-1HKR	Coated	50735-1HKR	◆	28,76,127	Y	Y	9	N	Y	N	Y	17/8x46	4	10	REC
63-82	265-400	2224-3HKR	Stainless*	50735-3HKR	◆	28,76,127	Y	Y	9	N	Y	N	Y	17/8x46	4	10	REC
63-82	265-400	2234HKR	Chrome	65284HKR	◆	2,28,76,127	Y	Y	9	N	Y	N	Y	17/8x46	4	10	REC
65-74	396-502	2222HKR	Black	50735HKR	◆	19,184,265	Y	Y	Y	N	Y	N	Y	21/8x45	4	10	RD
65-74	396-502	2222-1HKR	Coated	50735-1HKR	◆	19,184,265	Y	Y	Y	N	Y	N	Y	21/8x45	4	10	RD
65-74	396-502	2233HKR	Chrome	65284HKR	◆	19,184,265	Y	Y	Y	N	Y	N	Y	21/8x45	4	10	RD
CORVETTE - ENGINE SWAPS																	
63-82	396-502	2222HKR	Black	50735HKR	◆	19,184,287	Y	Y	Y	N	Y	N	Y	21/8x45	4	10	RD
63-82	396-502	2222-1HKR	Coated	50735-1HKR	◆	19,184,287	Y	Y	Y	N	Y	N	Y	21/8x45	4	10	RD
63-82	396-502	2233HKR	Chrome	65284HKR	◆	19,184,287	Y	Y	Y	N	Y	N	Y	21/8x45	4	10	RD

* Hand Polished stainless

See page 50 for universal sidemount header kits and the NEW Maxflow™ sidepipe muffler

Y=Yes N=No SAP=Same as Port RD=Round REC=Rectangle

TIP: Breaking in an engine with ceramic coated headers WILL result in damage to the coating and will VOID all warranties. Ceramic coated headers require several heat cycles to fully cure before they will withstand extreme heat. Hooker recommends using cast iron exhaust manifolds or old headers to break in new engines to avoid coating damage. Please call Hooker tech service at 270-781-9741 for additional information regarding ceramic coated exhaust products.



SUPER COMPETITION ROADSTER HEADERS

Double flange for ease of installation. Each flange is 5/16" thick and flush ground for a better fit.

P/N# 10812HKR
Adapter flange gasket
P/N# 11891HKR
Adapter flange

Inner flange matched with port to allow relocation of bolt holes for maximum bolt head clearance. Simplifies installation.

Replaceable slip-in muffler available separately. Designed to run cooler by creating an air space between the outside skin of the muffler and inside of the sidepipe wall. Reduced running temperatures prolongs chrome life and reduces bluing. (see page 50)

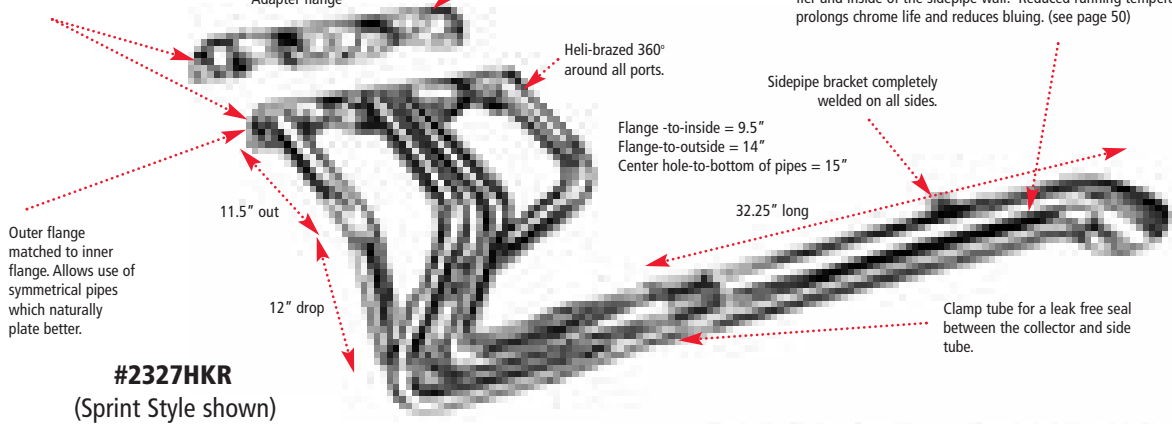

#2327HKR
(Sprint Style shown)

Show quality chrome. All Hooker roadster headers are polished before and after assembly to assure maximum chrome quality for full 360° around all pipes. Hooker's design gives special consideration to the electroplating process to reduce low current density areas which tend to result in poor chrome quality. Show quality chrome appearance is achieved with a full 45 minutes in the nickel tank.

#2326HKR



ENGINES	PART NO.	TUBE FINISH	SIDETUBE	EMISSION CODE	FOOTNOTES	TUBE SIZE & LENGTH O.D. IN	COLL SIZE O.D. IN	COLL LN IN	PORT SHAPE
STREET ROADSTER SIDEMOUNT STYLE HEADERS									
CLASSIC (23T Bucket)									
262-400 Chevy	2326HKR	Chrome	84393HKR	◆	62	1 3/4x30	4	10	(16)
SPRINT STYLE (23T Bucket)									
262-400 Chevy	2327HKR	Chrome	84394HKR	◆	62	1 7/8x36	4	10	(16)

NOTE: See page 52,53 for replaceable slip-in mufflers for these systems

For additional header applications see Engine Swap Section on pages 23-26

Tech Line: **270-781-9741**

Footnotes can be found on
Pages 66 - 68

- STREET FORCE HEADERS
- CAMARO/FIBERD LST HEADERS & Y-PIPE
- COMPETITION HEADERS
- MUSTANG GT EXHAUST SYSTEM
- SUPER COMPETITION HEADERS**
- RACE HEADERS
- COMPETITION & SUPER COMP EXHAUST KITS
- DIESEL EXHAUST SYSTEMS
- CATBACK SYSTEMS
- MUFFLERS
- EXHAUST TIPS
- COMPONENTS & ACCESSORIES
- HEADER & COLLECTOR GASKETS
- FOOTNOTES
- PHOTO GALLERY
- PART # TO PAGE INDEX
- WARRANTY

STREET FORCE HEADERS
CAMARO/FIREBIRD LS1 HEADERS & Y-PIPE
COMPETITION HEADERS
MUSTANG GT EXHAUST SYSTEM
SUPER COMPETITION HEADERS
RACE HEADERS
COMPETITION & SUPER COMP EXHAUST KITS
DIESEL EXHAUST SYSTEMS
CATBACK SYSTEMS
MUFFLERS
EXHAUST TIPS
COMPONENTS & ACCESSORIES
HEADER & COLLECTOR GASKETS
FOOTNOTES
PHOTO GALLERY
PART # TO PAGE INDEX
WARRANTY

SUPER COMPETITION

ADJUSTABLE RACE

SUPER COMPETITION ADJUSTABLE RACE HEADERS

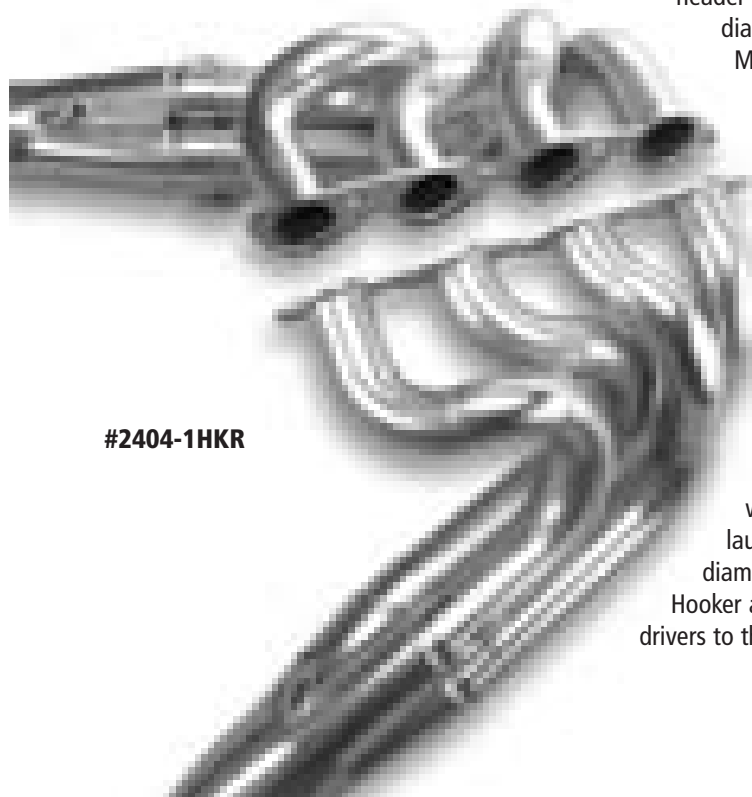

#2404-1HKR

Hooker Adjustable race headers allow you to change your header primary tube lengths, collector lengths and diameters and collector types (Classic 4 into 1, Merged and Split-Flow).

By altering the relationship between the primary length and collector diameter and length, it is possible to increase or decrease the torque and horsepower output at any specific R.P.M. level.

For a slick track, the header primaries or collectors can be shortened to decrease the low end torque for better traction. Larger diameter collectors will also reduce low end torque. On a good track with lots of bite, extending the primaries or collectors will pick up bottom end power for a harder launch and awesome e.t.'s. Smaller collector diameters will also increase low end torque.

Hooker adjustable headers have taken more Pro Stock drivers to the championship than any other brand.

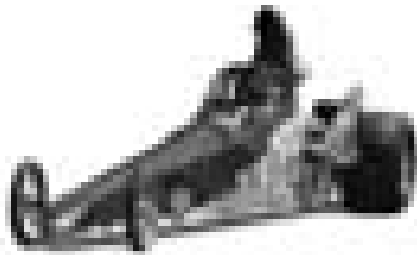

"I've been involved in the sport of drag racing for over three decades, and I've seen a lot of competitors, companies and products come and go. The Hooker Headers brand name has always been a sign of quality, consistent and powerful products. Throughout my racing career, and over the last decade sharing the track with my son, Bill and Dale, we've come to depend on Hooker and the entire Holley Performance brand for quality built-in components that fit right the first time. Hooker and Holley help give the Cummings Motorsports team a competitive advantage!"

Cummings Racing

14 Divisional Championships, 30 National Event wins,
3-Time IHRA National Championship winning team



SUPER COMPETITION ADJUSTABLE RACE HEADERS

YEARS	ENGINES	Baked-On Black PAINT	Metallic Ceramic COATING	EMISSION CODE	FOOTNOTES	P/S	P/B	A/C	TRANSMISSION				TUBE SIZE O.D. IN	COLL SIZE O.D. IN	COLL LN IN	PORT SHAPE
									STANDARD/	AUTO/	COL	FL				
CHEVROLET																
CAMARO																
67-69	265-400	2304HKR	2304-1HKR	◆	62,209	Y	Y	N	N	Y	N	Y	17/8x30-38	3 1/2	12"	16
67-69	265-400	2308HKR	2308-1HKR	◆	62	N	Y	N	N	Y	N	Y	2x30-38	3 1/2	12"	16
67-69	396-502	2386HKR	*2386-1HKR	◆		N	Y	N	N	Y	N	Y	2 1/8x30-38	3 1/2	12"	RD
67-69	396-502	2401HKR	2401-1HKR	◆	190	N	N	N	N	Y	N	Y	2 1/4x28-35	4	12"	RD
CHEVY II, NOVA																
68-74	262-400	2304HKR	2304-1HKR	◆	62,209	N	Y	N	N	Y	Y	Y	17/8x30-38	3 1/2	12"	16
68-74	262-400	2308HKR	2308-1HKR	◆	62	N	Y	N	N	Y	Y	Y	2x30-38	3 1/2	12"	16
68-74	396-502	2386HKR	*2386-1HKR	◆		N	Y	N	N	Y	Y	Y	2 1/8x30-38	3 1/2	12"	RD
68-74	396-502	2401HKR	2401-1HKR	◆	190	N	N	N	N	Y	Y	Y	2 1/4x28-35	4	12"	RD
DODGE / PLYMOUTH																
CORONET, CHARGER, CHALLENGER BELVEDERE, ROADRUNNER, BARRACUDA 70-73 (All B & E Bodies)																
62-65	383-426	5320HKR	5320-1HKR	◆	18,200	N	N	N	Y	Y	Y	Y	2 1/8x38-46	3 1/2	12"	SAP
67-74	440	5320HKR	5320-1HKR	◆	18,200	N	N	N	Y	Y	Y	Y	2 1/8x38-46	3 1/2	12"	SAP
DART, SWINGER, DEMON / BARRACUDA, DUSTER (All A Bodies)																
67-74	318-360	5322HKR		◆	18,99,201	N	Y	N	N	Y	N	Y	2x31-37	3 1/2	12"	16
67-75	318-360	5303HKR	*5303-1HKR	◆	201	N	Y	N	N	Y	Y	Y	17/8x32-40	3	12"	SAP
68-75	426 Hemi	5481HKR	*5481-1HKR	◆	13	N	N	N	N	Y	Y	Y	2 1/4x24-30	4	12"	SAP
FORD / MERCURY																
MUSTANG / COUGAR																
67-70	390-428	6375HKR	6375-1HKR	◆		N	Y	N	N	Y	N	Y	2 1/8x30-38	3 1/2	12"	SAP
FAIRLANE / COMET																
66-67	390-428	6375HKR	6375-1HKR	◆		N	Y	N	N	Y	N	Y	2 1/8x30-38	3 1/2	12"	SAP
MAVERICK / COMET																
70-77	390-428	6375HKR	6375-1HKR	◆		N	Y	N	N	Y	N	Y	2 1/8x30-38	3 1/2	12"	SAP

For additional header applications see Engine Swap Section on pages 23-26

Tech Line: 270-781-9741

Footnotes can be found on
Pages 66 - 68

33

- STREET FORCE HEADERS
- CAMARO/FIBERGLASS HEADERS & Y-PIPE
- COMPETITION HEADERS
- MUSTANG GT EXHAUST SYSTEM
- SUPER COMPETITION HEADERS
- RACE HEADERS
- COMPETITION & SUPER COMP EXHAUST KITS
- DIESEL EXHAUST SYSTEMS
- CARBURETOR SYSTEMS
- MUFFLERS
- EXHAUST TIPS
- COMPONENTS & ACCESSORIES
- HEADER & COLLECTOR GASKETS
- FOOTNOTES
- PHOTO GALLERY
- PART # TO PAGE INDEX
- WARRANTY

STREET FORCE HEADERS
CAMARO/FIREBIRD LS1 HEADERS & Y-PIPE
COMPETITION HEADERS
MUSTANG GT EXHAUST SYSTEM
SUPER COMPETITION HEADERS
RACE HEADERS
COMPETITION & SUPER COMP EXHAUST KITS
DIESEL EXHAUST SYSTEMS
CATBACK SYSTEMS
MUFFLERS
EXHAUST TIPS
COMPONENTS & ACCESSORIES
HEADER & COLLECTOR GASKETS
FOOTNOTES
PHOTO GALLERY
PART # TO PAGE INDEX
WARRANTY

SUPER COMPETITION

ADJUSTABLE RACE & WELD-UP RACE KITS

SUPER COMPETITION ADJUSTABLE RACE HEADERS

ENGINES	Baked-On Black PAINT	Metallic Ceramic COATING	EMISSION CODE	FOOTNOTES	TUBE SIZE O.D. IN	COLL SIZE LN O.D. IN	COLL PORT IN	SHAPE
PRO-STOCK, COMP ELIMINATOR, S/C, S/G (Bodied Cars with Tube Chassis)								
396-454	2404HKR	2404-1HKR	◆	88	2 ³ / ₈ -2 ¹ / ₂ x28	4 ¹ / ₂	12	RD
DRAGSTER, S. COMP, COMP ELIMINATOR								
Up Swept 396-502	2310HKR	2310-1HKR	◆		2 ¹ / ₄ x30	4	12	RD
Up Swept 396-502	2410HKR	Chrome	◆		2 ¹ / ₄ x30	4	12	RD
Up Swept 396-502	2405HKR	2405-1HKR	◆		2 ³ / ₈ x30	4 ¹ / ₂	12	RD
Down Swept 396-502	2404HKR	2404-1HKR	◆	50	2 ³ / ₈ -2 ¹ / ₂ x28	4 ¹ / ₂	12	RD
ROADSTER, 23-T								
Chevy B.B.	2404HKR	2404-1HKR	◆	50	2 ³ / ₈ -2 ¹ / ₂ x28	4 ¹ / ₂	12	RD

TIP: Breaking in an engine with ceramic coated headers WILL result in damage to the coating and will VOID all warranties. Ceramic coated headers require several heat cycles to fully cure before they will withstand extreme heat. Hooker recommends using cast iron exhaust manifolds or old headers to break in new engines to avoid coating damage. Please call Hooker tech service at 270-781-9741 for additional information regarding ceramic coated exhaust products.

Y=Yes N=No SAP=Same as Port RD=Round REC=Rectangle



*"Both my stock and super stock car have
 out of the box tubes, and both cars
 have won class at the US Nationals
 in the past two years. Every national event
 I've won has been with Hooker Headers.
 I simply couldn't ask for anything more!"*
*Don Fletcher - 2 NHRA World Championships,
 1 NHRA Divisional Championship,
 26 National Event wins*

For additional header applications see Engine Swap Section on pages 23-26



SUPER COMPETITION WELD-UP RACE KITS

Hooker Weld-up kits work great for racers who need to build custom headers when a specific fit tuned Super Competition header is not available.

Kits come with mandrel bent one piece primaries, two 5/16" flanges and precision formed collectors incorporating unique long transition to provide better flow. Polished stainless steel NHRA contingency header I.D. tags, gaskets and mounting bolts are also included.

Our newest zoomie weld-up kits for Funny Cars and Dragsters are NHRA and IHRA legal and feature 2 1/2" primaries with double tube design. Popular fuel and alcohol engine header flanges are available separately.

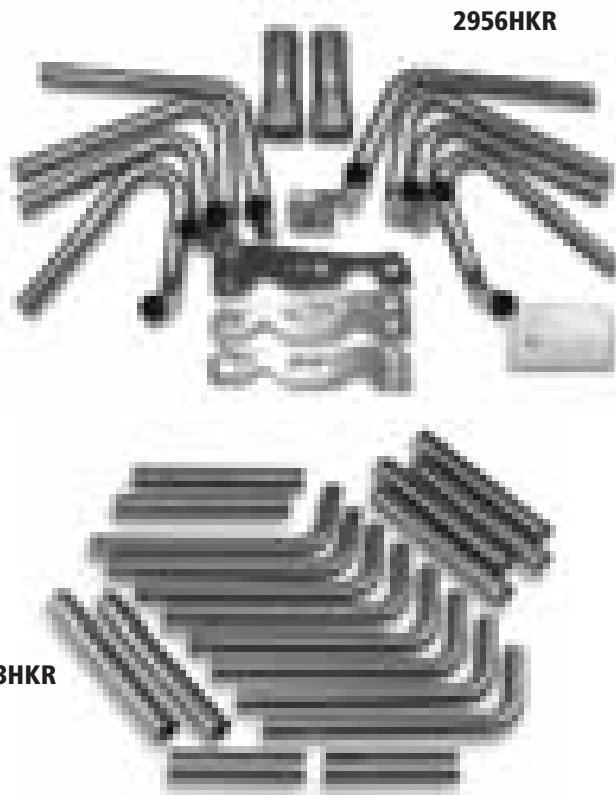

ENGINES	PART NO.	EMISSION CODE	FOOTNOTES	COMMON APPLICATIONS	TUBE SIZE & LENGTH O.D. IN	COLL SIZE O.D. IN	COLL LN IN	PORT SHAPE
S/G, S/C, COMP ELIMINATOR STYLE CARS (FRONT STRUT), SPRINT CARS, SUPER MODIFIED, ROADSTERS								
262-400 Chevy	2954HKR	◆	62		1 7/8 x 36	3 1/2	10	(16)
262-400 Chevy	2956HKR	◆	62		2 x 36	3 1/2	10	(16)
396-454 Chevy	2953HKR	◆			2 1/8 x 40	4	10	RD
396-454 Chevy	2957HKR	◆			2 1/4 x 45	4	12	RD
396-454 Chevy	2959HKR	◆			2 3/8 x 45	4 1/2	12	RD
FUNNY CAR ZOOMIE - FUEL & ALCOHOL								
Universal Fit	5483HKR	◆			2 1/2 x 36	N/A	N/A	N/A
DRAGSTER ZOOMIE - FUEL & ALCOHOL								
Universal Fit	5484HKR	◆			2 1/2 x 26	N/A	N/A	N/A

Y=Yes N=No SAP=Same as Port RD=Round REC=Rectangle

TIP: Breaking in an engine with ceramic coated headers WILL result in damage to the coating and will VOID all warranties. Ceramic coated headers require several heat cycles to fully cure before they will withstand extreme heat. Hooker recommends using cast iron exhaust manifolds or old headers to break in new engines to avoid coating damage. Please call Hooker tech service at 270-781-9741 for additional information regarding ceramic coated exhaust products.

Tech Line: 270-781-9741

Footnotes can be found on Pages 66 - 68

35

- STREET FORCE HEADERS
- CAMARO/FIBERD LSI HEADERS & Y-PIPE
- COMPETITION HEADERS
- MUSTANG GT EXHAUST SYSTEM
- SUPER COMPETITION HEADERS
- RACE HEADERS**
- COMPETITION & SUPER COMP EXHAUST KITS
- DIESEL EXHAUST SYSTEMS
- CATBACK SYSTEMS
- MUFFLERS
- EXHAUST TIPS
- COMPONENTS & ACCESSORIES
- HEADER & COLLECTOR GASKETS
- FOOTNOTES
- PHOTO GALLERY
- PART # TO PAGE INDEX
- WARRANTY

SUPER COMPETITION

CIRCLE TRACK, TRACTOR/PULLER & EXHAUST SYSTEMS

SUPER COMPETITION CIRCLE TRACK RACE HEADERS

- Light weight 18 gauge tubing.
- Machined $\frac{5}{16}$ " Flanges with machined sealing rings for independent port sealing.
- Long transition collectors for increased performance over a broad power curve.
- Specific applications to accommodate mufflers.

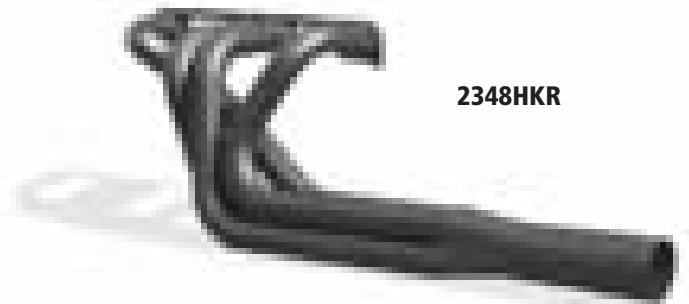

2348HKR

ENGINES	PART NO.	EMISSION CODE	COMMON APPLICATIONS	TUBE SIZE & LENGTH O.D. IN	COLL SIZE O.D. IN	COLL LN IN	PORT SHAPE
Chevy S.B.	2348HKR	◆	Eagle, Gambler, J&J & Maximum Chassis	2 x 35	4	13	RD

SPRINT CARS with Brodix Spread Port Heads

SUPER COMPETITION TRACTOR / PULLER HEADERS

Hooker collector style headers for tractor and truck pullers give racers more useable horsepower and torque.

Our Classic 4 into 1 collector type headers are fully adjustable and feature large $2\frac{1}{4}$ " primaries for big blocks. Hooker puller headers use heli-arc construction with fully heli-brazed flanges on the outside to provide maximum strength.



#2542HKR

ENGINES	PART NO.	FINISH	EMISSION CODE	DESCRIPTION	TUBE SIZE & LENGTH O.D. IN	COLL SIZE O.D. IN	COLL LN IN	PORT SHAPE
396-502	2542HKR	Black	◆	4 into 1 Collector type	2 $\frac{1}{4}$ x28-38	4	18	RD

TRACTORS, TRUCKS - Chevrolet Engines

- STREET FORCE HEADERS
- CAMARO/ FIREBIRD LS1 HEADERS & Y-PIPE
- COMPETITION HEADERS
- MUSTANG GT EXHAUST SYSTEM
- SUPER COMPETITION HEADERS
- RACE HEADERS
- COMPETITION & SUPER COMP EXHAUST KITS
- DIESEL EXHAUST SYSTEMS
- CATBACK SYSTEMS
- MUFFLERS
- EXHAUST TIPS
- COMPONENTS & ACCESSORIES
- HEADER & COLLECTOR GASKETS
- FOOTNOTES
- PHOTO GALLERY
- PART # TO PAGE INDEX
- WARRANTY



SUPER COMPETITION DUAL EXHAUST SYSTEMS

"THE CLASSIC PERFORMANCE EXHAUST SYSTEM"

- Designed to fit Super Competition headers or stock exhaust manifold applications.
- Constructed of large diameter 16-gauge aluminized steel tubing (2 1/2" O.D.) for maximum efficiency (low back-pressure) and long life.
- Each exhaust system is mandrel bent not press bent. Mandrel bending maintains a consistent inside diameter for maximum flow; press bending will crush the pipe, easily reducing volume by more than 10%.
- All systems come without mufflers. We recommend using the Hooker Super Competition, Aero Chamber or Maximum Flow mufflers in a 2 1/2" offset inlet/outlet configuration. Check catalog footnotes on pages 66-68.

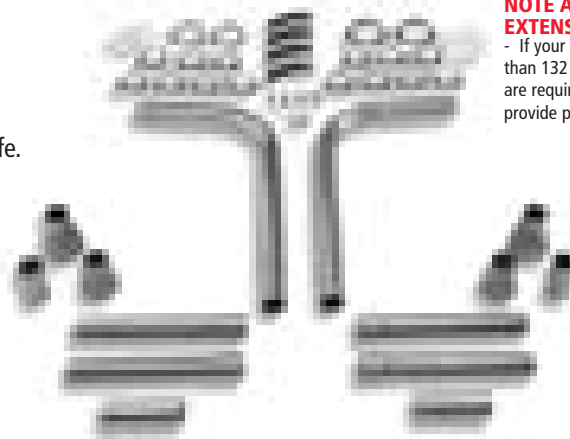

NOTE ABOUT TAILPIPE EXTENSIONS

- If your wheelbase is greater than 132" tailpipe extensions are required to provide proper tailpipe exit.

APPLICATION	YEAR	ENGINE	2WD	4WD	HEADER-BACK	FOOTNOTES
-------------	------	--------	-----	-----	-------------	-----------

DUAL EXHAUST SYSTEMS FOR TRUCKS

CHEVROLET / GMC

BLAZER, SUBURBAN / JIMMY, CARRYALL, YUKON, 1-TON CREW CAB	92-94	396-454		Y	16922HKR*	167
BLAZER / JIMMY	69-91	396-454		Y	16922HKR*	167
1/2, 3/4, 1-TON TRUCKS	83-87	396-454		Y	16922HKR*	167
1/2, 3/4, 1-TON TRUCKS	67-87	396-454		Y	16922HKR*	167

COMPETITION EXHAUST SYSTEMS

APPLICATIONS	YEAR(S)	ENGINE(S)	FOOTNOTES	EXHAUST KITS	
				HEADER - BACK*	MANIFOLD - BACK*
TRUCKS & VANS					
FORD					
F-100, F-250 (2WD)	65-76	352-390	159,160,161	16562HKR	
F-350 (2WD)	67-75	352-390	159,160,161	16562HKR	
F-100, F-150 (4WD)	69-76	352-390	160,162	16564HKR	
Bronco (4WD)	66-77	255-351W		16567HKR	
	78-79	351-400M	140,160	16561HKR	16661HKR
F-150 (4WD)	77-79	351-400M	140,160	16561HKR	16661HKR
F-250 Low Profile, F-350 (4WD)	77 1/2-79	351-400M	140,160	16561HKR	16661HKR
F-100, F-150, F-250 (2&4WD)	80-95	255-302W	160	16565HKR	16665HKR
DODGE / PLYMOUTH					
1/2, 3/4 Ton Truck (2&4WD)	70-93	318-360	101	16552HKR	16652HKR
Ramcharger / Trailduster (4WD)	72-93	318-360	124	16551HKR	

Tech Line: 270-781-9741

Footnotes can be found on
Pages 66 - 68

37

- STREET FORCE HEADERS
- CAMARO/FIBERGLASS HEADERS & Y-PIPE
- COMPETITION HEADERS
- MUSTANG GT EXHAUST SYSTEM
- SUPER COMPETITION HEADERS
- RACE HEADERS
- COMPETITION & SUPER COMP EXHAUST KITS
- DIESEL EXHAUST SYSTEMS
- CORBACK SYSTEMS
- MUFFLERS
- EXHAUST TIPS
- COMPONENTS & ACCESSORIES
- HEADER & COLLECTOR GASKETS
- FOOTNOTES
- PHOTO GALLERY
- PART # TO PAGE INDEX
- WARRANTY

COMPETITION

EXHAUST SYSTEMS & TRUCK FORCE™ DIESEL EXHAUST



- STREET FORCE HEADERS
- CAMARO/FIREBIRD LS1 HEADERS & Y-PIPE
- COMPETITION HEADERS
- MUSTANG GT EXHAUST SYSTEM
- SUPER COMPETITION HEADERS
- RACE HEADERS
- COMPETITION & SUPER COMP EXHAUST KITS
- DIESEL EXHAUST SYSTEMS
- CATBACK SYSTEMS
- MUFFLERS
- EXHAUST TIPS
- COMPONENTS & ACCESSORIES
- HEADER & COLLECTOR GASKETS
- FOOTNOTES
- PHOTO GALLERY
- PART # TO PAGE INDEX
- WARRANTY

COMPETITION EXHAUST SYSTEMS

Designed to fit Hooker Competition header, manifold or catalytic converter back applications. Cat-Back kits install behind the converter and all other applicable emission control devices.

FEATURES:

- Large diameter 16-gauge aluminized steel tubing (2¹/₄" O.D.) for improved efficiency (less back-pressure) and longer life.
- Each exhaust system is mandrel bent not press bent. Mandrel bending maintains a consistent inside diameter for maximum flow; press bending will crush the pipe, easily reducing volume by more than 10%.
- Original equipment tailpipe exit location unless otherwise stated.
- All systems come without mufflers. We recommend using either the Hooker Super Competition, Aero Chamber or Maximum Flow or Turbo mufflers in a 2¹/₄" offset inlet/center outlet configuration.

Check catalog footnotes for any exceptions on pages 66-68.

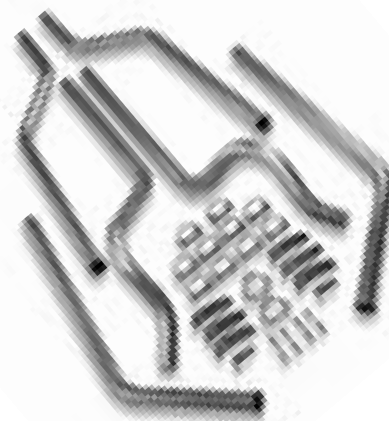

APPLICATIONS	YEAR(S)	ENGINE(S)	FOOTNOTES	EXHAUST KITS	
				HEADER - BACK*	MANIFOLD - BACK*

PASSENGER CARS

CHEVROLET / PONTIAC

Chevy II, Nova	68-79	265-400		16520HKR	16619HKR
Camaro	70-81	265-400	155	16520HKR	16619HKR
Corvette	63-82	265-400	22	16521HKR	
Firebird	70-79	350-455		16541HKR	
Firebird	78-81	265-400		16520HKR	16619HKR

FORD / MERCURY

Mustang / Capri (GT or LX)	79-93	255-302W	1,183	16566HKR	16666HKR
----------------------------	-------	----------	-------	----------	----------

TRUCKS & VANS

CHEVROLET / GMC

Blazer, Suburban / Jimmy, Carryall, Yukon, 1-Ton Crew Cab (2WD)	69-72	265-400	156,157	16522HKR	16621HKR
	73-91	265-400		16523HKR	16622HKR
	92-95	265-400	46,160,195	16532HKR	
1/2, 3/4, 1 Ton Truck (2WD)	73-91	396-502		16624HKR	16626HKR
	63-72	265-400	156,157	16522HKR	16621HKR
	73-87	265-400		16523HKR	16622HKR
1500, 2500, 3500 Truck (2WD)	73-87	396-502		16524HKR	16626HKR
	88-95	265-400	46,160,195	16532HKR	
	69-72	265-400		16527HKR	
Blazer / Jimmy, Yukon (4WD)	73-91	265-400		16528HKR	16624HKR
	92-95	265-400	46,160,195	16533HKR	
	1/2, 3/4, 1 Ton Truck (4WD)	73-87	265-400	16526HKR	16623HKR
1500, 2500, 3500 Truck (4WD)	88-95	265-400	46,160,195	16533HKR	

NOTE ABOUT TAILPIPE EXTENSIONS - If your wheelbase is greater than 132" tailpipe extensions are required to provide proper tailpipe exit. Order extensions from local muffler shop

UNIVERSAL DUAL EXHAUST SYSTEM

This system is the most universal dual exhaust system available. Specially designed reducer flex-tubes make connections to any 3" or 3¹/₂" header collectors simple, but strong enough to last. Large diameter (2¹/₄" o.d., 16 gauge) pipes reduce back-pressure improving engine efficiency.

P/N	Description
16500HKR	Complete system with turbo mufflers

38

www.ilovemyhookerheaders.com



TURBO BACK TRUCK FORCE™ DIESEL TRUCK EXHAUST SYSTEMS

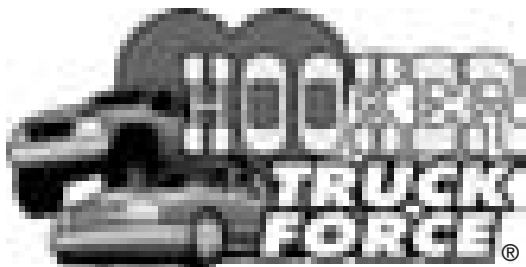

Hooker's new big 4" diesel truck exhaust systems offer improved exhaust flow, lower back-pressure and a reduction in EGT.

They are a direct replacement for the restrictive factory system and include all the necessary clamps, hardware, hangers and tips. They also include comprehensive instructions ideal for the home "do-it-yourself" mechanic. Hooker's turbo back exhaust systems are big, so we recommend the installer also have a helper on hand.

FEATURES/BENEFITS:

- Manufactured from sturdy 16 gauge (.065 wall thickness) 409 grade stainless steel to resist corrosion
- All tubing mandrel bent to ensure smooth exhaust flow.
- All welds are robotic to ensure leak-free construction
- Free-flow 7" muffler reduces back pressure for improved torque
- Perforated muffler exhibits aggressive yet mellow "big rig" diesel sound.
- Big 4" tube reduces harmful exhaust gas temperatures for longer engine and turbocharger life.
- Systems are easy to install and include all the components necessary for installation on any cab/bed/chassis configuration
- Includes polished, slash cut 4" to 5" stainless steel tip(s)



Dodge 94-02 Dual Outlet
16945-2HKR

PART #	APPLICATION
16955-2HKR	94-02 Dodge 5.9L Cummins QC/LB, s.s., single outlet
16945-2HKR	94-02 Dodge 5.9L Cummins QC/LB, s.s., dual outlet
16956-2HKR	03-04 1/2 Dodge 5.9L Cummins CC/LB, s.s., single outlet
16946-2HKR	03-04 1/2 Dodge 5.9L Cummins CC/LB, s.s., dual outlet
16950-2HKR	1999-02 Ford F-250/350 7.3L PS, s.s., single outlet
16940-2HKR	1999-02 Ford F-250/350 7.3L PS, s.s., dual outlet
16954-2HKR	03-05 Ford Powerstroke 6.0L F250/350, s.s., single outlet
16944-2HKR	03-05 Ford Powerstroke 6.0L F250/350, s.s., dual outlet
16952-2HKR	01-04 GM Duramax 6.6L XC/LB, CC/SB, CC/LB, s.s., single outlet
16942-2HKR	01-04 GM Duramax 6.6L XC/LB, CC/SB, CC/LB, s.s., dual outlet

Tech Line: **270-781-9741**

Footnotes can be found on
Pages 66 - 68

39

- STREET FORCE HEADERS
- CAMARO/FIBERGLASS HEADERS & Y-PIPE
- COMPETITION HEADERS
- MUSTANG GT EXHAUST SYSTEM
- SUPER COMPETITION HEADERS
- RACE HEADERS
- COMPETITION & SUPER COMP EXHAUST KITS
- DIESEL EXHAUST SYSTEMS**
- CATBACK SYSTEMS
- MUFFLERS
- EXHAUST TIPS
- COMPONENTS & ACCESSORIES
- HEADER & COLLECTOR GASKETS
- FOOTNOTES
- PHOTO GALLERY
- PART # TO PAGE INDEX
- WARRANTY

DIESEL EXHAUST & CAR CAT-BACKS

LATE MODEL MUSTANG CAT-BACK EXHAUST & STREET FORCE™ CAR CAT-BACKS



SUPER COMPETITION LATE MODEL MUSTANG CATBACKS

"CAT-BACK SYSTEMS AND H-PIPE BALANCE TUBE ASSEMBLIES"

Hooker CAT-BACK systems and H-pipe balance tube assemblies make more horsepower and torque by reducing unnecessary backpressure. Our systems maximize the benefits of modifications such as headers, intake manifold, cam, valve train and ignition. These 2-1/2" mandrel bent systems and H-pipes are manufactured from 16 gauge aluminized tubing to resist heat and corrosion damage.

CAT-BACK systems 16862HKR, 16872HKR and 16863HKR are supplied with an H-pipe balance tube assembly (for off-highway use only) allowing you to replace the stock smaller diameter pipes for better performance and the catalytic converters to prevent damage caused by leaded racing fuel.

To complete your Hooker system we recommend the use of our Aero Chamber muffler part number 21502HKR, Maximum Flow muffler part number 21602HKR, or for those who prefer a traditional turbo muffler sound use Hooker Super Competition Turbo muffler part number 21106HKR. (See pages 42-47 for muffler information).

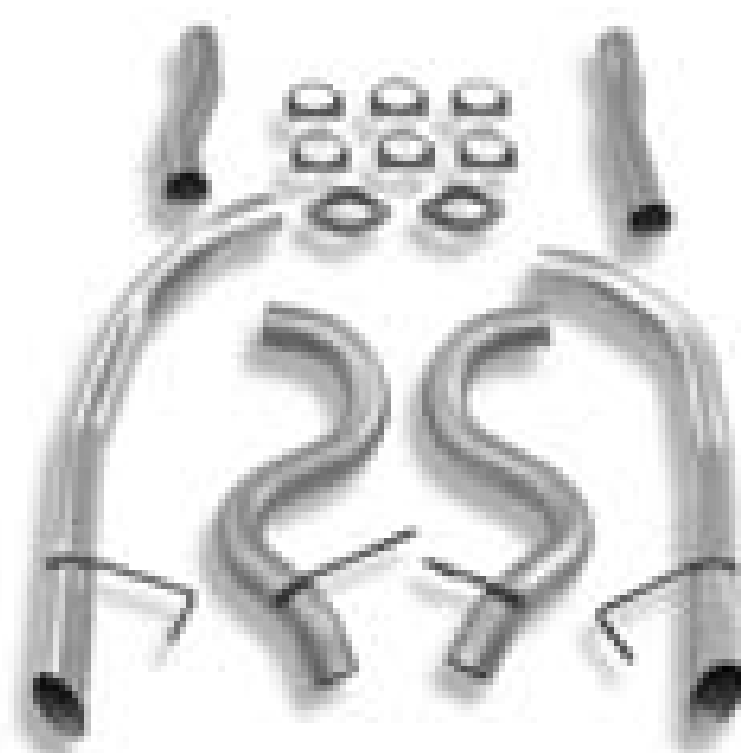

#16870HKR

1979-98 MUSTANG

YEARS	APPLICATION(S)	SYSTEM P/N	SYSTEM P/N W/CHROME TAIL PIPES	INTERMEDIATE PIPE STYLE
79-93*	GT or LX w/5.0L	16862HKR	16872HKR	Off-highway "H" pipe included
94-95	GT w/5.0L	16863HKR		Off-highway "H" pipe included
94-98	3.8L V6	16864HKR	16874HKR	Not Included
NEW 96-02	GT w/4.6L	16870HKR		Not Included

*79-85 applications require the use of a 86-93 "double hump" transmission crossmember

- STREET FORCE HEADERS
- CAMARO/FIREBIRD LS1 HEADERS & Y-PIPE
- COMPETITION HEADERS
- MUSTANG GT EXHAUST SYSTEM
- SUPER COMPETITION HEADERS
- RACE HEADERS
- COMPETITION & SUPER COMP EXHAUST KITS
- DIESEL EXHAUST SYSTEMS
- CATBACK SYSTEMS**
- MUFFLERS
- EXHAUST TIPS
- COMPONENTS & ACCESSORIES
- HEADER & COLLECTOR GASKETS
- FOOTNOTES
- PHOTO GALLERY
- PART # TO PAGE INDEX
- WARRANTY



HOOKER STREET FORCE® CAT-BACK SYSTEMS FOR CARS

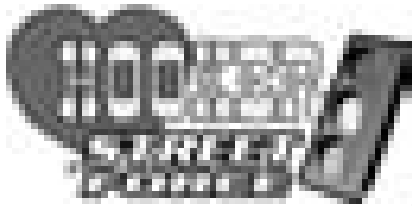

Each exhaust system is mandrel bent not press bent. Mandrel bending maintains a consistent inside diameter for maximum flow; press bending will crush the pipe, easily reducing volume by more than 10%.

Systems exit at stock locations using great looking Hooker large bore exhaust tip extensions (where applicable).



Most Cat-Back systems feature Hooker Aero Chamber mufflers producing more horsepower and torque than all other popular chambered mufflers with a deep throaty powerful sound that will not change with time.

Systems are designed using flanged construction (where applicable) and existing stock hangers for easy installation.

Large diameter 16 gauge aluminized steel tubing for low back-pressure and long life.

#16811HKR

MAKE/MODEL	YEAR(S)	ENGINE/CODE	FOOTNOTE(S)	INTER. PIPE(S) DIAM. (IN)	NO. OF TAILPIPES	TAILPIPE DIAM. (IN)	PART NUMBER
BUICK							
GRAND NATIONAL (TURBO)	86-87	231 V6	100	2 1/2	2	2 1/2	16810HKR
CHEVROLET / PONTIAC							
CAMARO/FIREBIRD	83-85	305 (G,F&7)	177,264	3	2	2 1/2	16822HKR
CAMARO/FIREBIRD	83-92	305 Non HO (H&E)	177,264	3	2	2 1/2	16820HKR
CAMARO/FIREBIRD	86-92	305 HO TPI(G,F&8)	177,210,264	3	2	2 1/2	16823HKR
CAMARO/FIREBIRD	93-95	350 LT-1	174,264	3	2	2 1/2	16827HKR
CAMARO/FIREBIRD (Dual Cat.)	95-97	350 LT-1	264	3	2	2 1/2	16825HKR
CAMARO/FIREBIRD (Dual Cat.)	98-02	350 LS1	264	3	2	2 1/2	16811HKR
CORVETTE	97-04	350 LS-1	264	2 1/2	2	2 1/2	21726HKR
IMPALA SS	94-96	350 LT-1		2 1/2	2	2 1/2	16837HKR
MONTE CARLO SS	86-87	305-350	100	2 1/2	2	3	16810HKR
FORD / MERCURY							
MUSTANG/CAPRI (CHROME TAIL PIPE)	86-93	302W	51,176,208	2 1/2	2	2 1/2	16872HKR
MUSTANG (WITH H-PIPE)	94-95	302W	51,176,199,208	2 1/2	2	2 1/2	16863HKR
MUSTANG	94-98	3.8L V6	176,182,199	2 1/2	2	2 1/2	16864HKR
MUSTANG (CHROME TAIL PIPE)	94-98	3.8L V6	176,182,	2 1/2	2	2 1/2	16874HKR
MUSTANG	96-97	4.6L V8	176,199	2 1/2	2	2 1/2	16870HKR
MUSTANG (STAINLESS W/ TIPS)	05-07	4.6L V8	271	2 1/2	2	2 1/2	21521HKR
MUSTANG (ALUMINIZED W/O TIPS)	05-07	4.6L V8	286	2 1/2	2	2 1/2	21523HKR
MUSTANG (CROSS-PIPE W/ EXTENSION TUBES)	05-07	4.6L V8	270,285	2 1/2	2	2 1/2	16784HKR
MUSTANG (CROSS-PIPE W/O EXTENSION TUBES)	05-07	4.6L V8	285	2 1/2	2	2 1/2	16684HKR

NOTE: Any Hooker header, exhaust system or muffler can be Metallic Ceramic coated. Please specify coating when ordering.

TIP: Breaking in an engine with ceramic coated headers WILL result in damage to the coating and will VOID all warranties. Ceramic coated headers require several heat cycles to fully cure before they will withstand extreme heat. Hooker recommends using cast iron exhaust manifolds or old headers to break in new engines to avoid coating damage. Please call Hooker tech service at 270-781-9741 for additional information regarding ceramic coated exhaust products.

Tech Line: 270-781-9741

41

- STREET FORCE HEADERS
- CAMARO/FIREBIRD LT1 HEADERS & Y-PIPE
- COMPETITION HEADERS
- MUSTANG GT EXHAUST SYSTEM
- SUPER COMPETITION HEADERS
- RACE HEADERS
- COMPETITION & SUPER COMP EXHAUST KITS
- DIESEL EXHAUST SYSTEMS
- CATBACK SYSTEMS
- MUFFLERS
- EXHAUST TIPS
- COMPONENTS & ACCESSORIES
- HEADER & COLLECTOR GASKETS
- FOOTNOTES
- PHOTO GALLERY
- PART # TO PAGE INDEX
- WARRANTY

STREET FORCE HEADERS
CAMARO/FIREBIRD LS1 HEADERS & Y-PIPE
COMPETITION HEADERS
MUSTANG GT EXHAUST SYSTEM
SUPER COMPETITION HEADERS
RACE HEADERS
COMPETITION & SUPER COMP EXHAUST KITS
DIESEL EXHAUST SYSTEMS
CATBACK SYSTEMS
MUFFLERS
EXHAUST TIPS
COMPONENTS & ACCESSORIES
HEADER & COLLECTOR GASKETS
FOOTNOTES
PHOTO GALLERY
PART # TO PAGE INDEX
WARRANTY

AERO CHAMBER™

UNIVERSAL TURBO STYLE & SPECIFIC

AERO CHAMBER™ MUFFLERS - 23% More Flow Than All Other Brands!

AERO CHAMBER™

THE REAL MASTER OF FLOW!

Look inside all other mufflers and you'll find simple glass packing or welded plates. Look inside Hooker's Aero Chamber™ and you'll find the most sophisticated muffler available!

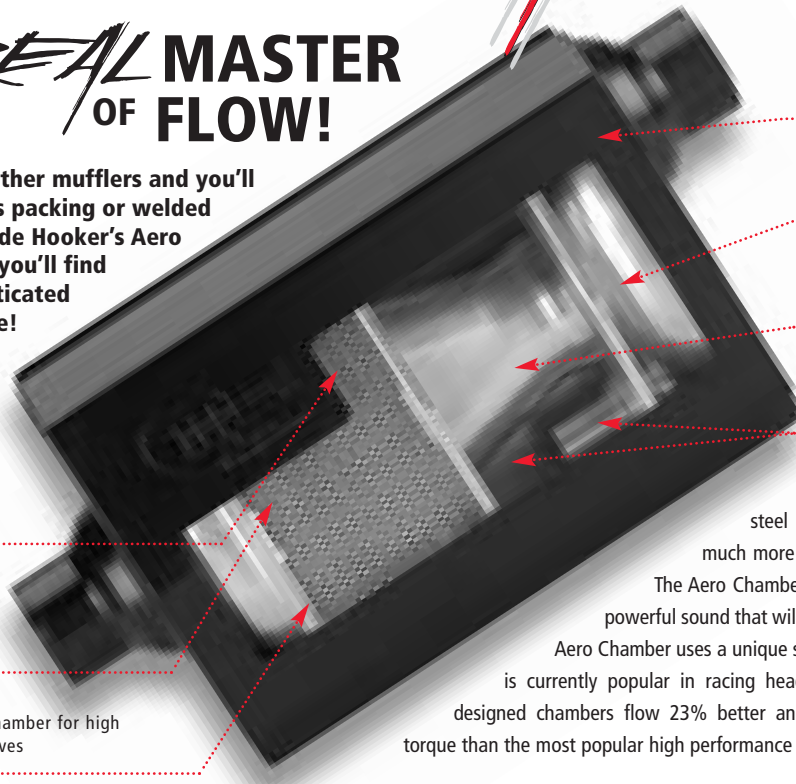

Stainless steel perforated plate eliminates internal rust

Aerodynamic lens directs sound pressure waves out of muffler

Sound absorption chamber for high frequency sound waves

16 gauge aluminized steel case

Aerodynamic lens directs sound pressure waves into acceleration chamber

Stepped acceleration chamber increases exhaust gas velocity for maximum flow

Resonance chamber and tuning tube cancels unwanted frequencies and amplitudes

The all aluminized and stainless steel Aero Chamber is designed to do much more than simply muffle exhaust noise.

The Aero Chamber Muffler produces a deep throaty powerful sound that will not change with time. The Hooker Aero Chamber uses a unique step principal, similar to that which is currently popular in racing header design. The aerodynamically designed chambers flow 23% better and produce more horsepower and torque than the most popular high performance brand.

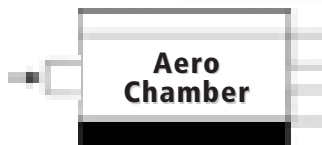

Inlet I.D.	Outlet I.D.	Part Number
3"	2 1/2"	21518HKR



Inlet I.D.	Outlet I.D.	Part Number
2"	2"	21500HKR
2 1/4"	2 1/4"	21501HKR
2 1/2"	2 1/2"	21502HKR
3"	3"	21505HKR
Cutaway Display (As shown above)		21599HKR

Universal Turbo Style

4 3/4" H x 10 1/4" W x 14" L



Inlet I.D.	Outlet I.D.	Part Number
2 1/2"	2 1/2"	21516HKR
3"	3"	21506HKR
3 1/2"	3 1/2"	21507HKR



Inlet I.D.	Outlet I.D.	Part Number
2 1/4"	2 1/4"	21503HKR
2 1/2"	2 1/2"	21504HKR
3"	3"	21530HKR

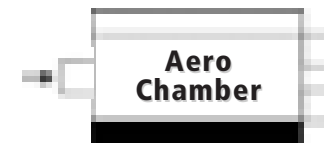

Inlet I.D.	Outlet I.D.	Part Number
2 1/2"	2 1/2"	21508HKR



AERO CHAMBER™ MUFFLERS

Universal Turbo Style - Long Case

4³/₄" H x 10¹/₄" W x 22" L

 Aero Chamber	 Aero Chamber	 Aero Chamber																											
<table border="0"> <tr><td>Inlet I.D.</td><td>Outlet I.D.</td><td>Part Number</td></tr> <tr><td>2¹/₂"</td><td>3"</td><td>21510HKR</td></tr> </table>	Inlet I.D.	Outlet I.D.	Part Number	2 ¹ / ₂ "	3"	21510HKR	<table border="0"> <tr><td>Inlet I.D.</td><td>Outlet I.D.</td><td>Part Number</td></tr> <tr><td>3"</td><td>2¹/₂"</td><td>21701HKR</td></tr> <tr><td>2¹/₄"</td><td>2¹/₄"</td><td>21702HKR</td></tr> <tr><td>2¹/₂"</td><td>2¹/₄"</td><td>21703HKR</td></tr> <tr><td>2¹/₂"</td><td>2¹/₂"</td><td>21704HKR</td></tr> </table>	Inlet I.D.	Outlet I.D.	Part Number	3"	2 ¹ / ₂ "	21701HKR	2 ¹ / ₄ "	2 ¹ / ₄ "	21702HKR	2 ¹ / ₂ "	2 ¹ / ₄ "	21703HKR	2 ¹ / ₂ "	2 ¹ / ₂ "	21704HKR	<table border="0"> <tr><td>Inlet I.D.</td><td>Outlet O.D.</td><td>Part Number</td></tr> <tr><td>3"</td><td>3"</td><td>21512HKR</td></tr> </table>	Inlet I.D.	Outlet O.D.	Part Number	3"	3"	21512HKR
Inlet I.D.	Outlet I.D.	Part Number																											
2 ¹ / ₂ "	3"	21510HKR																											
Inlet I.D.	Outlet I.D.	Part Number																											
3"	2 ¹ / ₂ "	21701HKR																											
2 ¹ / ₄ "	2 ¹ / ₄ "	21702HKR																											
2 ¹ / ₂ "	2 ¹ / ₄ "	21703HKR																											
2 ¹ / ₂ "	2 ¹ / ₂ "	21704HKR																											
Inlet I.D.	Outlet O.D.	Part Number																											
3"	3"	21512HKR																											
 Aero Chamber		 Aero Chamber																											
<table border="0"> <tr><td>Inlet I.D.</td><td>Outlet I.D.</td><td>Part Number</td></tr> <tr><td>3"</td><td>3"</td><td>21513HKR</td></tr> <tr><td>3¹/₂"</td><td>3¹/₂"</td><td>21509HKR</td></tr> </table>	Inlet I.D.	Outlet I.D.	Part Number	3"	3"	21513HKR	3 ¹ / ₂ "	3 ¹ / ₂ "	21509HKR		<table border="0"> <tr><td>Inlet I.D.</td><td>Outlet I.D.</td><td>Part Number</td></tr> <tr><td>2¹/₄"</td><td>2¹/₂"</td><td>21710HKR</td></tr> </table>	Inlet I.D.	Outlet I.D.	Part Number	2 ¹ / ₄ "	2 ¹ / ₂ "	21710HKR												
Inlet I.D.	Outlet I.D.	Part Number																											
3"	3"	21513HKR																											
3 ¹ / ₂ "	3 ¹ / ₂ "	21509HKR																											
Inlet I.D.	Outlet I.D.	Part Number																											
2 ¹ / ₄ "	2 ¹ / ₂ "	21710HKR																											

Specific Fit (Replacement) Applications

 Aero Chamber	 Aero Chamber	 Aero Chamber
82-92 Camaro/Firebird #21720HKR	93-99 Camaro/Firebird #21721HKR	88-94 Pickups #21700HKR**
 Aero Chamber	 Aero Chamber	 Aero Chamber
Universal Camaro/Firebird #21729HKR (Also used in Hooker Super Comp cat-backs)	94-95 Pickups #21722HKR	84-95 Corvette (excludes ZR-1) #21725HKR (Includes Stainless Steel 304 Polished Tips)
Ford		
 Aero Chamber	 Aero Chamber	 Aero Chamber
79-99 Mustang #21503HKR*	79-99 Mustang #21504HKR*	87-96 Pickups (302-351W) #21760HKR

* To use as replacement on Mustang, cut off inlet/outlet pipes flush with stock mufflers and weld in place. Stock hangers must be welded to new muffler.
 ** Some trucks in 1994 used a single exhaust pipe outlet. Use #21722HKR for these applications.

Tech Line: 270-781-9741

- STREET FORCE HEADERS
- CAMARO/FIREBIRD LSI HEADERS & Y-PIPE
- COMPETITION HEADERS
- MUSTANG GT EXHAUST SYSTEM
- SUPER COMPETITION HEADERS
- RACE HEADERS
- COMPETITION & SUPER COMP EXHAUST KITS
- DIESEL EXHAUST SYSTEMS
- CATBACK SYSTEMS
- MUFFLERS
- EXHAUST TIPS
- COMPONENTS & ACCESSORIES
- HEADER & COLLECTOR GASKETS
- FOOTNOTES
- PHOTO GALLERY
- PART # TO PAGE INDEX
- WARRANTY

- STREET FORCE HEADERS
- CAMARO/FIREBIRD LS1 HEADERS & Y-PIPE
- COMPETITION HEADERS
- MUSTANG GT EXHAUST SYSTEM
- SUPER COMPETITION HEADERS
- RACE HEADERS
- COMPETITION & SUPER COMP EXHAUST KITS
- DIESEL EXHAUST SYSTEMS
- CATBACK SYSTEMS
- MUFFLERS**
- EXHAUST TIPS
- COMPONENTS & ACCESSORIES
- HEADER & COLLECTOR GASKETS
- FOOTNOTES
- PHOTO GALLERY
- PART # TO PAGE INDEX
- WARRANTY

AERO CHAMBER™ & MAXIMUM FLOW™

SPECIFIC, UNIVERSAL BI-DIRECTIONAL & TURBO STYLE MUFFLERS

AERO CHAMBER™ MUFFLERS

Ford

NEW!

Aero Chamber

2005 Mustang
 #21521HKR - Stainless steel muffler set with tips
 #21523HKR - Aluminized steel(black) muffler set without tips

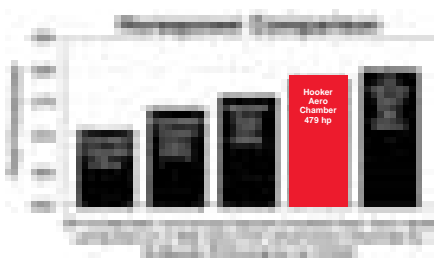
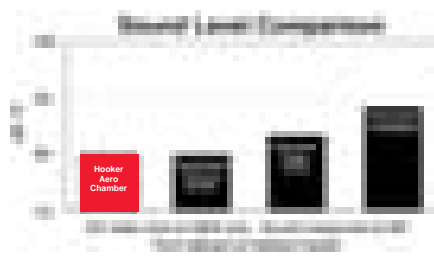
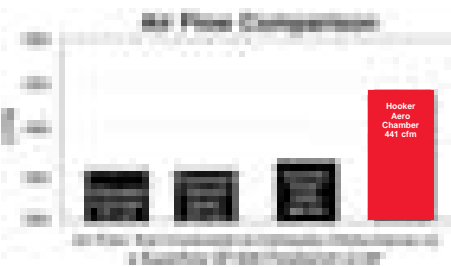

Can Your Muffler Do This?

Look inside all other mufflers and you'll find simple glass packing or welded plates. Look inside Hooker's Aero Chamber and you'll find the most sophisticated and durable muffler available. Three internal bulkheads fully support the case for unsurpassed structural integrity while a unique stepped acceleration chamber provides that extra tire-turning torque your truck is looking for. So, beat, bang and crawl your way to the top with Hooker's Aero Chamber muffler!

HOOKER

Hear the Aero Chamber go to www.ilovemyhookerheaders.com



MAXIMUM FLOW™ MUFFLERS - Straight Thru Designed

The Hooker Maximum Flow muffler actually flows 99% and produces more horsepower and torque than a 2-1/2" open pipe. The Maximum Flow is constructed of all aluminized and stainless steel and uses a high temperature packing material to absorb excessive noise while allowing a mellow powerful sound. As with all absorption type silencers, the Maximum Flow will be most effective for sound control with lower compression (8.5 to 1 and lower) motors with conservative camshafts and with applications using catalytic converter(s). The Maximum Flow flows either direction, allowing for easy installation.

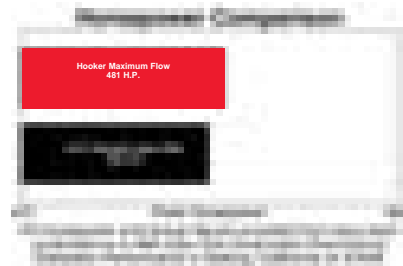
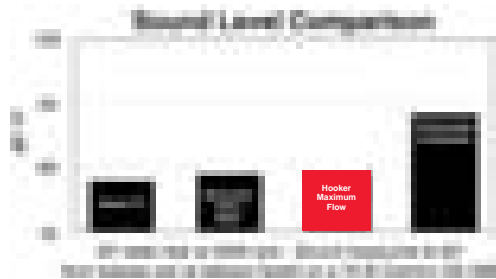
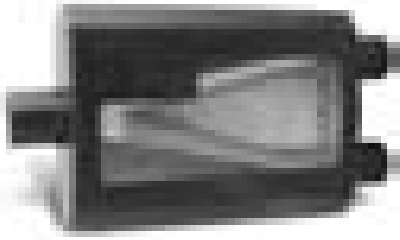

Universal Turbo Style - Long Case 4³/₄" H x 10¹/₄" W x 22" L

Universal Bi-Directional Turbo Style

4³/₄" H x 10¹/₄" W x 14" L

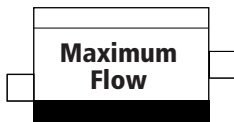

Inlet I.D.	Outlet I.D.	Part Number
2"	2"	21600HKR
2 ¹ / ₄ "	2 ¹ / ₄ "	21601HKR
2 ¹ / ₂ "	2 ¹ / ₂ "	21602HKR
3"	3"	21605HKR



Inlet I.D.	Outlet I.D.	Part Number
2 ¹ / ₄ "	2 ¹ / ₄ "	21603HKR
2 ¹ / ₂ "	2 ¹ / ₂ "	21604HKR
3"	3"	21630HKR

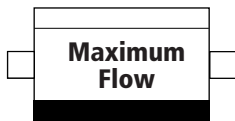

Inlet I.D.	Outlet I.D.	Part Number
2"	2"	21612HKR
2 ¹ / ₄ "	2 ¹ / ₄ "	21613HKR
2 ¹ / ₂ "	2 ¹ / ₂ "	21614HKR
3"	3"	21606HKR
4"	4"	21609HKR



Inlet I.D.	Outlet I.D.	Part Number
2 ¹ / ₄ "	2 ¹ / ₄ "	21608HKR
2 ¹ / ₂ "	2 ¹ / ₂ "	21607HKR
Cutaway Display		21699HKR

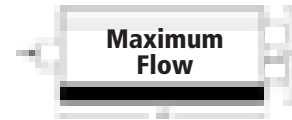

Inlet I.D.	Outlet I.D.	Part Number
3"	2 ¹ / ₄ "	21800HKR
3"	2 ¹ / ₂ "	21801HKR
2 ¹ / ₄ "	2 ¹ / ₄ "	21802HKR
2 ¹ / ₂ "	2 ¹ / ₄ "	21803HKR
2 ¹ / ₂ "	2 ¹ / ₂ "	21804HKR



Inlet I.D.	Outlet I.D.	Part Number
2 ¹ / ₄ "	2 ¹ / ₂ "	21810HKR

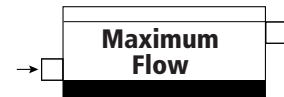

Inlet I.D.	Outlet I.D.	Part Number
3"	3"	21610HKR



Inlet I.D.	Outlet I.D.	Part Number
3"	3"	21611HKR

Tech Line: 270-781-9741

45

- STREET FORCE HEADERS
- CAMARO/FIBERGLASS HEADERS & Y-PIPE
- COMPETITION HEADERS
- MUSTANG GT EXHAUST SYSTEM
- SUPER COMPETITION HEADERS
- RACE HEADERS
- COMPETITION & SUPER COMP EXHAUST KITS
- DIESEL EXHAUST SYSTEMS
- CORBACK SYSTEMS
- MUFFLERS
- EXHAUST TIPS
- COMPONENTS & ACCESSORIES
- HEADER & COLLECTOR GASKETS
- FOOTNOTES
- PHOTO GALLERY
- PART # TO PAGE INDEX
- WARRANTY

MAXIMUM FLOW™, SUPER COMP & COMP TURBO MUFFLERS

MAXIMUM FLOW™ MUFFLERS - Straight Thru Designed

Specific Fit (Replacement) Applications

Chevy / GMC

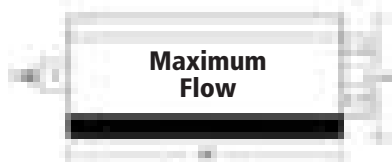

88-94 Pickups 350c.i.
#21800HKR

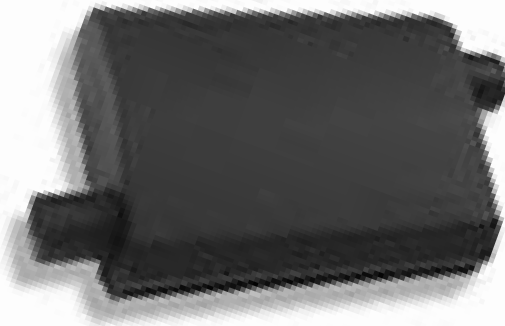

Ford

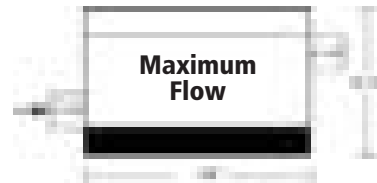

79-99 Mustang
#21603HKR*

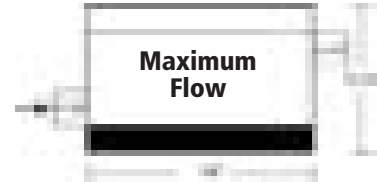

79-99 Mustang
#21604HKR*

* To use as replacement on Mustang, cut off inlet/outlet pipes flush with stock mufflers and weld in place. Stock hangers must be welded to new muffler.

MAXIMUM FLOW™ SIDEPIPE MUFFLER



21046HKR

This high performance muffler has been developed for vehicles with 4" sidepipes, such as 1965-74 Corvettes or vehicles equipped with Hooker Super Competition Roadster and Side Mount Headers. These mufflers produce an average of 23% more power than open headers and feature a high-flow, perforated core that operates at 99% efficiency. High temperature packing material absorbs noise while producing a powerful mellow sound. These mufflers, as tested on a 1968 Corvette with a 427 cu inch engine increased horsepower by 40 at a peak of 5500RPM and 20 ft.-lbs. at peak of 4500RPM versus a leading aftermarket undercar header/turbo-style muffler combination. The outer case is constructed of durable 16 gauge aluminized steel protected by electrostatically applied high-temperature black paint. The inlet/outlet is a 2.5" perforated core in a 4" casing.



SUPER COMPETITION TURBO MUFFLERS

FEATURES:

- Lowest back-pressure (measured in inches of Mercury @ 200 CFM) of all popular turbo mufflers tested.*
- Large diameter flow tubes.
- Careful application of aerodynamic principles to achieve maximum exhaust gas flow.
- This compact muffler design flows either direction, allowing easy installation with 2", 2-1/4", 2-1/2" and 3" I.D. systems.
- Powerful exhaust sound on acceleration with quiet operation at idle and cruising speeds.
- All aluminized and double wrapped steel construction for longer life (Metallic Ceramic Coating available).
- Unique design to prevent structural damage from vibration, heat and backfires with internal drainage system to reduce corrosion.



Diagram for part Numbers
**21104HKR, 21105HKR
21106HKR**

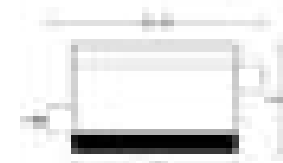

Diagram for part Numbers
21109HKR



Diagram for part Numbers
21107HKR

Part No.	Inlet and Outlet Sizes I.D.	Case Type	Case Size Height/Width	Case Lgth	Overall Lgth
21104HKR	2"	Oval- Offset/Center	4 1/4" x 9 3/4"	14"	18 1/2"
21105HKR	2 1/4"	Oval- Offset/Center	4 1/4" x 9 3/4"	14"	18 1/2"
21106HKR	2 1/2"	Oval- Offset/Center	4 1/4" x 9 3/4"	14"	18 1/2"
21109HKR	2 1/2"	Oval- Offset/Offset	4 1/4" x 9 3/4"	14"	18 1/2"
21107HKR	3"	Oval- Offset/Center	5 1/2" x 11"	20"	27"

COMPETITION TURBO MUFFLERS

FEATURES:

- Low back-pressure baffle network using large free flowing 2 1/4" cores with reverse flow.
- This compact muffler design flows either direction, allowing easy installation with 2", 2 1/4" and 2 1/2" I.D. systems available.
- Improved engine efficiency results in better performance and economy.
- Throaty exhaust sound on acceleration with quiet operation at idle and cruising speeds.
- Double wrapped aluminized steel construction.

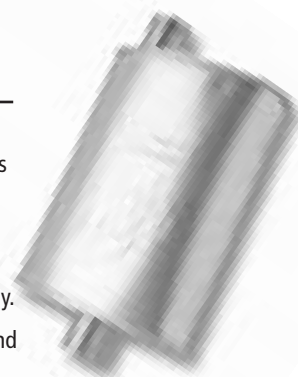

Diagram for part Numbers
**21004HKR, 21005HKR
21006HKR**



Diagram for part Numbers
21007HKR, 21008HKR

Part No.	Inlet and Outlet Sizes I.D.	Case Type	Case Size Height/Width	Case Lgth	Overall Lgth
21004HKR	2"	Oval-Offset/Center	4 1/4" x 9 3/4"	14"	18 1/2"
21005HKR	2 1/4"	Oval-Offset/Center	4 1/4" x 9 3/4"	14"	18 1/2"
21006HKR	2 1/2"	Oval-Offset/Center	4 1/4" x 9 3/4"	14"	18 1/2"
21007HKR	2 1/4"	Oval-Offset/Offset	4 1/4" x 9 3/4"	14"	18 1/2"
21008HKR	2 1/2"	Oval-Offset/Offset	4 1/4" x 9 3/4"	14"	18 1/2"

Tech Line: 270-781-9741

Footnotes can be found on
Pages 66 - 68

47

- STREET FORCE HEADERS
- CAMARO/FIBERGLASS HEADERS & Y-PIPE
- COMPETITION HEADERS
- MUSTANG GT EXHAUST SYSTEM
- SUPER COMPETITION HEADERS
- RACE HEADERS
- COMPETITION & SUPER COMP EXHAUST KITS
- DIESEL EXHAUST SYSTEMS
- CORBACK SYSTEMS
- MUFFLERS
- EXHAUST TIPS
- COMPONENTS & ACCESSORIES
- HEADER & COLLECTOR GASKETS
- FOOTNOTES
- PHOTO GALLERY
- PART # TO PAGE INDEX
- WARRANTY

TUNED FLOW® & SUPER COMP SPECIALTY

SLIP-ON, STAINLESS & UNIVERSAL TURNOUT MUFFLERS

TUNED FLOW® MUFFLERS

Adjustable SOUND and PERFORMANCE without Disassembly!

Sound and flow of the HOOKER Tuned Flow® muffler can be adjusted up to 40% simply by rotating the internal barrel.

The Tuned Flow® muffler is designed for weld-on or clamp-on installation at the end of tailpipes or header collectors. The housing comes with a welded U-channel bracket and chrome clamp for easy mounting on most applications.

Tuned Flow® mufflers are ideal for midgets, dwarf cars, street rods, performance street machines or performance sport compacts.

Tuned Flow® mufflers are finished in show-quality chrome.

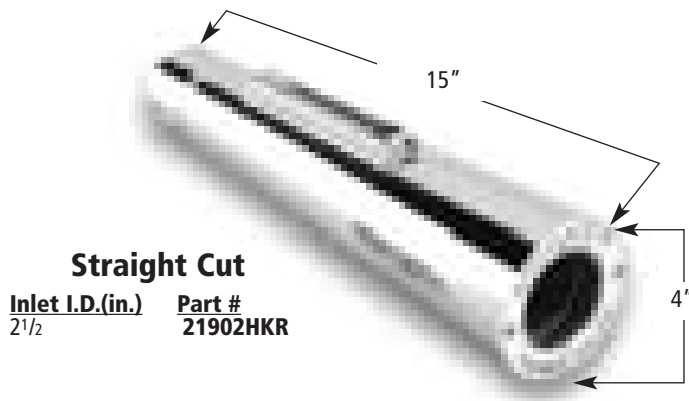

Precise Tuning of Performance

Loosen and turn to "T" for maximum Mid RPM Torque or "H" for High RPM Horsepower or any position in between for infinite adjustment.

STREET FORCE HEADERS
CAMARO/ FIREBIRD LS1 HEADERS & Y-PIPE
COMPETITION HEADERS
MUSTANG GT EXHAUST SYSTEM
SUPER COMPETITION HEADERS
RACE HEADERS
COMPETITION & SUPER COMP EXHAUST KITS
DIESEL EXHAUST SYSTEMS
CATBACK SYSTEMS
MUFFLERS
EXHAUST TIPS
COMPONENTS & ACCESSORIES
HEADER & COLLECTOR GASKETS
FOOTNOTES
PHOTO GALLERY
PART # TO PAGE INDEX
WARRANTY



SUPER COMPETITION SPECIALTY EXHAUST PRODUCTS



#31015HKR

ELITE STAINLESS UNIVERSAL MUFFLERS

Elite Series Stainless Mufflers without collector flanges are perfect for really special hot rods or performance street machines. These mufflers utilize a 3½" diameter case, high temperature pack material and large 2" cores. Manufactured from 304 aircraft quality polished stainless steel, the mufflers are available in all popular inlet/outlet sizes.

Part #	Description (in.)
31015HKR	26 Long. 2½ I.D. Inlet and Outlet Diameter



#21037HKR

UNIVERSAL TURNOUT MUFFLERS

Hooker offers universal bolt-on turnout style mufflers which are perfect for Jeeps, Broncos and Landcruisers using fenderwell exit headers. By using a spring for universal mounting, these 3½" O.D. case sidemount mufflers will bolt to any 3-bolt 3" O.D. ringed collectors. We supply mounting hardware for proper muffler support. The mufflers use a welded all metal core for longer life and are engineered to control sound without restricting flow.

Available in "show quality" chrome or heat cured black high temperature paint. We polish chrome mufflers before and after welding to insure a perfect finish. Sold in pairs.

Part #	Description	Sidetube O.D.	Recommended Header Part #
21037HKR	30" Chrome	3½	9401, 9810, 9820, 9825, 9814

Tech Line: 270-781-9741

49

STREET FORCE
HEADERS

CAMARO/
FERRISD LSI
HEADERS &
Y-PIPE

COMPETITION
HEADERS

MUSTANG GT
EXHAUST
SYSTEM

SUPER
COMPETITION
HEADERS

RACE
HEADERS

COMPETITION
& SUPER COMP
EXHAUST KITS

DIESEL EXHAUST
SYSTEMS

CATBACK
SYSTEMS

MUFFLERS

EXHAUST
TIPS

COMPONENTS
& ACCESSORIES

HEADER &
COLLECTOR
GASKETS

FOOTNOTES

PHOTO
GALLERY

PART #
TO PAGE
INDEX

WARRANTY

STREET FORCE HEADERS
CAMARO/FIREBIRD LS1 HEADERS & Y-PIPE
COMPETITION HEADERS
MUSTANG GT EXHAUST SYSTEM
SUPER COMPETITION HEADERS
RACE HEADERS
COMPETITION & SUPER COMP EXHAUST KITS
DIESEL EXHAUST SYSTEMS
CATBACK SYSTEMS
MUFFLERS
EXHAUST TIPS
COMPONENTS & ACCESSORIES
HEADER & COLLECTOR GASKETS
FOOTNOTES
PHOTO GALLERY
PART # TO PAGE INDEX
WARRANTY

COMPONENTS & ACCESSORIES

SUPER COMP SPECIALTY EXHAUST,
UNIVERSAL SIDEMOUNTS & TIPS

SUPER COMPETITION SPECIALTY EXHAUST PRODUCTS

SIDETUBE SLIP-IN MUFFLERS

For 4" sidetube sound control, Hooker builds long lasting slip-in mufflers. These mufflers are easily removed for racing purposes and are available in a performance style glasspack (#21021HKR) or our quieter all metal reverse flow style (#21002HKR and #21003HKR). Hooker mufflers produce a high level of sound control without restricting engine efficiency. Sold in pairs.

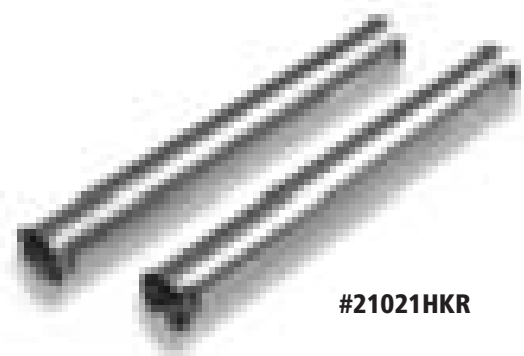

#21021HKR

Part #	Description
21021HKR	4" sidetube slip-in muffler - glasspack
21002HKR	4" sidetube slip-in muffler - small block reverse flow
21003HKR	4" sidetube slip-in muffler - big block reverse flow
21046HKR	4" Maximum Flow™ sidepipe muffler - straight thru flow

WARNING: Sidepipes get very hot. Avoid all contact with sidepipes for one hour after operating vehicle.

UNIVERSAL SIDEMOUNTS

Give any car that classic sidetube header look!

Hooker 4 inch Universal Sidemounts reduce back-pressure, improving low end torque for better performance and fuel economy.

The classic Hooker 4 into 1 (**NOTE:** 3 tubes are dummies) collectors utilize huge 2 1/8" diameter primaries mandrel bent to maintain a consistent inside diameter for maximum flow. Our 4" 16 gauge sidepipes utilize long lasting slip-in mufflers. These mufflers are easily removed for racing purposes and are available in a performance style (glasspack) or quieter reverse flow style (all metal).

Show quality chrome finish.

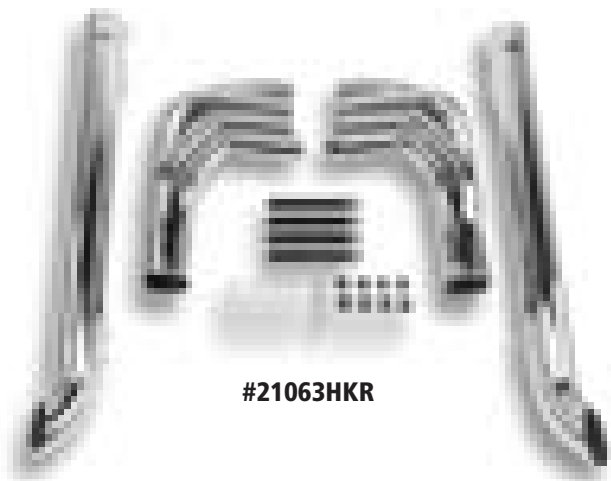

#21063HKR

Part #	Description	Required Hooker Muffler
21063HKR	65" Chrome	21021HKR or 21002HKR (see above) or 21046HKR



HOOKER® EXHAUST TIPS

LARGE BORE ROLLED STYLE

Now, a large bore look with the quality you've been waiting for. Available with or without a resonator, our rolled style tip features show quality chrome, black powdercoating, aluminized internal parts with drainage system to reduce corrosion and heat resistant Hooker decaling. The perfect look for your late model or sport compact car.

With Resonator

Part #	Inlet Size	Outlet Size	Overall Length
22000HKR	1 ⁷ / ₈	3	10
22001HKR	2	3	10
22002HKR	2 ¹ / ₄	3	10
22005HKR	2 ¹ / ₄	3 ¹ / ₂	10
22006HKR	2 ¹ / ₂	3 ¹ / ₂	10
22010HKR	2 ¹ / ₂	4	10
22011HKR	3	4	10

Without Resonator

Part #	Inlet Size	Outlet Size	Overall Length
22028HKR	2 ¹ / ₂	3 ¹ / ₂	10
22032HKR	2 ¹ / ₂	4	10
22033HKR	3	4	10

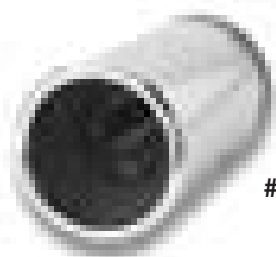

#22010HKR

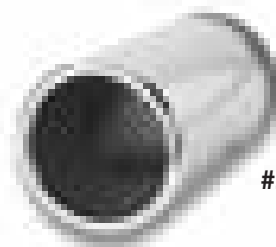

#22032HKR

LARGE BORE EXHAUST TIP EXTENSIONS

An affordable way to personalize your stock or custom built exhaust system. These show quality chrome tips feature larger outlet sizes (3", 3¹/₂") which look great on late model cars and trucks. Each tip has a welded on pinch clamp and bolt to make installation simple.

Single Tip

Part #	Inlet Size	Outlet Size	Overall Length	Tip Style
22200HKR	2 ¹ / ₄	3	11	RD
22201HKR	2 ¹ / ₂	3	11	RD
22202HKR	2 ¹ / ₄	3	11	SL
22203HKR	2 ¹ / ₂	3	11	SL
22204HKR	2 ¹ / ₄	3 ¹ / ₂	11	RD
22205HKR	2 ¹ / ₂	3 ¹ / ₂	11	RD
22206HKR	3	3 ¹ / ₂	9	RD
22207HKR	2 ¹ / ₄	3 ¹ / ₂	11	SL
22208HKR	2 ¹ / ₂	3 ¹ / ₂	11	SL
22209HKR	3	3 ¹ / ₂	9	SL

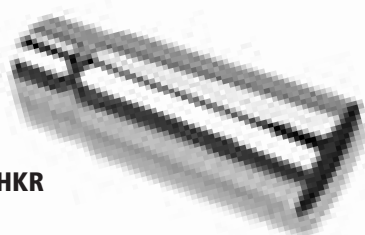

#22209HKR

Dual Tip

Part #	Inlet Size	Outlet Size	Overall Length	Tip Style
22303HKR	2 ¹ / ₂	3	10 ³ / ₄	SL
22304HKR*	2 ¹ / ₂	3	10 ³ / ₄	RD

* Polished Stainless



#22304HKR

270-781-9741

- STREET FORCE HEADERS
- CAMARO/FIBERGLASS HEADERS & Y-PIPE
- COMPETITION HEADERS
- MUSTANG GT EXHAUST SYSTEM
- SUPER COMPETITION HEADERS
- RACE HEADERS
- COMPETITION & SUPER COMP EXHAUST KITS
- DIESEL EXHAUST SYSTEMS
- CATBACK SYSTEMS
- MUFFLERS
- EXHAUST TIPS
- COMPONENTS & ACCESSORIES
- HEADER & COLLECTOR GASKETS
- FOOTNOTES
- PHOTO GALLERY
- PART # TO PAGE INDEX
- WARRANTY

COMPONENTS & ACCESSORIES

EXHAUST TIPS, SIDE PIPE MUFFLER & FLANGE KITS

HOOKER® EXHAUST TIPS

CLASSIC EUROPEAN STYLE

A perfect way to finish off your exhaust system. Available with or without resonators, our tips feature a combination of black powder-coating, high luster chrome (polished stainless optional) and a heat resistant Hooker decal giving your exhaust system the classic finish it deserves.

Dual Tip with Resonator

Part #	Inlet Size	Outlet Size	Overall Length	Tip Style
21401HKR	1 7/8	2 1/2	14	RD
31407HKR*	2 1/4	2 1/2	14	SL
21430HKR	2 1/2	2 1/2	14	SL
21431HKR	2 1/2	3	14	SL
21416HKR	2 1/8	2 1/2	14	RD

Dual Tip without Resonator

Part #	Inlet Size	Outlet Size	Overall Length	Tip Style
21417HKR	2 1/4	2 1/2	14	SL
31417HKR*	2 1/4	2 1/2	14	SL
21433HKR	2 1/2	3	14	SL

(*) Stainless

#21431HKR



#21433HKR



ELITE STAINLESS EXHAUST TIP EXTENSIONS

These tip extensions are made from 304 aircraft quality polished stainless steel. Each tip has a welded on pinch clamp and bolt to make installation simple. Give your car or truck a present that will look like new for years to come.



Part #	Inlet Size	Outlet Size	Overall Length	Tip Style
31503HKR	2 1/2	2 1/2	12	slash

For additional header applications see Engine Swap Section on pages 23-26

- STREET FORCE HEADERS
- CAMARO/FIREBIRD LS1 HEADERS & Y-PIPE
- COMPETITION HEADERS
- MUSTANG GT EXHAUST SYSTEM
- SUPER COMPETITION HEADERS
- RACE HEADERS
- COMPETITION & SUPER COMP EXHAUST KITS
- DIESEL EXHAUST SYSTEMS
- CATBACK SYSTEMS
- MUFFLERS
- EXHAUST TIPS
- COMPONENTS & ACCESSORIES
- HEADER & COLLECTOR GASKETS
- FOOTNOTES
- PHOTO GALLERY
- PART # TO PAGE INDEX
- WARRANTY



SUPER COMPETITION COMPONENTS & ACCESSORIES

MAX FLOW™ SIDEPIPE MUFFLER



21046HKR

This high performance muffler has been developed for vehicles with 4" sidepipes, such as 1965-74 Corvettes or vehicles equipped with Hooker Super Competition Roadster and Side Mount Headers. These mufflers produce an average of 23% more power than open headers and feature a high-flow, perforated core that operates at 99% efficiency. High temperature packing material absorbs noise while producing a powerful mellow sound. These mufflers, as tested on a 1968 Corvette with a 427 cu inch engine increased horsepower by 40 at a peak of 5500RPM and 20 ft.-lbs. at peak of 4500RPM versus a leading aftermarket undercar header/turbo-style muffler combination. The outer case is constructed of durable 16 gauge aluminized steel protected by electrostatically applied high-temperature black paint. The inlet/outlet is a 2.5 perforated core in a 4" casing.

FLANGE KITS WITH WELDED STUBS

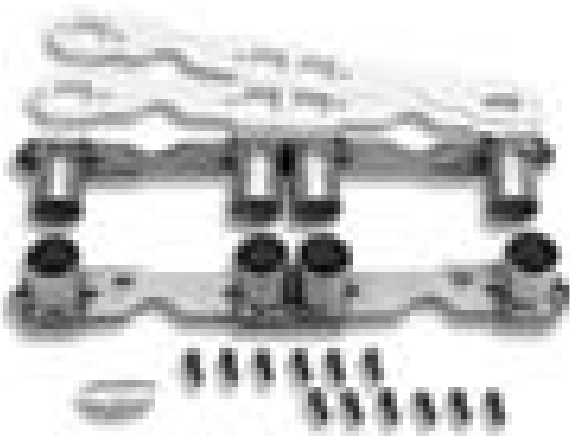

11622HKR

Hooker offers a complete line of fully welded flange kits with stubs. We have taken the most difficult and time consuming part of building a custom header and done it for you! Each flange has a 2" long stub welded to it and is machine milled, not ground, to provide a perfect sealing surface. The flange is then internally deburred and heli-brazed on the outside to provide maximum strength. Flange kits come with gaskets, bolts and polished stainless steel NHRA contingency I.D. header tags.

Part No.	Application	Port Shape	Primary Tube Size O.D.(in.)
11621HKR	Chevy 262-400	Square	1 ⁵ / ₈
11622HKR	Chevy 262-400	Square	1 ³ / ₄
11626HKR	Chevy 396-454	Round	2 ¹ / ₈
11629HKR	Chevy 396-454	Round	2 ¹ / ₄
11650HKR	Mopar 273-360	SAP	1 ³ / ₄
11654HKR	Mopar 383-440	Rect	2
11661HKR	Ford 260-351W	Rect	1 ⁵ / ₈
11666HKR	Ford 429-460	Oval	1 ⁷ / ₈

Tech Line: 270-781-9741

53

STREET FORCE
HEADERS

CAMARO/
FIBERED LSI
HEADERS &
Y-PIPE

COMPETITION
HEADERS

MUSTANG GT
EXHAUST
SYSTEM

SUPER
COMPETITION
HEADERS

RACE
HEADERS

COMPETITION
& SUPER COMP
EXHAUST KITS

DIESEL EXHAUST
SYSTEMS

CATBACK
SYSTEMS

MUFFLERS

EXHAUST
TIPS

COMPONENTS
& ACCESSORIES

HEADER &
COLLECTOR
GASKETS

FOOTNOTES

PHOTO
GALLERY

PART #
TO PAGE
INDEX

WARRANTY

STREET FORCE HEADERS
CAMARO/FIREBIRD LS1 HEADERS & Y-PIPE
COMPETITION HEADERS
MUSTANG GT EXHAUST SYSTEM
SUPER COMPETITION HEADERS
RACE HEADERS
COMPETITION & SUPER COMP EXHAUST KITS
DIESEL EXHAUST SYSTEMS
CATBACK SYSTEMS
MUFFLERS
EXHAUST TIPS
COMPONENTS & ACCESSORIES
HEADER & COLLECTOR GASKETS
FOOTNOTES
PHOTO GALLERY
PART # TO PAGE INDEX
WARRANTY

COMPONENTS & ACCESSORIES

FLANGE KITS, TUBING & U-BENDS

SUPER COMPETITION COMPONENTS & ACCESSORIES

FLANGE KITS WITHOUT STUBS

We offer a complete line of "hard to find" specialty header flanges. If you don't see it listed here, call our tech line (270) 781-9741 for possible new applications. Flange kits come with gaskets, bolts and polished stainless steel NHRA contingency header I.D. tags.

PART NO.	APPLICATION	PORT SHAPE	PRIMARY TUBE SIZE O.D. (In.)
11890HKR	Chevy Small Block - Outer Flange	Round	1 7/8, 2
11891HKR	Chevy Small Block - Inner Flange	SAP	N/A
11808HKR*	Chevy Small Block - Inner Flange 3/8" Aluminum	SAP	N/A
11809HKR*	Chevy Small Block - Inner Flange 1/2" Aluminum	SAP	N/A
11810HKR	Chevy Small Block - Buick/Dart Head	Round	1 7/8, 2
11832HKR	Chevy Small Block 18" V-8	Round	1 7/8, 2
11833HKR	Chevy Small Block 18" V-8 Outer	Round	2 1/8, 2 1/4
11834HKR	Chevy Small Block 18" V-8 Inner	SAP	N/A
11822HKR	Chevy 262-283-327-350-400	Square	1 3/4
11887HKR	Brodix Spreadport Flange	D-Port	1 7/8, 2
11888HKR	LS1	SAP	1 5/8, 1 3/4
11828HKR	Chevy 396-454	Round	2, 2 1/8
11829HKR	Chevy 396-454	Round	2 1/4
11831HKR	Chevy 396-454	Round	2 3/8
11892HKR	MoPar W2 Outer Flange	Round	2
11893HKR	MoPar W2 Inner Flange	SAP	N/A
11858HKR	MoPar Hemi 426	Square	2, 2 1/8
11859HKR	MoPar Hemi 426	Square	2 1/4
11857HKR	MoPar KB	Round	2 1/2
11851HKR	MoPar Anderson/Dart	Square	2 1/2
11841HKR	Pontiac 400-455 Ram Air II/IV, SD, HO & Edelbrock Performer RPM	Round	2
11863HKR	Ford SVO/351 Cleveland	Round	2 1/4
11866HKR	Ford 429-460	Oval	1 7/8, 2, 2 1/8
11870HKR	302, 351W TFS Early and TFS Twisted Wedge Race Head - Inner flange	SAP	N/A
11871HKR	302, 351W TFS Early and TFS Twisted Wedge Race Head - Outer flange	Round	1 3/4
11872HKR	302, 351W Stock, Holley, GT40, J302, Edelbrock, and TFS Street head - Inner flange	SAP	N/A
11873HKR	302, 351W Stock, Holley, GT40, J302, Edelbrock, and TFS Street head - Outer flange	Round	1 3/4

* These 3/8" and 1/2" thick lightweight aluminum header flange plates are designed to simplify the task of matching exhaust ports to large tube dual flange headers.

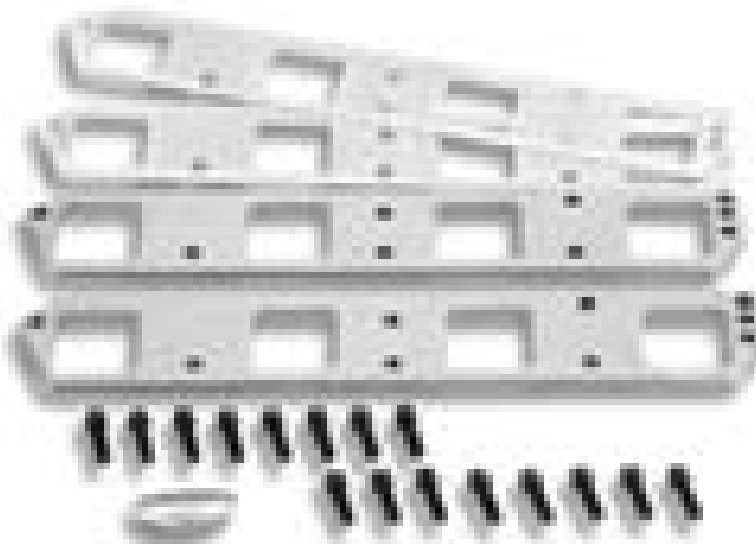

#11859HKR



SUPER COMPETITION COMPONENTS & ACCESSORIES

STRAIGHT TUBING - 5' Length

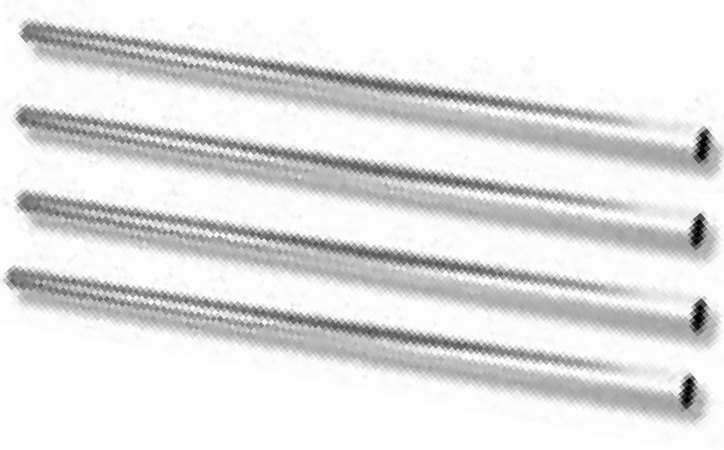

MILD STEEL

Part No.	Gauge Diameter	O.D. (in.)
15450HKR	18	2 ¹ / ₈
15500HKR	18	2 ¹ / ₄
15700HKR	18	3

STAINLESS STEEL

Part No.	Gauge Diameter	O.D. (in.)
35600HKR	18	2 ¹ / ₂

180° MANDREL U-BENDS MILD STEEL



TUBE SIZE

PART NO.	GAUGE	O.D. (in.)	RADIUS (in.)	LEG A (in.)	LEG B (in.)
12200HKR	18	1 ¹ / ₂	6	12	12
12210HKR	18	1 ⁵ / ₈	6	12	12
12220HKR	18	1 ³ / ₄	6	12	12
12230HKR	18	1 ⁷ / ₈	6	12	12
12240HKR	18	2	6	12	12
12250HKR	18	2 ¹ / ₈	6	12	12
12260HKR	18	2 ¹ / ₄	6	12	12
12270HKR	18	2 ¹ / ₂	5	12	12
12280HKR	18	3	6	6	6
12285HKR	18	3 ¹ / ₂	7	6	6
12310HKR	16	4	7 ¹ / ₂	6	6
12311HKR	16	1 ⁵ / ₈	6	12	12
12320HKR	16	1 ³ / ₄	6	12	12
12330HKR	16	1 ⁷ / ₈	6	12	12
12340HKR	16	2	6	12	12
12360HKR	16	2 ¹ / ₄	6	12	12
12380HKR	16	3	6	6	6
12385HKR	16	3 ¹ / ₂	7	6	6

- STREET FORCE HEADERS
- CAMARO/FIBERD LSI HEADERS & Y-PIPE
- COMPETITION HEADERS
- MUSTANG GT EXHAUST SYSTEM
- SUPER COMPETITION HEADERS
- RACE HEADERS
- COMPETITION & SUPER COMP EXHAUST KITS
- DIESEL EXHAUST SYSTEMS
- CATBACK SYSTEMS
- MUFFLERS
- EXHAUST TIPS
- COMPONENTS & ACCESSORIES**
- HEADER & COLLECTOR GASKETS
- FOOTNOTES
- PHOTO GALLERY
- PART # TO PAGE INDEX
- WARRANTY

STREET FORCE HEADERS
CAMARO/FIREBIRD LS1 HEADERS & Y-PIPE
COMPETITION HEADERS
MUSTANG GT EXHAUST SYSTEM
SUPER COMPETITION HEADERS
RACE HEADERS
COMPETITION & SUPER COMP EXHAUST KITS
DIESEL EXHAUST SYSTEMS
CATBACK SYSTEMS
MUFFLERS
EXHAUST TIPS
COMPONENTS & ACCESSORIES
HEADER & COLLECTOR GASKETS
FOOTNOTES
PHOTO GALLERY
PART # TO PAGE INDEX
WARRANTY

COMPONENTS & ACCESSORIES

J-BENDS, BOLTS & COLLECTOR RING KITS



SUPER COMPETITION COMPONENTS & ACCESSORIES

180° MANDREL J-BENDS

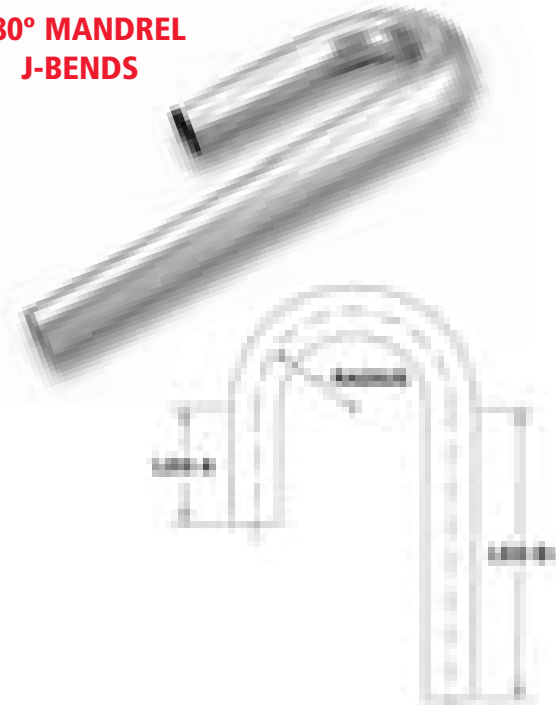

ALUMINIZED STEEL

PART NO.	TUBE SIZE O.D. (in.)	RADIUS (in.)	LEG A (in.)	LEG B (in.)	Wall thickness (in.)
21390HKR	2 1/4	3 1/2	6	15	.060
21397HKR	2 1/2	4	6	15	.060
21380HKR	3	4	6	15	.060

STAINLESS STEEL (300 Series)

PART NO.	TUBE SIZE O.D. (in.)	RADIUS (in.)	LEG A (in.)	LEG B (in.)	Wall thickness (in.)
32540HKR	1 5/8	2 1/2	6	15	.049
32541HKR	1 5/8	2	6	15	.049
32550HKR	1 3/4	2 1/2	6	15	.049
32551HKR	1 3/4	2	6	15	.049
32560HKR	1 7/8	3	6	15	.049
32561HKR	1 7/8	2 1/2	6	15	.049
32570HKR	2	3	6	15	.049
32571HKR	2	4	6	15	.049
32580HKR	2 1/8	3	6	15	.049
32590HKR	2 1/4	3 1/2	6	15	.049
32597HKR	2 1/2	4	6	15	.049
32598HKR	2 1/2	5	6	15	.049

MILD STEEL

PART NO.	GAUGE	TUBE SIZE O.D. (in.)	RADIUS (in.)	LEG A (in.)	LEG B (in.)
12520HKR	18	1 3/8	2 1/2	6	15
12521HKR	18	1 3/8	2	6	15
12525HKR	18	1 1/2	2	6	15
12325HKR	16	1 1/2	2	6	15
12333HKR	16	1 1/2	2 1/2	6	15
12530HKR	18	1 1/2	2 1/2	6	15
12331HKR	16	1 1/2	3	6	15
12532HKR	18	1 1/2	4	6	15
12536HKR	18	1 5/8	2	6	15
12336HKR	16	1 5/8	2	6	15
12538HKR	18	1 5/8	2 1/4	6	15
12540HKR	18	1 5/8	2 1/2	6	15
12341HKR	16	1 5/8	2 1/2	6	15
12542HKR	18	1 5/8	4	6	15
12342HKR	16	1 5/8	4	6	15
12551HKR	18	1 3/4	2	6	15
12550HKR	18	1 3/4	2 1/2	6	15
12351HKR	16	1 3/4	2	6	15
12350HKR	16	1 3/4	2 1/2	6	15
12553HKR	18	1 3/4	3	6	15
12353HKR	16	1 3/4	3	6	15
12552HKR	18	1 3/4	4	6	15
12352HKR	16	1 3/4	4	6	15
12558HKR	18	1 7/8	2 1/2	6	15
12358HKR	16	1 7/8	2 1/2	6	15
12560HKR	18	1 7/8	3	6	15
12361HKR	16	1 7/8	3	6	15
12570HKR	18	2	3	6	15
12370HKR	16	2	3	6	15
12574HKR	18	2	3 1/2	6	15
12572HKR	18	2	4	6	15
12372HKR	16	2	4	6	15
12580HKR	18	2 1/8	3	6	15
12582HKR	18	2 1/8	4	6	15
12590HKR	18	2 1/4	3 1/2	6	15
12390HKR	16	2 1/4	3 1/2	6	15
12592HKR	18	2 1/4	4	6	15
12596HKR	18	2 3/8	3 1/2	6	15
12396HKR	16	2 3/8	3 1/2	6	15
12594HKR	18	2 1/2	5	6	15
12597HKR	18	2 1/2	4	6	15
12397HKR	16	2 1/2	4	6	15
12598HKR	18	2 5/8	4	6	15
12399HKR	16	3	4	6	15
12599HKR	18	3	4	6	15



SUPER COMPETITION COMPONENTS & ACCESSORIES

HEADER BOLTS

Hooker now offers popular sized grade 5 black oxide 6 point header bolts.

#10984HKR

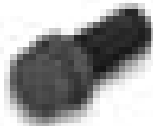

PART NO.	SIZE (in.)	QUANTITY
10981HKR	3/8 - 16 X 3/4	100
10983HKR	3/8 - 16 X 3/4 COUNTER SUNK	12
10984HKR	3/8 - 16 X 1	16

430 GRADE STAINLESS STEEL, OEM STYLE MUFFLER CLAMP



PART NO.	SIZE (IN.)	QUANTITY
41160HKR	2 1/4 to 2 1/2 I.D. X 1 1/4 Wide	1 each

ALIGNMENT WELD SLEEVE

Our "Alignment Weld Sleeve" allows the fabricator to align, hold and weld two pieces of mild steel tube without help. Because no rod is needed, the welder has a free hand. The "Alignment Sleeve" assures a perfectly aligned joint with no weld slag inside to reduce the tube diameter and restrict air flow. Perfect alignment and just the right amount of welding material results in a very professional looking weld. Weld Sleeves are packaged 20 sleeves per bag.

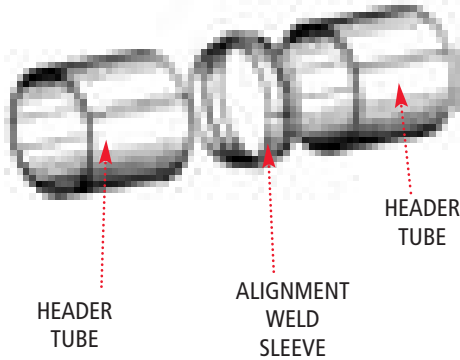

PART NO.	TUBE SIZE O.D. (IN.)
12101HKR	1 1/2-1 5/8
12102HKR	1 3/4
12103HKR	1 7/8
12104HKR	2
12105HKR	2 1/8

COLLECTOR RING KITS

Hooker Collector Rings enable the header builder to adapt Hooker collector extensions or reducers to the basic collector. The kit includes two 3-bolt rings, matching gaskets and six bolts.



#11430HKR

PART NO.	TO FIT TUBE DIAMETER (O.D. IN.)
11425HKR	2 1/2
11430HKR	3
11435HKR	3 1/2

#16803HKR



H-PIPE / BALANCE TUBE ASSEMBLY

Hooker's H-Pipe / balance tube assembly will improve low R.P.M. torque as well as help with the control of excessive noise. Made from heavy wall 16 gauge steel tubing, Hooker H-Pipes are finished with a heat cured, high heat resistant, black paint. This assembly comes complete with all necessary parts needed to install with virtually any dual exhaust system and driveline location.

PART NO.	SIZE O.D. (in.)
16803HKR	2 1/2

Tech Line: 270-781-9741

57

STREET FORCE HEADERS
CAMARO/FIBERD LSI HEADERS & Y-PIPE
COMPETITION HEADERS
MUSTANG GT EXHAUST SYSTEM
SUPER COMPETITION HEADERS
RACE HEADERS
COMPETITION & SUPER COMP EXHAUST KITS
DIESEL EXHAUST SYSTEMS
CORBACK SYSTEMS
MUFFLERS
EXHAUST TIPS
COMPONENTS & ACCESSORIES
HEADER & COLLECTOR GASKETS
FOOTNOTES
PHOTO GALLERY
PART # TO PAGE INDEX
WARRANTY

COMPONENTS & ACCESSORIES

SLIP-ON & FORMED COLLECTORS



- STREET FORCE HEADERS
- CAMARO/FIREBIRD LS1 HEADERS & Y-PIPE
- COMPETITION HEADERS
- MUSTANG GT EXHAUST SYSTEM
- SUPER COMPETITION HEADERS
- RACE HEADERS
- COMPETITION & SUPER COMP EXHAUST KITS
- DIESEL EXHAUST SYSTEMS
- CATBACK SYSTEMS
- MUFFLERS
- EXHAUST TIPS
- COMPONENTS & ACCESSORIES
- HEADER & COLLECTOR GASKETS
- FOOTNOTES
- PHOTO GALLERY
- PART # TO PAGE INDEX
- WARRANTY

SUPER COMPETITION COMPONENTS & ACCESSORIES

CLASSIC SLIP-ON 12" COLLECTORS

Hooker Classic slip-on collectors feature heli-arc construction with unique long transition for better flow. Our precision formed collector stubs are constructed parallel, making slip-on installation easy.

Sold as pairs with 8 locking tabs and all required bolts and nuts.



#11730HKR

4 INTO 1

PART NO.	PRIMARY TUBE SIZE	COLLECTOR DIA. (in)
11730HKR	1 ³ / ₄	3
11742HKR	1 ⁷ / ₈	3 ¹ / ₂
11752HKR	2	3 ¹ / ₂
11764HKR	2	4
11760HKR	2 ¹ / ₈	3 ¹ / ₂
11762HKR	2 ¹ / ₈	4
11770HKR	2 ¹ / ₄	4
11701HKR	2 ³ / ₈	4 ¹ / ₂
11702HKR	2 ³ / ₈	5



"Hooker's power, quality and availability make it easy for me to focus on winning."

- Kevin Helms, 3-Time Consecutive NHRA Stock Eliminator Champion



SUPER COMPETITION COMPONENTS & ACCESSORIES

SLIP-ON 12" POWER SPEAR COLLECTORS

Our Power Spear Collector primary tubes join as they transition into the collector to form a spear. This eliminates sharp edges and voids to reduce turbulence and allows more precise management of the sound pressure waves (tuning) and improves aerodynamic flow.

These 4 into 1 collectors are made from the lightest materials possible; a pair of 1 7/8" x 3 1/2" weigh only 5 lbs. 4 ozs. Sold in pairs only.

#14770HKR



PART NO.	4 INTO 1	
	PRIMARY TUBE SIZE	COLLECTOR DIA. (in.)
14730HKR	1 3/4	3
14743HKR	1 7/8	3 1/4
14742HKR	1 7/8	3 1/2
14752HKR	2	3 1/2
14760HKR	2 1/8	3 1/2
14762HKR	2 1/8	4
14770HKR	2 1/4	4
14705HKR	2 3/8	4
14701HKR	2 3/8	4 1/2
14703HKR	2 1/2	4 1/2
14704HKR	2 1/2	5

HOOKER'S POWER SPEAR™

collector manages exhaust pulses, broadens torque curve and maintains high exhaust gas velocity.

FORMED 10" COLLECTORS

Hooker Formed Collectors incorporate unique long transition to provide better flow. Sold in pairs only.

#11570HKR



#31522HKR

3 INTO 1 MILD STEEL COLLECTORS

PART NO.	PRIMARY TUBE SIZE	COLLECTOR DIA. (in.)
11511HKR	1 1/2	2 1/2

4 INTO 1 MILD STEEL COLLECTORS

PART NO.	PRIMARY TUBE SIZE	COLLECTOR DIA. (in.)
11510HKR	1 1/2	2 1/2
11515HKR	1 5/8	2 1/2
11522HKR	1 5/8	3
11530HKR	1 3/4	3
11540HKR	1 7/8	3
11542HKR	1 7/8	3 1/2
11552HKR	2	3 1/2
11560HKR	2 1/8	3 1/2
11562HKR	2 1/8	4
11570HKR	2 1/4	4

STAINLESS STEEL COLLECTORS

PART NO.	PRIMARY TUBE SIZE	COLLECTOR DIA. (in.)
31522HKR	1 5/8	3
31530HKR	1 3/4	3
31552HKR	2	3 1/2

Tech Line: 270-781-9741

59

STREET FORCE HEADERS
CAMARO/FIBERGLASS HEADERS & Y-PIPE
COMPETITION HEADERS
MUSTANG GT EXHAUST SYSTEM
SUPER COMPETITION HEADERS
RACE HEADERS
COMPETITION & SUPER COMP EXHAUST KITS
DIESEL EXHAUST SYSTEMS
CATBACK SYSTEMS
MUFFLERS
EXHAUST TIPS
COMPONENTS & ACCESSORIES
HEADER & COLLECTOR GASKETS
FOOTNOTES
PHOTO GALLERY
PART # TO PAGE INDEX
WARRANTY

STREET FORCE HEADERS
 CAMARO/ FIREBIRD LS1 HEADERS & Y-PIPE
 COMPETITION HEADERS
 MUSTANG GT EXHAUST SYSTEM
 SUPER COMPETITION HEADERS
 RACE HEADERS
 COMPETITION & SUPER COMP EXHAUST KITS
 DIESEL EXHAUST SYSTEMS
 CATBACK SYSTEMS
 MUFFLERS
 EXHAUST TIPS
 COMPONENTS & ACCESSORIES
 HEADER & COLLECTOR GASKETS
 FOOTNOTES
 PHOTO GALLERY
 PART # TO PAGE INDEX
 WARRANTY

COMPONENTS & ACCESSORIES

EXTENSIONS, MOUNTING BRACKETS & REDUCERS

SUPER COMPETITION COMPONENTS & ACCESSORIES

BOLT-ON COLLECTOR EXTENSIONS

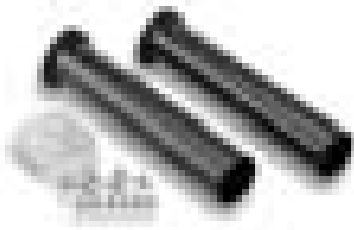

#11230HKR

Designed for use with 3-bolt collector rings, these 18" long extensions enable the racer to adjust his torque curve to suit track conditions. The kit contains two extensions, matched gas-kets, and six nuts and bolts.

Part No.	Collector Dia. O.D. (in.)
11230HKR	3
11235HKR	3 1/2

18" SLIP-ON COLLECTOR EXTENSIONS

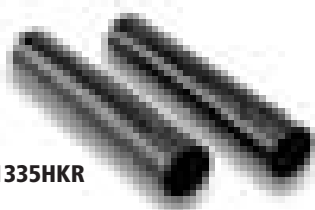

#11335HKR

Designed for use on headers with no collector rings, Hooker's exclusive hydraulic expansion process makes slip-on installation easy. Comes with 8 locking tabs and all required nuts and bolts.

Part No.	Collector Dia. O.D. (in.)
11330HKR	3
11335HKR	3 1/2
11340HKR	4

SLIP-ON COLLECTOR EXTENSION TURNOUTS

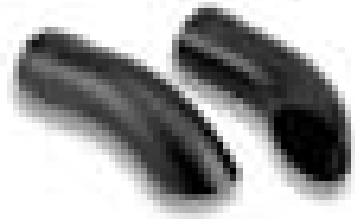

Now circle track and drag race enthusiasts have a way to direct exhaust gas fumes away from the car. Hooker's 3", 3 1/2" and 4" slip-on collector extension turnouts are the answer. Each kit contains two extensions 12" in length, with 8 locking tabs and all required bolts and nuts.

Part No.	Collector Dia. O.D. (in.)
11331HKR	3
11336HKR	3 1/2
11338HKR	4

MOUNTING BRACKETS

Hooker offers all necessary brackets to accommodate Hooker Headers to the stock power steering, air conditioning and alternator / generators that mount directly to the stock manifolds. Check the footnotes carefully for applications.

#10925HKR



GM Alternator Bracket Left Side (Driver side)

10927HKR
10917HKR (Chrome)

GM Alternator Bracket Right Side (Passenger side)

10922HKR
10912HKR (Chrome)

GM AC Bracket
10925HKR/10926HKR

Ford Power Steering Bracket
10961HKR

Adaptors for P/Ns 10922HKR and 10927HKR, for early Chevy applications.

10928HKR
10918HKR (Chrome)

#10912HKR

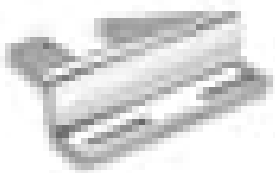

#10917HKR



#10961HKR

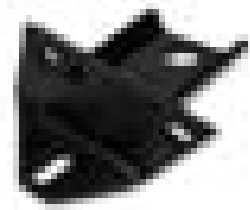

#10918HKR





SUPER COMPETITION COMPONENTS & ACCESSORIES

HOOKER REDUCERS

Just pick the reducer size that matches the diameter of the header collector. Bolt it to the collector ring, and weld on the tailpipe. If you have a header without the collector ring, use Hooker slip-on reducers. They're sized to slip over the collector and weld to the exhaust pipe.

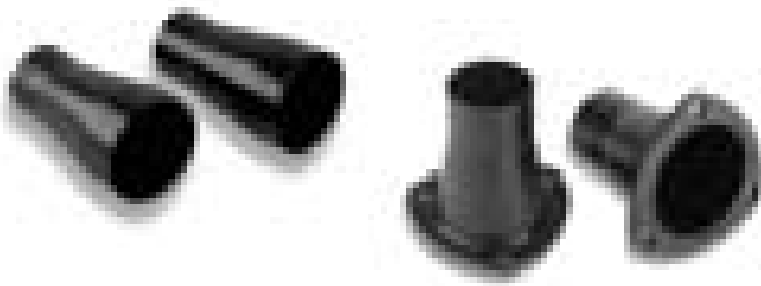

For custom or do-it-yourself fabricators building headers for computer controlled cars or trucks using an oxygen sensor. Our universal weld-on fitting works with most OEM and aftermarket sensors using a metric 18 thread size.

OXYGEN SENSOR FITTING

PART NO.	DESCRIPTION O.D.
10979HKR	Universal Weld-on fitting
10980HKR	O ₂ Sensor plug

OXYGEN SENSOR REDUCERS

PART NO.	DESCRIPTION (O.D.)
11045HKR	2 1/2" Collector to 2" Tailpipe (bolt-on) pr.
11046HKR	3" Collector to 2 1/8" Tailpipe (bolt-on) pr.
11147HKR	3" Collector to 2 1/2" Tailpipe w/ O ₂ bung

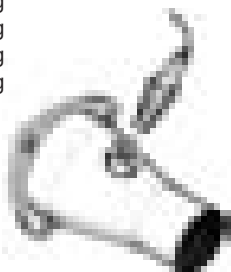

Part No. Description O.D. SLIP-ON REDUCERS

11125HKR	2 1/2" Collector to 2" Tailpipe pr.
11130HKR	3" Collector to 2 1/8" Tailpipe pr
11136HKR	3 1/2" Collector to 3" Tailpipe
11138HKR	4" Collector to 3" Tailpipe
11139HKR	4" Collector to 3 1/2" Tailpipe
11143HKR	4 1/2" Collector to 4" Tailpipe
11148HKR	3" Collector to 2 1/2" Tailpipe

3 BOLT FLANGED REDUCERS

11024HKR	2 1/2" Collector 2" Tailpipe ea.
11025HKR	2 1/2" Collector to 2" Tailpipe pr.
11026HKR	2 1/2" Collector to 2 1/2" Tailpipe
11030HKR	3" Collector to 2 1/8" Tailpipe
11032HKR	3" Collector to 3" Tailpipe
11040HKR	3" Collector to 2 1/2" Tailpipe
110401HKR	3" Collector to 2 1/2" Tailpipe (ceramic finish)
11035HKR	3 1/2" Collector to 2 1/2" Tailpipe
110351HKR	3 1/2" Collector to 2 1/2" Tailpipe (ceramic finish)
11036HKR	3 1/2" Collector to 3" Tailpipe
11037HKR	3 1/2" Collector to 3 1/2" Tailpipe

SLIP-ON COLLECTOR LOCKING TABS

Part No.	Description
41521HKR	Includes 4 tabs, bolts, washers and nuts

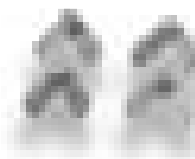

RACING CUT-A-WAYS

The Hooker Racing Cut-A-Way allows you to use your exhaust system for everyday use and unleash your vehicles true power on race day with the turn of a wrench.

#11190HKR



Part No.	Quantity	Comments
11190HKR	1	Two must be ordered for dual exhaust systems. Fits all popular exhaust sizes (2" - 3.5").
<ul style="list-style-type: none"> Can be plumbed into your current exhaust system or installed directly to your header collectors with purchase of Hooker Collector ring kits: <ul style="list-style-type: none"> 11425HKR - 2 1/2" Collector 11430HKR - 3" Collector 11435HKR - 3 1/2" Collector Block plate and ring surface is machined so that no gaskets are needed. Removable / replaceable studs make changing damaged studs easy. Chrome acorn nuts and studs require <u>no special tools</u> and allow a one handed removal of the machined block plate. Coated in high heat resistant black paint. 		

Tech Line: 270-781-9741

61

STREET FORCE HEADERS
CAMARO/FIBERD LSI HEADERS & Y-PIPE
COMPETITION HEADERS
MUSTANG GT EXHAUST SYSTEM
SUPER COMPETITION HEADERS
RACE HEADERS
COMPETITION & SUPER COMP EXHAUST KITS
DIESEL EXHAUST SYSTEMS
CARBURETOR SYSTEMS
MUFFLERS
EXHAUST TIPS
COMPONENTS & ACCESSORIES
HEADER & COLLECTOR GASKETS
FOOTNOTES
PHOTO GALLERY
PART # TO PAGE INDEX
WARRANTY

STREET FORCE HEADERS
CAMARO/ FIREBIRD LS1 HEADERS & Y-PIPE
COMPETITION HEADERS
MUSTANG GT EXHAUST SYSTEM
SUPER COMPETITION HEADERS
RACE HEADERS
COMPETITION & SUPER COMP EXHAUST KITS
DIESEL EXHAUST SYSTEMS
CATBACK SYSTEMS
MUFFLERS
EXHAUST TIPS
COMPONENTS & ACCESSORIES
HEADER & COLLECTOR GASKETS
FOOTNOTES
PHOTO GALLERY
PART # TO PAGE INDEX
WARRANTY

COMPONENTS & ACCESSORIES

HEADER & COLLECTOR GASKETS

SUPER COMPETITION COMPONENTS & ACCESSORIES

DESCRIPTION / ENGINE	PART #
AMERICAN MOTORS	
8 cyl - 290-401	10801HKR
6 cyl - 199-258	10802HKR
BUICK	
8 cyl - 350	10804HKR
8 cyl - 400-455	10807HKR
CHEVROLET / GMC	
Passenger Car/Truck (SAP) - 265-400	10808HKR
Passenger Car - 350 LS-1	10878HKR
Race Car - Double Flange - 265-400	10812HKR
Street Rod/Universal - stylized 265-400	10891HKR
Passenger Car - 348-409	10860HKR
Passenger Car/Truck (SAP) - 396-454	10809HKR
Race Car - Round Port - 396-454	10810HKR
V8 Olds Diesel Truck	10846HKR
DATSUN / NISSAN	
6 cyl 240-260Z	10852HKR
FORD / MERCURY	
4 cyl Fiesta	10829HKR
4 cyl 1600 cc	10829HKR
V-6 2800 cc	10828HKR
6 cyl - 170-250	10827HKR
6 cyl - 240-300 1965-82 and later	10819HKR
4.6L 2V	10883HKR
4.6L 3V	10887HKR
4.6L 4V	10886HKR
8cyl - 302-351 Windsor	10820HKR
Double Flange 302-351 Windsor/TFS	10861HKR
Cleveland - 4 Barrel Heads (4V)(Boss)-302-351 1 ⁷ / ₈ "	10822HKR
Cleveland - 4 Barrel Heads (4V)(Boss)-302-351 1 ³ / ₄ "	10877HKR
Passenger Cars - 352-428	10823HKR
Trucks - 352-390	10825HKR
Trucks/Vans - 460 F.I. Head	10882HKR
INTERNATIONAL	
Pickup Trucks - 304-392	10803HKR
MOPAR - DODGE / PLYMOUTH	
Passenger Car - 318-360	10836HKR
Race Car - Double Flange - 318-360 (W-2 heads)	10845HKR
Passenger Car/Truck 383-440	10838HKR
OLDSMOBILE	
260-455	10846HKR
PONTIAC	
SAP 326-455	10848HKR
Round Port - 400-455	10849HKR
TOYOTA	
4 cyl Hemi - 1600/1800 cc	10863HKR

Collector Gaskets

Collector Size	Part #
2 ¹ / ₂ "	10871HKR
3"	10872HKR
3 ¹ / ₂ "	10873HKR

Header Gaskets

Hooker's precision-matched Super Competition header gaskets provide a sure fit and unmatched exhaust sealing. This OEM quality gasket is constructed of a thick (.070") laminated, graphite impregnated substrate. The substrate combined with a perforated aluminum core provides superior grip and adhesion. This construction also contributes to exact fit compliance between the cylinder head and header flange, offering superior sealing properties during extreme temperature and operating conditions.

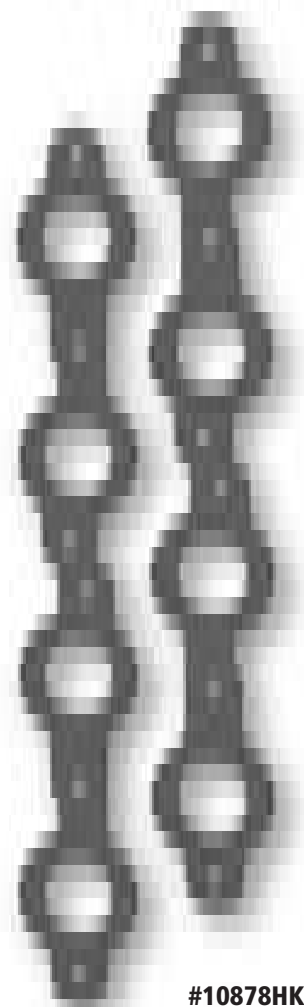

#10878HKR



HOOKER® PRESSURE MASTER GASKETS & SEALS WITH EARL'S® SEALING TECHNOLOGY



Pressure Master™

Sealing Systems utilize an aluminum retainer that captures and controls compression of our exclusive graphite foil inner seal for unsurpassed sealing. Unaffected by thermal cycling, each joint can be torqued to optimum pre-load during installation, and there's no residue to clean up after installation.

CHEVY SMALL BLOCK 265-400

29D03BERL	Header Seals with 1.50" x 1.50" ports (pair)
29D03B1ERL	replacement insert set (1.50" x 1.50" ports)
29DA3BERL	Header Seals with D-Port LT-1 ports (pair)
29D03B3ERL	replacement insert set (D-Port LT-1 ports)
29D03B4ERL	Header Seals with 1.36" x 1.36" ports (pair)
29D03B5ERL	replacement insert set (1.36" x 1.36" ports)
29DC3BERL	Header Seals with Round 1.59" Dia. ports (pair)
29D03B2ERL	replacement insert set (Round 1.59" Dia. ports)
29DD3BERL	Header Seals with D-Port 1.50" x 1.50" ports (pair)
29D03B6ERL	replacement insert set (D-Port 1.55" x 1.63" ports)
29DE3BERL	Header Seals with uncut centers (pair)
29D03B2ERL	replacement insert set (uncut centers)

CHEVY BIG BLOCK 396-502

29D04BERL	Header Seals for Chevy with 1.50" x 1.50" ports (pair)
29D04B1ERL	replacement insert set (1.50" x 1.50" ports)
29D04B2ERL	replacement insert set (uncut centers)

FORD SMALL BLOCK 289-302-351W

29D03AERL	Header Seals for Ford 289-302-351W (pair) (Except Boss)
29D03A1ERL	replacement insert set (standard)
29D03A2ERL	replacement insert set (uncut centers)

FORD BIG BLOCK 429-460

29D04AERL	Header Seals for Ford 429-460 (pair)
29D04A1ERL	replacement insert set (standard)
29D04A2ERL	replacement insert set (uncut centers)

#29DB3BERL

COLLECTOR SEALS

Pressure Master™ Seals, designed and manufactured for Hooker using Earl's sealing technology by Parker Hannifin Corporation, are the first High Performance Seals developed to solve automotive sealing problems using Aerospace Technology.

COLLECTOR SEALS

29D15ZERL	3 Bolt 2-1/2" Dia. (pair)
29D10ZERL	3 Bolt 3" Dia. (pair)
29D20ZERL	3 Bolt 3-1/2" Dia. (pair)

REPLACEMENT INSERTS

29D15Z1ERL	3 Bolt 2-1/2" Dia. (pair)
29D10Z1ERL	3 Bolt 3" Dia. (pair)
29D20Z1ERL	3 Bolt 3-1/2" Dia. (pair)

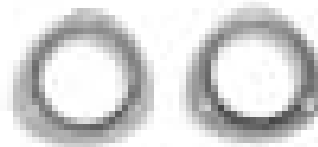

#29D15ZERL

Tech Line: 270-781-9741

63

STREET FORCE HEADERS
CAMARO/FIBERGLASS HEADERS & Y-PIPE
COMPETITION HEADERS
MUSTANG GT EXHAUST SYSTEM
SUPER COMPETITION HEADERS
RACE HEADERS
COMPETITION & SUPER COMP EXHAUST KITS
DIESEL EXHAUST SYSTEMS
CATBACK SYSTEMS
MUFFLERS
EXHAUST TIPS
COMPONENTS & ACCESSORIES
HEADER & COLLECTOR GASKETS
FOOTNOTES
PHOTO GALLERY
PART # TO PAGE INDEX
WARRANTY

STREET FORCE HEADERS
CAMARO/ FIREBIRD LS1 HEADERS & Y-PIPE
COMPETITION HEADERS
MUSTANG GT EXHAUST SYSTEM
SUPER COMPETITION HEADERS
RACE HEADERS
COMPETITION & SUPER COMP EXHAUST KITS
DIESEL EXHAUST SYSTEMS
CATBACK SYSTEMS
MUFFLERS
EXHAUST TIPS
COMPONENTS & ACCESSORIES
HEADER & COLLECTOR GASKETS
FOOTNOTES
PHOTO GALLERY
PART # TO PAGE INDEX
WARRANTY

COMPONENTS & ACCESSORIES

MUSTANG CAR BARS, Q&A

SUPER COMPETITION LATE MODEL MUSTANG CAR BARS

Hooker is more than just high performance. Once you get your Mustang running like you want it, you've got to make it look as good as it runs.

Hooker car bars are constructed of 2 1/4" O.D. .125" wall steel tubing with 3/16" attaching plates. The four point design helps stiffen the uni-body chassis as well as provide good looks and improved safety without restricting rear seat room.

Available in show quality chrome or high gloss black powdercoat. Most bars can be shipped through UPS.

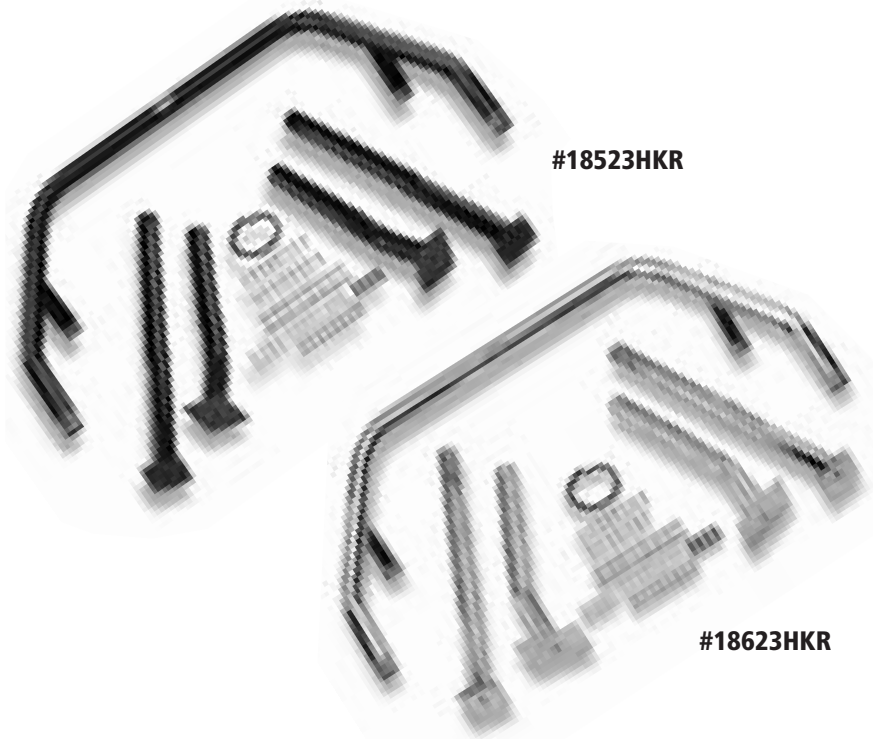

YEARS	MODEL	BLACK	CHROME
79-93	Hard Top		18615HKR
83-93	Convertible.	18517HKR	18617HKR
94-98	Convertible. & Hard Top	18523HKR	18623HKR

Hooker Car Bars are:

- 1) not a replacement for responsible driving, and
- 2) are not intended for competition use.

CAUTION: The end user of Hooker Car Bars assumes the risk of damage or injury resulting from their use.





What is the difference between your Super Competition and Competition Headers?

Hooker Super Competition headers are built from lightweight 18 gauge mild steel tubing with "tuned" lengths for maximum performance. Super Competition headers also use long transition collectors for reduced back-pressure and increased exhaust flow. 5/16" machined flanges with welded O-rings make for a perfect sealing surface.

- Super Competition headers come with many different options in tube diameter and length for a particular application. Super Competition headers are the "World's Best Header". Competition Headers are built from durable 16 gauge mild steel tubing. Competition headers use long transition collectors for reduced back-pressure and increased exhaust flow. 5/16" machined flanges with welded O-rings make for a perfect sealing surface.
- By removing some of the constraints on our designers when they design a Super Competition header, we can produce a Competition header, for easier installation and a lower price. The Comp header will weigh slightly more than the Super Competition header but will last slightly longer under extreme climatic conditions. Competition headers are the "World's Second Best Header". We will sometimes spend two to three times more just to make a Super Competition Header work only five to ten percent better.

How thick are your flanges and are thicker flanges better?

Not necessarily. The key to a good flange is to seal at the exhaust port locations. Hooker flanges are machined (using a milling process) to a surface flatness of + or - .0025 between the bolt holes. This process guarantees a proper seal at the port locations virtually eliminating flange leaks. Other header manufacturers simply run their flanges over a belt sander or body grinder.

Hooker flanges are 5/16" (except on some unique applications). This is heavy enough to keep the header integrity, but is pliable enough to seal each exhaust port. This helps compensate for variables in the head surface. Overly thick flanges are not as pliable and tend to have leaks. Hooker flanges seal the first time every time.

Will your headers fit with aftermarket cylinder heads?

Most aftermarket cylinder head manufacturers offer stock replacement and racing heads. Hooker headers will accommodate the stock replacement head in most cases. If the aftermarket head uses an angle plug configuration, the Hooker header for that application will have footnote 62 which says that it will fit with angle plug heads. If your aftermarket head is a straight plug stock replacement, the Hooker header for your application will fit.

Most aftermarket racing heads have raised exhaust ports. Most Hooker headers are designed around the stock port height and will not accommodate the raised port heads. Hooker will produce headers for raised port heads when that particular head becomes the standard (for example: Super Competition header #62225HKR fits 1979-93 Mustangs with the popular TFS Twisted Wedge Race Head).

Will your headers fit with my other performance equipment?

In most cases, Hooker headers are developed around the stock engine location using stock equipment. Aftermarket products, such as rigid motor mounts locate the motor in a different location causing possible fitment problems. Other performance products, such as kickout style oil pans and performance "mini starters", can interfere with some header applications. Check the listing (read the footnotes) in our full line catalog or contact our tech department at (270)781-9741.

Do you have a Warranty?

Yes, Hooker performance exhaust products are covered under a 90 day warranty. See the last page of this catalog for complete warranty and contact information.

What tube size do I need and is bigger better?

Header primary tube sizes vary on many factors: engine combination, transmission type, gear ratio and intended use of the vehicle. For example a truck header will be designed using longer length and smaller diameter primary tubes to enhance low to mid-range performance, where a header for a Pro Stock race car will have larger primary tubes and large collectors for the highest flow available.

Bigger generally is not better when it comes to street driven cars. when you put too large of a header or exhaust on a street driven vehicle, you usually notice a severe drop in low to mid-range performance due to a lack of back-pressure. To combat this issue, Hooker sometimes builds 3 or 4 different headers for a particular application with varying tube and collector sizes.

Should I use exhaust wrap on my Hooker Headers?

If your vehicle is being run on the street or for extended periods of time, you should never wrap headers. Exhaust wraps insulate the exhaust too much and the exhaust temperature is raised to a level that fatigues the header material causing cracks.

If under-the-hood temperatures are an issue, we recommend using Hooker's Metallic Ceramic Thermal Barrier Coating. It is corrosion and heat resistant up to 1600°F. It also reduces under-the-hood temperatures and has a polished high luster finish. Holding exhaust temperatures inside the header increases the exhaust gas velocity producing more horsepower.

You can purchase any Hooker header with our Metallic Ceramic Thermal Barrier Coating by adding a -1 to the end of the part number.

TIP: Breaking in an engine with ceramic coated headers WILL result in damage to the coating and will VOID all warranties. Ceramic coated headers require several heat cycles to fully cure before they will withstand extreme heat. Hooker recommends using cast iron exhaust manifolds or old headers to break in new engines to avoid coating damage. Please call Hooker tech service at 270-781-9741 for additional information regarding ceramic coated exhaust products.

TRIFT F RCE HEADERS
CAMAR / FREEDOM L31 HEADERS & Y-PIPE
C MPELTI N HEADERS
MUSTANG GT EXHAUST SYSTEM
C MPELTI N SUPER N HEADERS
RACE HEADERS
C MPELTI N & SUPER C MPE EXHAUST KITS
DIESEL EXHAUST SYSTEMS
CATERACK SYSTEMS
MUFFLERS
EXHAUST TIPS
C MPE NERTS & ACCESS RIES
HEADER & C LLECT R GASKETS
F TIN TES
PH T GALLERY
PART # T PAGE INDEX
WARRANTY

FOOTNOTES

STREET FORCE
HEADERS

CAMARO/
FIREBIRD LSI
HEADERS &
YPIPE

COMPETITION
HEADERS

MUSTANG GT
EXHAUST
SYSTEM

SUPER
COMPETITION
HEADERS

RACE
HEADERS

COMPETITION
& SUPER COMP
EXHAUST KITS

DIESEL EXHAUST
SYSTEMS

CATBACK
SYSTEMS

MUFFLERS

EXHAUST
TIPS

COMPONENTS
& ACCESSORIES

HEADER &
COLLECTOR
GASKETS

FOOTNOTES

PHOTO
GALLERY

PART #
TO PAGE
INDEX

WARRANTY

- 1) This system uses 2¹/₄" O.D. tubing. We recommend using either the Super Competition Aero Chamber, Maximum Flow or Turbo Mufflers in a 2¹/₄" offset inlet/center outlet configuration. See page 42 for complete muffler information.
- 2) Available with fittings to accommodate air injection manifold. Add a 0 in front of the part number when ordering.
- 3) Factory 4 Wheel Drive.
- 4) Exhaust systems can also be fabricated using either Hooker Super Competition Aero Chamber mufflers, Maximum Flow mufflers, Super Competition turbo mufflers, Competition turbo mufflers or header type Hooker mufflers.
- 5) Not legal for sale or use on vehicles originally equipped with catalytic converters. For racing purposes only.
- 6) Comes with H-pipe/balance tube assembly. For racing purposes only.
- 8) Installation on manual transmission equipped cars requires fabrication of a clutch linkage pivot bracket. Also needed are one stock Pinto clutch cable assembly, one link Ford #D1FZ-2861-AJ and one adjustable clutch rod Ford #DOT2-7521-C.
- 9) Installation requires air conditioning bracket #10925HKR left side or #10926HKR right side. On 1979 and later vehicles with short compressors, use stock bracket.
- 10) Will not fit motors equipped with air injection pump without modification.
- 11) Header designed for 302W engines using the AR SVO aluminum heads.
- 12) Comes with 12" Classic slip-on collectors and 16 formed adjustable header slip tubes plus 18" slip-on collector extensions where applicable. Split Flow or Merged or Merged Slip-On collectors can be ordered separately.
- 13) Special PRO STOCK header for cars equipped with standard steering.
- 14) Installation with manual transmission requires fabrication of a clutch cable bracket.
- 15) Header comes with Metallic Ceramic THERMAL BARRIER COATING.
- 16) This header comes with an adapter flange. The port shape is the same as stock but can be matched to your particular exhaust port configuration.
- 17) Fits all cars equipped with automatic transmissions except 1970 Hornet.
- 18) One tube each side over frame.
- 19) Hooker mufflers #21021HKR (glass pack), #21003HKR (reverse flow design for maximum sound control) or 21046HKR Max Flow sidepipe muffler, slip-in design to be used with 4" sidetubes.
- 20) Will not fit with powerglide.
- 21) Will not fit convertible models.
- 22) Header dual system will not fit Turbo 400 applications.
- 23) This header was designed to be used with the original Chevy II V8 block, bell housing and clutch linkage. Will also fit Chevy II with Lakewood bellhousing #15050HKR. For the transplant or anything other than original Chevy II equipment we recommend #2214HKR OR 2243HKR.
- 24) One tube over frame left side.
- 25) This is a tuned equal length "SHORTY" style header which will bolt directly to the 1986 and later factory exhaust headpipes.
- 26) Will not fit 1973 cars equipped with the 440 engine.
- 27) Two tubes over frame on each side.
- 28) Hooker mufflers #21021HKR (glass pack) or #21002HKR (reverse flow design for maximum sound control) or 21046HKR Max Flow sidepipe muffler, slip-in design to be used with 4" sidetubes.
- 29) Fits 4V heads only.
- 30) One tube over frame right side.
- 31) Without oil cooler.
- 32) Will not fit 71-72 Comet, refer to #6104HKR. 1972 Torino does not require a power steering bracket. Refer to 6110HKR.
- 33) Fits 2V heads only.
- 34) Will not fit 1970 Falcon with either 114" or 117" wheelbase.
- 35) Will accommodate the E.G.R. system only.
- 36) Will accommodate all emission control devices, i.e. E.G.R. and air pump fittings.
- 37) This header cannot be installed by using the stock location side motor mounts. This header requires:
 - 1971-74 installation kit #12601HKR which consists of front and rear motor mounts.
 - 1975-80 front motor mounts #12608HKR.
 - 1976-80 rear mount #12635HKR for Turbo 350, 4-speed or aluminum powerglide installation.
 - All require any 1967-77 Camaro rubber transmission mount which fits your particular transmission.
- 38) Installation with manual transmission requires the fabrication of a clutch cable bracket.
- 39) Header will not accommodate the emission control devices attached to exhaust manifold on 1977 and later vehicles and is recommended for racing purposes only for these models.
- 40) Will not accommodate E.G.R. system and is recommended for racing purposes only for these models.
- 41) This header requires 1958 and later blocks with side motor mounts front and rear frame mounts and firewall modification. This kit will fit Turbo 350, 4-speed or aluminum powerglide transmissions. Will **NOT** fit the Turbo 400. All require any 1967-77 Camaro rubber transmission mount which fits your particular transmission.
- 42) Will not accommodate the 1974 and later E.G.R. system and is recommended for racing purposes only on these models.
- 43) Fits integral head engine only (i.e. intake manifold is part of the head - exhaust manifold bolts to the bottom, not to the side of head).
- 44) Will not fit with C-6 automatic transmissions.
- 45) This part number consists of headers with welded air injection fittings, a hot air kit, an adapter for the OEM EFE activator and Y-pipe for catalytic converter accommodation and all necessary hardware and instruction sheet.
- 46) Cat-Back exhaust system does not fit extended cabs.
- 47) Designed for use with Danchuk style engine mount and rear transmission crossmember. Stock mid mount and ears on frame must be removed.
- 48) Fits 6 speed ZF transmissions and standard 5-speed.
- 49) Will fit Dart Windsor head.
- 50) Will fit dragster and roadster frames **NOT** exceeding 21" in width.
- 51) This Cat-Back exhaust system is supplied with an optional racing H-Pipe/Balance Tube Assembly, for use on racing vehicles only, which replaces the smaller diameter pipes for better performance and the catalytic converters to prevent damage caused by leaded racing fuel. This optional H-Pipe/Balance Tube Assembly is illegal except for racing vehicles which may never be driven upon a highway.
- 52) Steering shaft must be below the exhaust ports. Requires #10922HKR for mounting alternator on the right side.
- 53) Smog version #02452HKR will fit 1969-86 model years only.
- 54) Two tubes over frame right side.
- 55) Manifold dual kit fits 1971-87 only.
- 56) Will not fit EFI engines.
- 57) This is a replacement "SHORTY" style header which will bolt directly to the stock H-pipe headpipes.
- 58) This is a replacement "SHORTY" style header which will bolt directly to the 1994 and later exhaust headpipes.
- 59) This header requires the use of Hooker engine swap front frame mount kit part #12678HKR. Stock transmission crossmember may be utilized.
- 60) Brodix spreadport design.
- 61) This header uses a slip-on collector for ease of installation.
- 62) Will fit heads with factory plug angle.
- 63) This header requires the use of Hooker engine mount kit part #12679HKR. Stock transmission crossmember can be utilized.
- 64) This is a replacement "SHORTY" style header which will bolt directly to the 1986 and later factory exhaust headpipes.
- 65) This header requires frame mount fabrication. Also needed are two Ford motor mounts #D7ZZ-6038B (left side) and one Ford transmission mount #C88ZZ-6068A.
- 66) This is an unequal length "SHORTY" style header which will bolt directly to the stock Mustang exhaust headpipes.
- 67) Header designed for engines equipped with TFS aluminum heads.
- 68) Will not fit Dart Windsor head.
- 69) An H-Pipe/Balance tube assembly is available for this header; part number is listed under dual exhaust system column. This optional H-Pipe/Balance tube assembly is illegal, except for racing vehicles which may never be driven upon a highway.
- 70) Will not fit Chevy Suburban.
- 71) This is a tuned equal length "SHORTY" style header which will bolt directly to the 1994 and later factory exhaust headpipes.
- 72) Will not fit with air conditioning.
- 73) 1990 models require the use of oil pan and pickup from 87-89 models.
- 74) Part #1115HKR includes headers, cross over pipe and turbo exhaust inlet tube with provisions for oxygen sensor. All parts are coated with Hooker's Metallic Ceramic THERMAL BARRIER COATING.
- 75) Header dual exhaust system fits 1975-86 only.
- 76) Installation requires alternator bracket 10927HKR or 10917HKR for driver side or alternator bracket 10922HKR or 10912HKR for passenger side. Alternator adapter 10928HKR or 10918HKR are also required..
- 77) Will not fit 1971-73 Mustang/Cougar with manual transmission.
- 78) This design requires the fabrication of a turbo outlet tube.
- 79) Requires engine setback, rack and pinion steering, will accept stock subframe.
- 80) This header comes with a 1/2" aluminum adapter flange. The port shape is the same as stock but can be matched to your particular exhaust port configuration.
- 81) This header cannot be installed by using the stock location side motor mounts. This header requires:
 - 1971-78 front mount #12603HKR.
 - 1976-80 rear mount #12635HKR for Turbo 350, 4-speed or aluminum powerglide installation.
 - All require any 1967-77 Camaro rubber transmission mount which fits your particular transmission.
- 82) Will not fit cast iron powerglide.
- 83) Installation requires power steering bracket #10961HKR.
- 84) Fenderwell exit.
- 85) Header equipped with smog fittings installed to accommodate factory air pollution control device.
- 86) Header accommodates factory catalytic converter.
- 87) Will not fit models with round port heads.
- 88) Header designed for tube chassis PRO-STOCK style cars with strut front end.
- 89) Will not fit models with rear A/C without modifications to A/C lines.
- 90) See page 37-41 for more information on Hooker exhaust systems.
- 91) Will not fit the station wagons.
- 92) This header is equipped with a fitting to accept the stock oxygen sensor.
- 93) Designed to fit the silent shaft engine.
- 94) This header comes with accommodations for E.G.R., oxygen sensor and air pump (smog tree welded to header).
- 95) Will not fit 1967 Y-block engines.



- 96) The header requires 1958 or later engine blocks and Hooker frame mounts #12606.
 - Use rear mount #12630HKR for the Turbo 350, aluminum powerglide or manual transmission.
 - All require any 1967-77 Camaro rubber transmission mount which fits your particular transmission.
- 97) Installation with manual transmission requires use of bellhousing from 1975-78 Skyhawk, Starfire or '78 Monza. Use stock Vega clutch cable. For heavy duty application use any V8 Monza clutch cable.
- 98) 71-74 engine installation requires use of GM factory parts, frame stand, left #1705321, right #1746350. U-shape bracket, left #1249826, right #1250392, rubber motor mount, left #1250717, right #1250716. Above parts also available from 75-78 Skyhawk, Starfire or 78 Monza.
 - Rear transmission mounts must be fabricated for 71-74 applications.
 - 1975 retain stock crossmember and use Buick V6 rubber transmission mount from 75-78 Skyhawk, Starfire or 78 Monza.
 - 76-79 use rear mount Hooker #12635HKR for Turbo 350, 4-speed or aluminum powerglide installation.
 - All require any 1967-77 Camaro rubber transmission mount which fits your particular transmission.
- 99) Designed for W-2 heads only.
- 100) System includes two Super Competition turbo mufflers #21106HKR and will bolt to the factory four bolt catalytic converter outlet flange.
- 101) Will not fit Club Cab.
- 102) This header requires the fabrication of front and rear frame mounts and firewall modification. This kit will fit Turbo 350, 4-speed or aluminum powerglide transmission. Will NOT fit the Turbo 400 transmission. All require any 1967-77 Camaro rubber transmission mount which fits your particular transmission.
- 103) This header is designed for any front mount that will place the centerline of the crankshaft 6" above the crossmember.
- 104) Fits cross flow "Iron Duke" only.
- 105) See pages 46 & 50 for sidecube mufflers.
- 106) This header requires Hooker frame mounts #12610 and two Chevrolet later model Corvette motor mounts, GM #17980387. Will fit either a turbo 350 or 700 R-4 transmission using the stock 5-10/5-15 crossmember and rubber transmount.
- 107) This header requires fabrication of front frame mounts and also will need 2 Ford motor mounts #D00Z6038G.
- 108) Requires fabrication of transmount for C-4 automatic transmission or Borg-Warner and "Top-Loader" model 4-speed, will also need one Ford transmission mount #D3DZ6068A.
- 109) This header requires use of Advance Adapter or Downey Toyota Swap Kit.
- 110) Two tubes over frame on driver's side and one tube over frame on passenger's side.
- 111) Maximum ground clearance design for cars lowered up to 4 inches.
- 112) Buick supplied the V-6 engine, prior to 1979, with low port heads. 1979 and later engines used the high port head identifiable by a freeze plug in the front of the head. This header designed for high port head.
- 113) Fits fuel injection engines only.
- 114) Will fit aluminum powerglide trans only.
- 115) Requires engine to be moved 1" to right side. Tilton or Hamburger type starter also required.
- 116) This header requires the use of 1969-70 Mustang 302 Boss or 351 Boss frame mount brackets, motor mounts and clutch equalizer shaft for manual transmission applications.
- 117) Reducers available with oxygen sensor on 1980 and later models. See page 61.
- 118) This header requires Hooker frame mount #12651HKR for GM 4 speed.
- 119) This header requires the fabrication of transmission mounts.
- 120) Will fit Corvette D-port aluminum angle plug heads.
- 121) Will not fit with Turbo 400 unless trans crossmember is set back 2" at the mount.
- 122) Three tubes over frame on passenger side and one tube over frame on driver's side.
- 123) Dog Leg Port.
- 124) Dual kit fits only standard 16 gallon gas tank.
- 125) Will not fit 1977 1/2 and later Lo-Boy.
- 126) Some factory heads do not have bolt hole in end. Holes must be drilled and tapped to assure proper seal.
- 127) Will not fit angle plug heads.
- 128) This header requires fabrication of engine/transmission mounts, Muncie 4-speed and Chevette rack and pinion steering.
- 129) Will not fit 1982 Buick Century (front wheel drive).
- 130) Header dual exhaust system fits 1973-87 only.
- 131) Available with fitting to accommodate oxygen sensor. Add an X in front of the part number when ordering.
- 132) This header requires Hooker frame mount #12677HKR. Use factory stock rear transmission mount. Requires use of factory Ford motor mounts from a 1973-79 Ford truck with a 460 Ford engine. This part has been discontinued from Ford. A salvage yard version must be located.
- 133) Header dual exhaust system fits 1963-82 only.
- 134) This swap requires original frame stands and motor mounts from either 2 or 4WD 1983 Fords with a 460.
- 135) This is a Tri-Y header. Primary length 15", secondary length 17".
- 136) Modification of rear crossmember necessary for installation of left-hand collector.
- 137) This header requires use of Advanced Adapter Swap Kit.
- 138) Will not fit with heater.
- 139) Front differential pinion is below centerline of axle.
- 140) Front differential pinion is above centerline of axle.
- 141) See pages 49 & 50 for Specialty Exhaust Product applications.
- 142) Will not fit hydraulic clutch.
- 143) Part number 16862HKR will fit 1979-85 cars if a double hump trans crossmember is used.
- 144) When this header is installed on clutch equipped cars, top racers have found improved performance when 4" Classic #11762HKR or Merged #14762HKR collectors are used. Collectors purchased separately.
- 145) Headers will fit only if stock small block frame stands and motor mounts are used.
- 146) This header requires Hooker front frame mounts #12609 and Hooker transmission mount #12649HKR for Turbo 400. Powerglide and Turbo 350 transmissions may use stock transmission crossmember.
- 147) See page 37-41 for more information on Hooker Super Competition Cat-Back exhaust systems.
- 148) Headers will fit their respective applications only if big block engine frame stands are used from the following applications; Camaro 1970-72, Chevrolet 1968-72, Nova 1968-72.
- 149) Does not fit fuel injection engines.
- 150) Will fit on angle plug heads except 3/4" reach plug applications.
- 151) Header designed to fit Ram Air II/IV, Super Duty, HO and Edelbrock Performer RPM heads only.
- 152) This header is exempted from the prohibitions of Section 27156 of the California Vehicle Code for 1975-82 Chevrolet/GMC trucks and Blazer/Jimmy equipped with an engine of displacement between 305-400 cubic inch engines, excluding those catalytic equipped vehicles using feedback controls (CARB E.O. #D-164.). Dual kit runs outside frame.
- 153) Dual kit exits in front of rear wheels.
- 154) Will not fit manual transmissions during 1971-76.
- 155) Long wheel base only.
- 156) Will not fit stock manifolds that exit straight down.
- 157) Dual kit will not fit vans with dual O.E.M. air conditioning.
- 158) Dual kit will not fit 1968-72 pickups with camper special gas tank.
- 160) Dual kit runs down right hand side between frame and drive shaft.
- 161) Manifold duals will not fit 1965-67.
- 162) Manifold duals fit 1965-76.
- 163) Will only fit 16 bolt F.E. cylinder heads with the top four exhaust bolt holes in line. Will not seal properly on heads with the end upper bolts lower than the center bolts.
- 164) Will only fit F-250 models manufactured before 2/1/77.
- 165) Engine swap mount kit #12678HKR requires the purchase of (2) isolators, seal pump #270-2290 and (2) Ford engine mounts #D3LY-6030A right side and #D3LY-6031A left side.
- 166) Engine swap mount kit #12679HKR requires the purchase of (2) Anchor engine mounts #2329 or equivalent.
- 167) Super Competition exhaust system #16922HKR will not fit with Muncie SM420 cast iron transmission.
- 168) This is a tuned equal length "SHORTY" style header which will bolt directly to the factory exhaust head pipes.
- 169) This is a 50 state legal header C.A.R.B. E.O.#D-164-7.
- 170) This is a replacement "SHORTY" style header that bolts directly to the factory headpipes and accommodates air injection.
- 171) Header includes a high flow Y-pipe and flange to accommodate stock catalytic converter. Will not fit 1995 dual catalytic converter cars. Some cutting and welding required.
- 172) System accommodates oxygen sensors and air injection.
- 173) Fits T.P.I. engines with single 3" inlet catalytic converter only. Includes a high flow Y-Pipe.
- 174) This exhaust system is supplied without mufflers. It is designed to use Hooker Aero Chamber #21502HKR, Maximum Flow #21602HKR or equivalent.
- 175) Requires use of 1966 and later motor mounts and frame mounts Ford P.N. D00Z6038G and because of possible chassis sag the shock towers must measure a minimum of 33 3/4" measured between the top of the shocks. Header will fit with C-6 transmission.
- 176) This system has been designed to accommodate the following Hooker mufflers: Aero Chamber P.N. 21502, Maximum Flow P.N. 21602HKR, Super Competition Turbo P.N. 21106HKR or Competition Turbo P.N. 21006HKR. Chrome or stainless tips are available separately. Tip inlet I.D. required is 2 1/2".
- 177) Engine Code is the eighth digit in the VIN Code.
- 178) Fits 93-94 pickups with stock dual exhaust outlets.
- 179) Includes 2 1/2" high flow Y-Pipe to accommodate stock catalytic converter.
- 181) This is a replacement "Shortie" style header which will bolt directly to the factory exhaust headpipes.
- 182) Installation requires purchase of muffler/tailpipe hanger brackets Ford P/N 4Z2-5A246 and 6Z2-5C236A
- 183) 79-85 models require use of 86 or later double hump crossmember.
- 184) Factory style big block frame stands and motor mounts must be used to ensure proper engine locations and header fit. 67-69 Camaro & 73-75 Nova versions are currently available from "Rick's First Generation Camaro"
- 185) Will not fit with Edelbrock angle plug heads.
- 186) Will not fit 168 tooth flywheel/flexplate applications unless IMI starter part number IMI-102 is used.

THEET F RCE HEADERS
 CAMARO / FERRIBD L31 HEADERS & Y-PIPE
 C MPEITTI N HEADERS
 MUSTANG GT EXHAUST SYSTEM
 SUPER C MPEITTI N HEADERS
 RACE HEADERS
 C MPEITTI N & SUPER C MPEITTI N EXHAUST KITS
 DIESEL EXHAUST SYSTEMS
 CATBACK SYSTEMS
 MUFFLERS
 EXHAUST TIPS
 C MPEITTI N & ACCESS RIES
 HEADER & C LLECT R GASKETS
 F TIN TIES
 PART T GALLERY
 PART # T PAGE INDEX
 WARRANTY

FOOTNOTES & PRODUCT GALLERY

STREET FORCE HEADERS

CAMARO/FIREBIRD LS1 HEADERS & YPIPE

COMPETITION HEADERS

MUSTANG GT EXHAUST SYSTEM

SUPER COMPETITION HEADERS

RACE HEADERS

COMPETITION & SUPER COMP EXHAUST KITS

DIESEL EXHAUST SYSTEMS

CATBACK SYSTEMS

MUFFLERS

EXHAUST TIPS

COMPONENTS & ACCESSORIES

HEADER & COLLECTOR GASKETS

FOOTNOTES

PHOTO GALLERY

PART # TO PAGE INDEX

WARRANTY

- 187) This header will fit the TFS Twisted Wedge race head. The inner flange is not used. Head has been drilled to accept the outer flange and uses the provided $\frac{3}{16}$ " header bolts.
- 188) Will not fit 1963-65 Fairlanes. See part number 6134HKR
- 189) This is a replacement "Shortie" style header which will bolt directly to the factory exhaust headpipes.
- 190) Will not fit Dart 360 aluminum head because of $\frac{1}{4}$ " taller port location.
- 191) Push Bars with a manufactured date code of 1-01-97 or later will fit the 1997 models.
- 192) Installation requires removing or trimming bumper guards and relocation of fog lamps.
- 193) $2\frac{1}{4}$ " O.D. Cross Bars.
- 194) Will not fit vehicles with ground effects kit.
- 195) These exhaust systems require center inlet/offset outlet mufflers. Aero Chamber mufflers are not available in this configuration. We recommend using Maximum Flow #21601HKR, Super Competition Turbo #21105HKR or Competition Turbo #21005HKR mufflers with these kits.
- 196) Will not fit with C-6 transmission.
- 197) Will fit with the 82 and later Lakewood scattershield.
- 198) Fits with a 4 bolt flange catalytic converter.
- 199) Systems available with show quality chrome tailpipes.
- 200) Hooker headers for MOPAR 383-440 engines will bolt on the popular aftermarket B-S heads. However, because the exhaust port centerline on these heads is $\frac{5}{8}$ " higher and $\frac{3}{8}$ " out from the engine centerline compared to stock heads, some header modifications will be required for installation. Custom header applications will be required to fit the B-1 heads because of angled spark plug location.
- 201) Hooker headers for MOPAR 318-360 engines will bolt on the popular aftermarket B-A heads. However, because the exhaust port centerline on these heads is $\frac{5}{8}$ " higher and $\frac{3}{8}$ " out from the engine centerline compared to stock heads, some header modifications will be required for installation. Spark plug locations require cutting header flanges for clearance.
- 202) Header flange uses Reher and Morrison 18° sub-plate bolt pattern
- 203) This is a true dual system utilizing 2 Maximum Flow Mufflers.
- 204) Does not fit 2 speed automatic transmission.
- 205) Dart head applications require using Accel short spark plugs #276-S and 90° Taylor spark plug boots for needed clearance.
- 206) Will fit only with block mount starter.
- 207) Will not fit with Edelbrock aluminum heads.
- 208) GT applications require tips to complete installation. See pages 51 & 52.
- 209) Fits with 168 tooth flywheel.
- 210) Does not fit dual catalytic equipped cars.
- 211) Does not fit with 168 tooth flywheel.
- 212) Does not fit with AFR angle plug heads.
- 213) Fits 62-65 Fairlanes only.
- 214) This header does not fit the Cutlass Supreme Model.
- 215) This is a 50 state legal header C.A.R.B. E.O. # D-164-5.
- 216) Designed for lifted vehicles only. A minimum of $2\frac{1}{2}$ " lift is required.
- 217) This is a 50 state legal header C.A.R.B. E.O. # D-164-6.
- 218) Will not fit dual air pump.
- 219) 86-87 models need to fabricate headpipes.
- 220) 98 models with engine families WCRXAO360H31 and WCRXAO360J31 are not 50 state legal.
- 221) This header will fit with factory air conditioning on 64-67 Chevelle and El Caminos.
- 222) Fits 2WD model only.
- 223) This is a "shortie" style header for maximum ground clearance.
- 224) Will not fit with passenger car heads.
- 225) This systems exits behind the rear wheels.
- 226) Will fit C-6 transmission.
- 228) This is a 50 state legal header C.A.R.B. E.O. #D-164-8.
- 229) This is a 3 step header ($1\frac{1}{8}$ ", 2 ", to $2\frac{1}{8}$ ") that is designed to fit with Danchuk sidemount and transmission crossmember.
- 231) Will not fit VIN "w" if ordered with air tubes.
- 232) Will not accommodate 605 gear box.
- 233) Aluminized "X" pipe that bolts to factory and aftermarket cat-backs is available under P/N 16762HKR
- 234) Aluminized "Y" pipe that bolts to factory and aftermarket cat-backs is available under P/N 16723HKR
- 235) Does not fit 4WD
- 236) Includes oxygen sensor extension harness(s)
- 237) Will fit with 168-tooth flywheel if used with Powermaster mini starter P/N 9500
- 238) Fits both LT-1 engines and standard Chevrolet small-block engines
- 239) Requires use of Anchor mount #2292
- 240) Requires use of Anchor mount #2713
- 241) Modification required to stock exhaust required to retain catalytic convertor
- 242) Will not fit Saginaw close-ratio power steering
- 251) 4WD drive only
- 252) Aluminized "Y" pipe that bolts to factory or aftermarket cat-back is available under 16767HKR
- 253) Aluminized dual exhaust kits that bolts to 2452HKR is available under 16523HKR
- 254) Aluminized "X" pipe that bolts to factory or aftermarket cat-back is available under 16761HKR
- 256) "Y" pipe will fit with 2460HKR only
- 257) Will not fit heavy duty models
- 258) Aluminized "Y" pipe that bolts to factory or aftermarket cat-back is available under 16765HKR.
- 259) Redesigned for better clearance for idler arm. Collector is in original location.
- 260) Will fit 605 gearbox.
- 261) Will not fit knockout style oil pan
- 262) Will not fit with Moroso rear sump pan.
- 263) Requires modifications to the crossmember.
- 264) Comes with show polished stainless tips.
- 265) Redesigned for improved clearances.
- 266) Factory style big block frame stands and motor mounts must be used to ensure proper engine locations and header fit. 64-77 Chevelle versions are currently available from "Original Parts Group"
- 267) Factory style big block frame stands and motor mounts must be used to ensure proper engine locations and header fit.
- 268) Will fit with most aftermarket engine mounts that utilize a base plate that bolts to stock block location combined with an offset upper frame adaptor.
- 269) These headers will not fit any factory application with side engine mounts including 63-82 Corvette.
- 270) Includes extension pipes for use with factory exhaust manifolds or EO headers.
- 271) Includes 2 stainless steel Aero Chamber mufflers with stainless steel tips.
- 272) Includes Y-pipe assembly.
- 273) With EGR, w/o air.
- 274) With EGR.
- 275) Without EGR
- 276) With air.
- 277) Stainless steel "X" pipe that bolts to factory or Aero Chamber™ muffler is part number 16874HKR.
- 278) No EGR fitting for 97-98 model years.
- 279) High performance cross-pipe and muffler sets are available.
- 280) With 3" long transition Power Spear™ collector.
- 281) Not Cobra Jet
- 282) Requires street and performance engine adaptor kit
- 283) Requires Hooker LS1 adaptor plate P/N 12611HKR
- 284) Includes 3" to 2.5" reducers with O₂ fittings
- 285) Use cross-pipe 16784HKR for EO headers without catalytic converters. Use cross-pipe 16684HKR for Full Length headers or EO headers with catalytic converters.
- 286) Will work with Hooker's full line of exhaust tips
- 287) Driver side #3 cylinder primary tube incorporates bap for power steering box clearance
- 288) Headers fit with close-ratio steering box
- 289) Use ARP 12-point head bolts
- 290) Will fit with AOD (not AODE) transmissions using factory iron or aluminum heads or any aftermarket head with stock horizontal bolt, plug location and plug height. Shift lever must be upright, between the 10 to 2 o'clock position.
- 291) Will fit with AOD (not AODE) transmissions with removal of passenger side casting boss located at the 2 o'clock position. Shift lever must be upright, between the 10 to 2 o'clock position.
- 292) Interference on passenger side shock tower will occur when retrofitting 1970 and later 304, 360 & 401s into 1968-69 bodies

* This part number is special order only.
 (*) Not legal for sale or use on vehicles originally equipped with catalytic converters - for racing use only and not intended or applicable for highway use.



TRUCK F RICE HEADERS
 CAMARO / FIREBIRD LS1 HEADERS & Y-PIPE
 C AMPETTI N HEADERS
 MUSTANG GT EXHAUST SYSTEM
 SUPER N HEADERS
 RACE HEADERS
 C AMPETTI N & SUPER C MP EXHAUST KITS
 DIESEL EXHAUST SYSTEMS
 CATBACK SYSTEMS
 MUFFLERS
 EXHAUST TIPS
 C MP NERTS & ACCESSORIES
 HEADER & C LLECT R GASKETS
 F TM TES
 PART # T PAGE INDEX
 WARRANTY

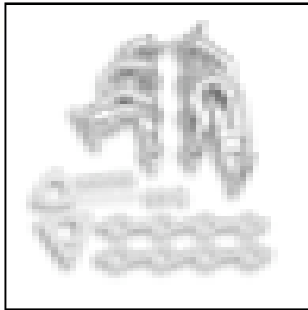

1998 350 LS1
CAMARO/FIREBIRD
2077-1HKR

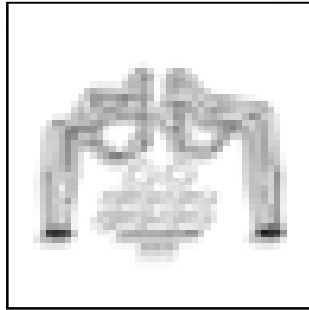

1955-57 396-502 CHEVY
PASSENGER/WAGON
2244-1HKR

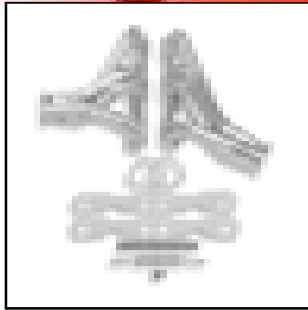

1982-92 265-400
CHEVY CAMARO
2460-1HKR

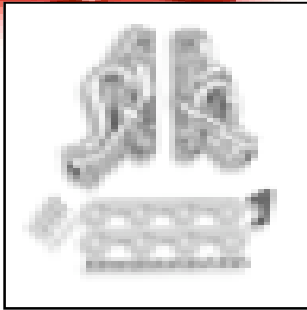

1986-93 255-302
MUSTANG
6128-1HKR

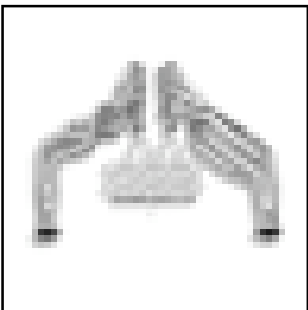

1979-93 255-302
MUSTANG (FULL LENGTH)
6227-1HKR

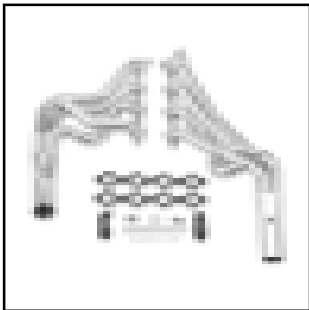

1998-99 350 LS1
CAMARO (FULL LENGTH)
2253-1HKR

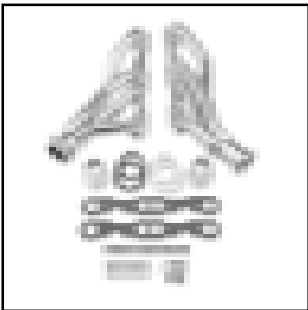

1970-87 283-400 MONTE CARLO,
1967-81 283-400 CAMARO,
1968-79 283-400 CHEVY II/NOVA
2466-1HKR

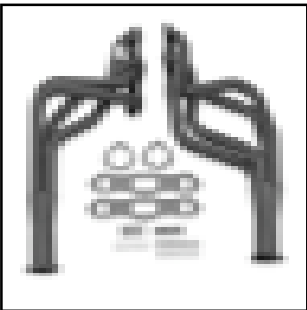

1977 350-403
BUICK REGAL, CENTURY & WAGON
3107HKR

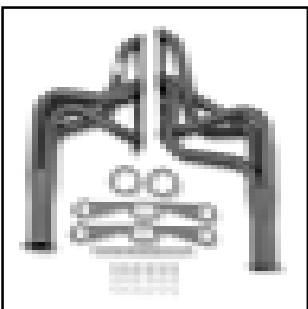

1970-81 326-455
FIREBIRD/TRANS-AM
4109HKR

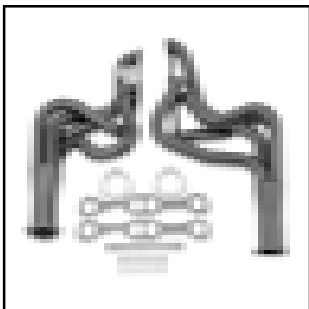

1968-72 400-455 HO/SD
PONTIAC GTO/LE MANS
4201HKR

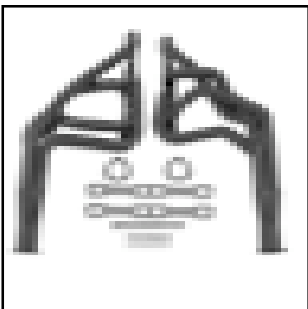

1967-74 383-440
DODGE CHALLENGER, CHARGER,
CORONET, WAGONS (B&E BODIES)
5101HKR

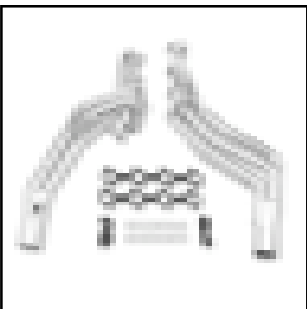

1996-03 4.6L (2 VALVE)
MUSTANG (FULL LENGTH)
6230-1HKR

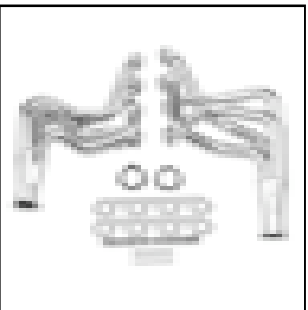

1988-95 460
FORD F-250, F-350
6842-1HKR



1994-96 350 LT1
IMPALA SS
2063-1HKR

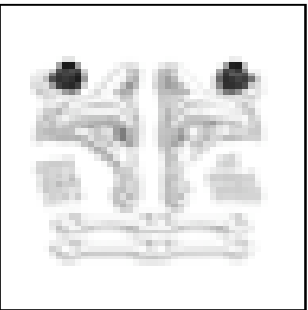

CHEVY 262-400
BLOCK HUGGER
2001HKR



1992-95 305-350
CHEVY 1500, 2500, 3500, BLAZER,
JIMMY, YUKON, SUBURBAN, TAHOE
2065HKR

Tech Line: 270-781-9741

PRODUCT GALLERY

STREET FORCE HEADERS

CAMARO/FIREBIRD LS1 HEADERS & YPIPE

COMPETITION HEADERS

MUSTANG GT EXHAUST SYSTEM

SUPER COMPETITION HEADERS

RACE HEADERS

COMPETITION & SUPER COMP EXHAUST KITS

DIESEL EXHAUST SYSTEMS

CATBACK SYSTEMS

MUFFLERS

EXHAUST TIPS

COMPONENTS & ACCESSORIES

HEADER & COLLECTOR GASKETS

FOOTNOTES

PHOTO GALLERY

PART # TO PAGE INDEX

WARRANTY

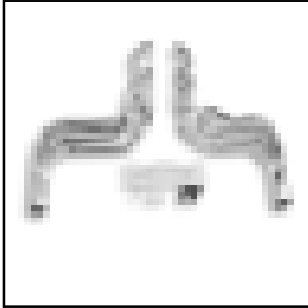

1963-82 265-400
CORVETTE
2234HKR



262-400 CHEVY
(CLASSIC 23T BUCKET) ROADSTER
2326HKR



396-502
TRACTOR/PULLER
2542HKR

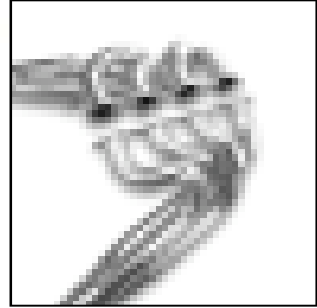

396-502 DOWN SWEPT
DRAGSTER, SUPER COMP,
COMP ELIMINATOR
2404-1HKR

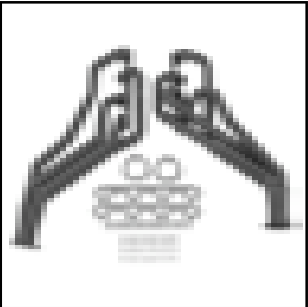

1962-65 260-289W
FORD FAIRLANE/METEOR
6134HKR

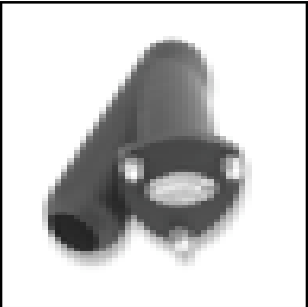

RACING CUT-A-WAY
11190HKR

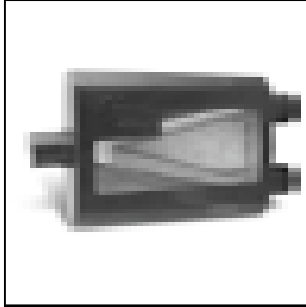

MAXIMUM FLOW™
CUT-A-WAY MUFFLER
21699HKR

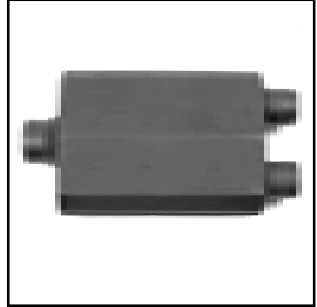

3" SINGLE - 2.5" DUAL OUT
AERO CHAMBER™ MUFFLER
21518HKR

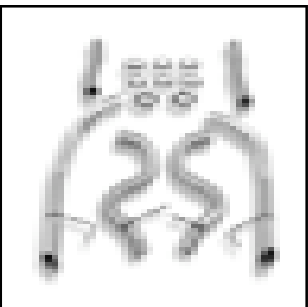

1996-02 4.6L
MUSTANG GT CATBACK SYSTEM
16870HKR

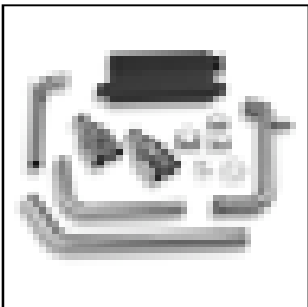

1998-02 350 LS1
CAMARO/FIREBIRD CATBACK
16811HKR

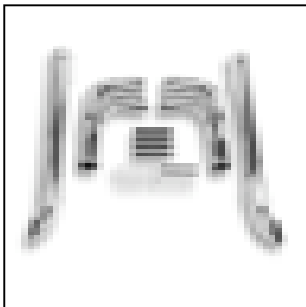

UNIVERSAL CHROME
SIDEMOUNTS
21063HKR



TUNED FLOW™
STRAIGHT CUT SLIP-ON MUFFLER
21902HKR

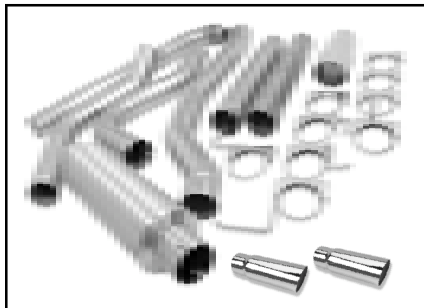

Dodge 94-02 Dual Outlet
16945-2HKR

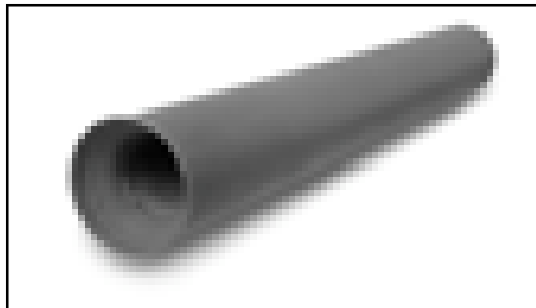

MAXIMUM FLOW™
SIDESPIPE MUFFLER
21046HKR

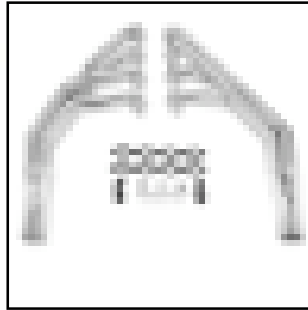

1967-69 350 LS1
CAMARO/FIREBIRD
2288-1HKR

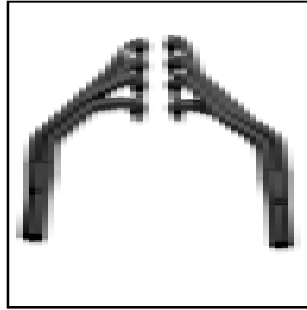

1964-72 350 LS1
CHEVELLE, MALIBU, EL CAMINO,
GRAN SPORT/SKYLARK, CUTLASS 442,
GTO, LE MANS
2289HKR

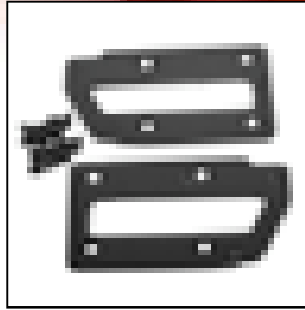

1967-69 CHEVROLET/PONTIAC F-BODY,
64-72 CHEVY/PONTIAC/
OLDSMOBILE/BUICK
A-BODY LS1 ENGINE SWAP MOUNT
12611HKR

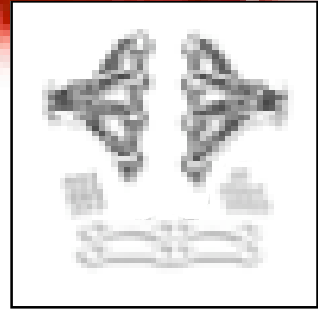

350 LS1 SUPER COMPETITION
BLOCK HUGGER,
CHROME
2315HKR

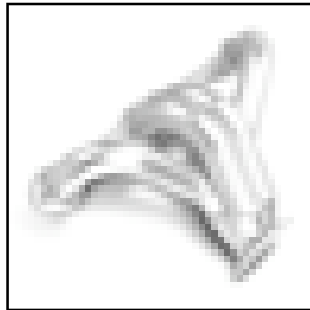

POLISHED CERAMIC COATED
BLOCK HUGGER FOR
CHEVY FAST BURN D-PORT HEADS
2301HKR

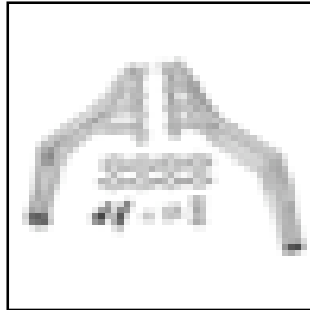

98-99 350 LS1 CAMARO/FIREBIRD
COMPETITION HEADER
2468-1HKR

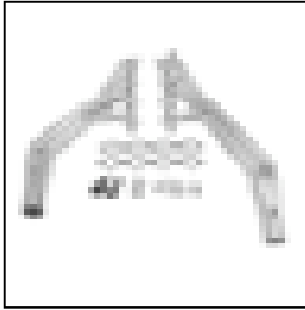

98-99 350 LS1 CAMARO/FIREBIRD
SUPER COMPETITION HEADER
2290-1HKR

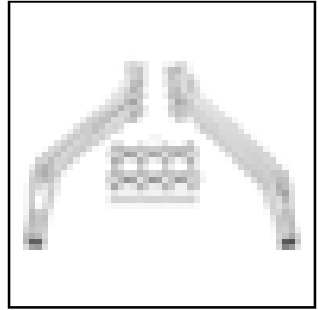

05-PRESENT MUSTANG GT4.6L V8
(3 VALVE) SUPER COMPETITION
FULL LENGTH HEADER
6233-1HKR

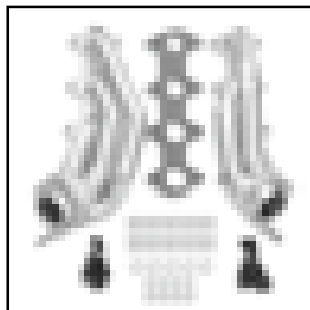

05-06 MUSTANG GT 4.6L V8
STREET FORCE®
EMISSION COMPATIBLE
6138-1HKR

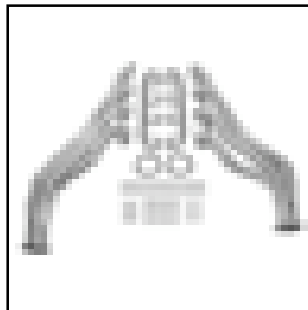

68-74 5.7L HEMI DODGE CHALLENGER,
CHARGER, CORONET,
WAGONS (B&E BODIES), R/T SUPER BEE,
PLYMOUTH, BELVEDERE, GTX,
ROAD RUNNER, SATELLITE, SEBRING,
BARRACUDA (70-74),
SPORT FURY (75-77),
WAGONS (B&E BODIES)
5020-1HKR

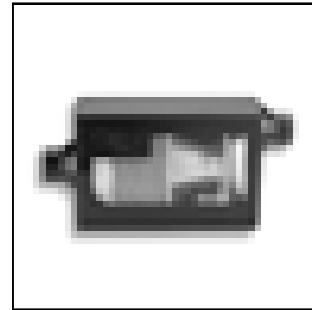

AERO CHAMBER™
MUFFLER CUTAWAY
21599HKR

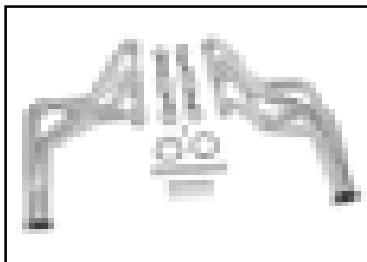

'78-87 265-400CH BUICK REGAL, CUTLASS 442,
'65-89 265-400 CHEVY/GMC PASSENGER, WAGON,
'64-87 265-400 CHEVY CHEVELLE, EL CAMINO/ CALLABERO, SPRINT,
'70-87 265-400 CHEVY MONTE CARLO,
'68-79 265-400 CHEVY II, NOVA,
'67-81 265-400 CHEVY CAMARO,
'78-81 265-400CH PONTIAC FIREBIRD,
'77-87 265-400CH PONTIAC PHOENIX, VENTURA, GRAND PRIX
2451-1HKR

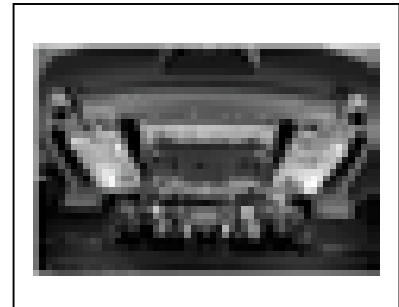

05-PRESENT MUSTANG GT
AERO CHAMBER™
STAINLESS STEEL MUFFLER SET
21521HKR

Tech Line: 270-781-9741

TRUCK & SUV
CAMARO / FIREBIRD LS1 HEADERS & Y-PIPE
MUFFLER
EXHAUST SYSTEM
UPPER MUFFLER
R E
MUFFLER & UPPER MUFFLER KIT
DUAL EXHAUST
Y-PIPE
MUFFLER
EXHAUST TIP
& MUFFLER
HEATER & EMISSION
HEATER & EMISSION KIT
FUEL INJECTION
PARTS INDEX
WARRANTY

PRODUCT GALLERY

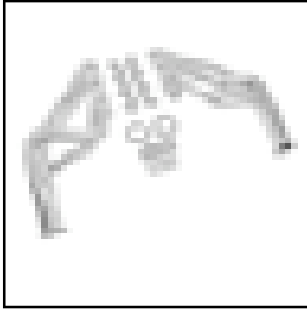

SB FORD, MUSTANG, COUGAR,
TORINO, CYCLONE ETC.
6901-1HKR

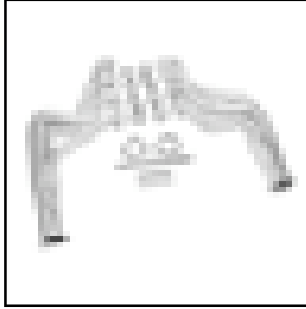

BB CHEVY 70-72 CAMARO
2455-1HKR

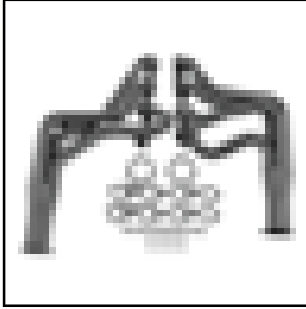

BB CHEVY SWAP 78-87 G BODY
2241HKR

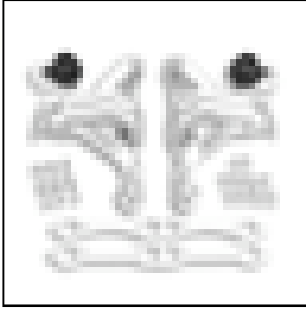

SB CHEVY BLOCK HUGGER, COATED
2001HKR



SB CHEVY BLOCK HUGGER, PAINTED
2100HKR

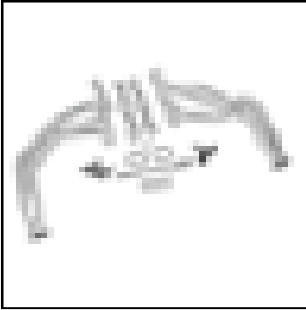

SB CHEVY PICK-UP, SUV
2452-1HKR



1994-96 350 LT1
IMPALA SS
2063HKR

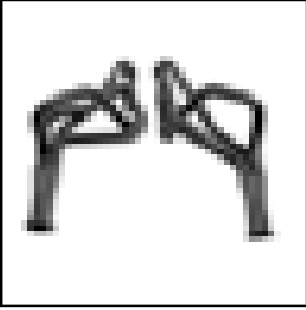

SB CHEVY, 78-87 G BODY
2242HKR

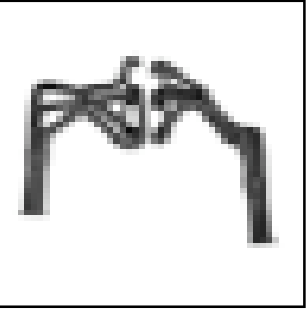

67-70 SB MOPAR A & F BODY
5116HKR

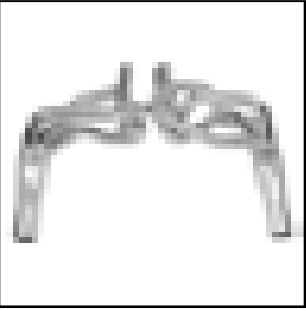

62-74 BB WEDGE MOPAR B & E BODY
5320-1HKR

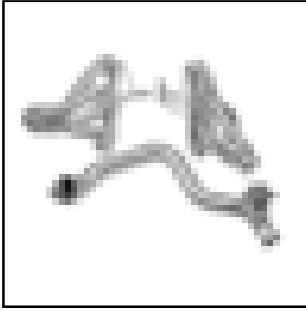

SB CHEVY 83-88 G BODY
2049-1HKR

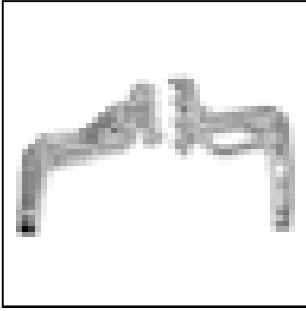

352-400M FORD PICK-UP
6832-1HKR

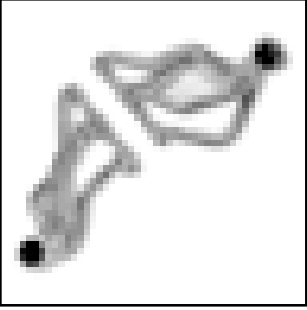

SB CHEVY 58-64 PASSENGER CAR
2103-1HKR

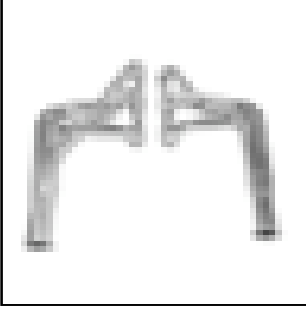

SB CHEVY CAMARO, NOVA
2117-1HKR

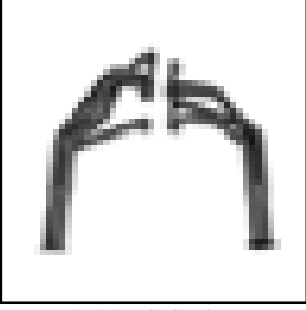

SB CHEVY 62-67 NOVA
2122HKR

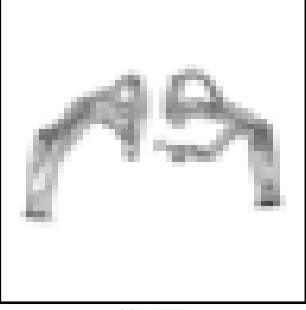

CORVETTE
2149-1HKR

STREET R & HE DERS

CAMARO/FIREBIRD LSI HEADERS & YPIPE

M ETITI N HE DERS

MUSTANG GT EXHAUST SYSTEM

SU ER M ETITI N HE DERS

R & HE DERS

M ETITI N & SU ER M HE LIST KITS

DIESEL E H LIST S STEMS

TB K S STEMS

MUFFLERS

E H LIST TIS

M ENITS & ESS RIES

HE DER & ULE T R G SKETS

F TN TES

PHOTO GALLERY

RT GE INDE

WR RR NT

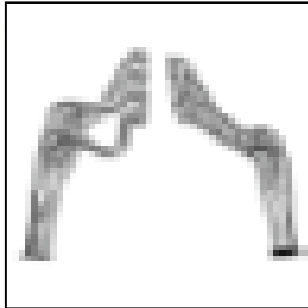

BB CHEVY 64-67 CHEVELLE
2213-1HKR

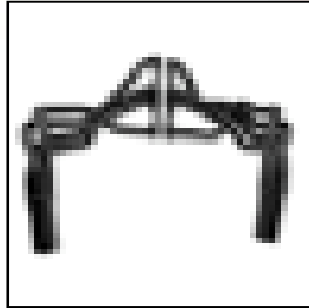

SB CHEVY CORVETTE SIDEMOUNT
2224HKR

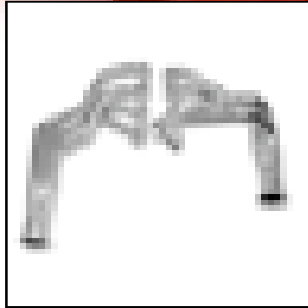

BB CHEVY VEGA, MONZA, ETC.
SWAP HEADER
2240-1HKR

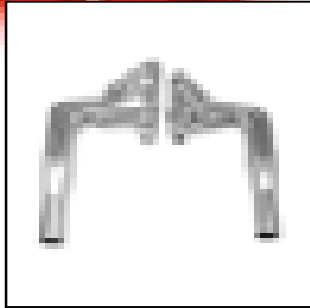

SB CHEVY NOVA
ADJUSTABLE RACE
2308-1HKR

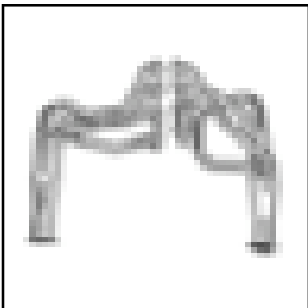

BB CHEVY PICK-UP, SUV
2817-1HKR

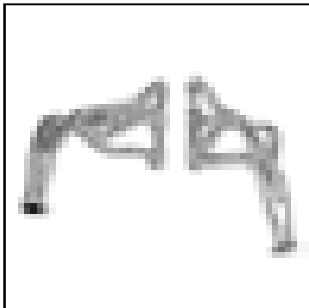

SB CHEVY PICK-UP, SUV
2827-1HKR

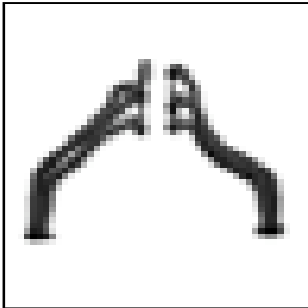

V6 S10, BLAZER
2842HKR

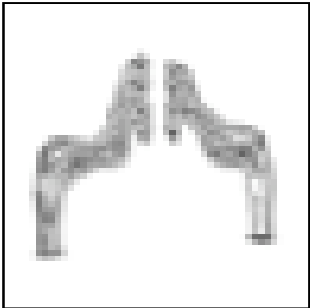

BB CHEVY PICK-UP
2849-1HKR

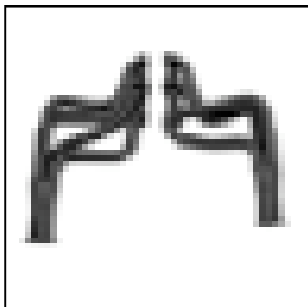

BB OLDSMOBILE DELTA 88,
VISTA CRUISER
3902HKR

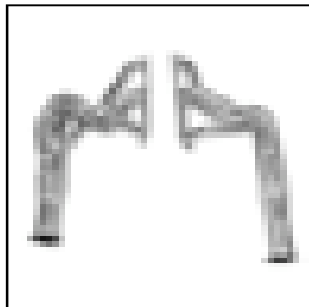

67-69 FIREBIRD/TRANS AM,
72-74 VENTURA
4107-1HKR

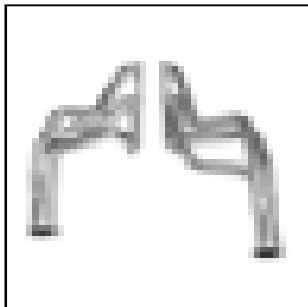

67-69 FIREBIRD/TRANS-AM
4902-1HKR

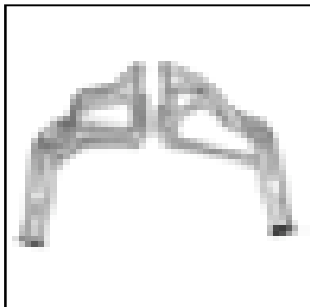

BB MOPAR 68-77 C BODY
5113-1HKR

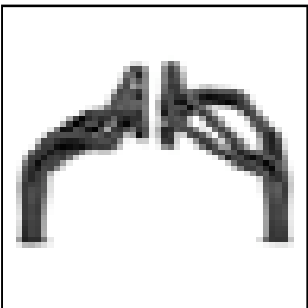

SB FORD 79-93 MUSTANG
6225HKR

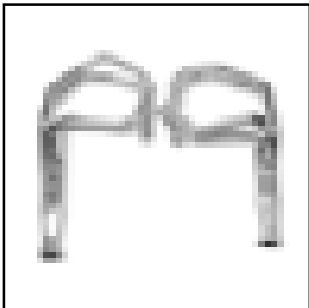

SB FORD PINTO SWAP HEADER
6160-1HKR

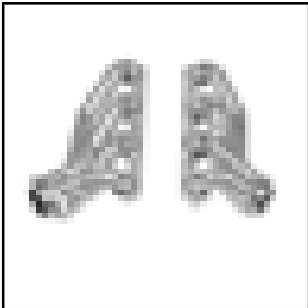

351W 94-95 MUSTANG
SWAP HEADER
6133-1HKR

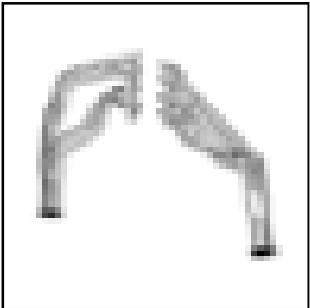

390-428 TORINO,
CYCLONE FAIRLANE, ETC.
6113-1HKR

INTER
HE DER

CAMAR /
FIREBIRD LSI
HEADERS &
Y-PIPE

MERITTI N
HE DER

MUSTANG GT
EXHAUST
SYSTEM

UPER
MERTTI N
HE DER

R E
HE DER

MERTTI N
& UPER
E H U T KIT

DELE E H U T
Y TEM

TS K
Y TEM

MUFFLER

E H U T
TIP

MP NENT
& E RE

HE DER &
LLET R
KET

F T N TE

PH T
GALLERY

P RT#
T P E
INDE

WR RR NTY

Tech Line: **270-781-9741**

PRODUCT GALLERY

STREET R E
HE DERS

CAMARO/
FIREBIRD LSI
HEADERS &
YPIPE

M ETIT N
HE DERS

MUSTANG GT
EXHAUST
SYSTEM

SJ ER
M ETIT N
HE DERS

R E
HE DERS

M ETIT N
& SJ ER M
E H LST KITS

DISEL E H LST
S STEMS

TB K
S STEMS

MUFFLERS

E H LST
TIS

M NENTS
& ESS RIES

HE DER &
LLE T R
G SKETS

F TN TES

PHOTO
GALLERY

RT
T GE
INDE

W RR NT

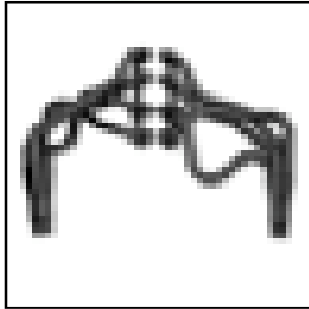

352-390 FORD PICK-UP
6808HKR

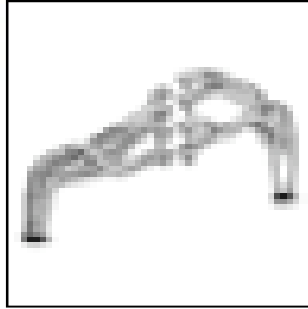

429-460 FORD PICK-UP, BRONCO
SWAP HEADER
6841-1HKR

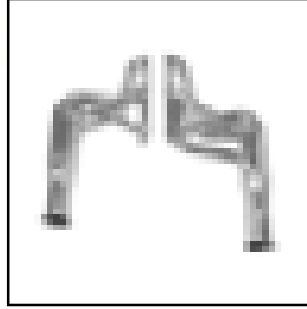

70-79 FIREBIRD/TRANS-AM W
PONTIAC V8
4901-1HKR

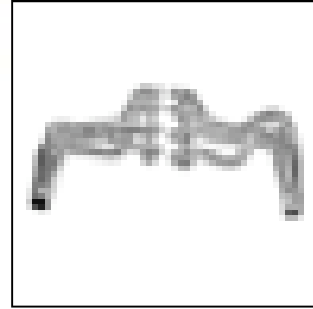

352-390 FORD PICK-UP
6905-1HKR

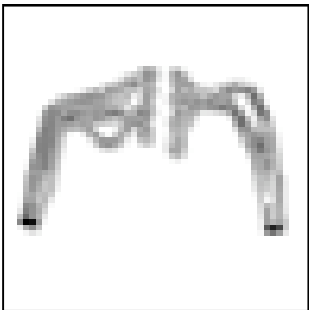

72-80 SCOUT II
9826-1HKR

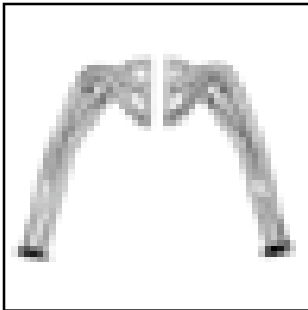

SB CHEVY JEEP SWAP HEADER
9810-1HKR

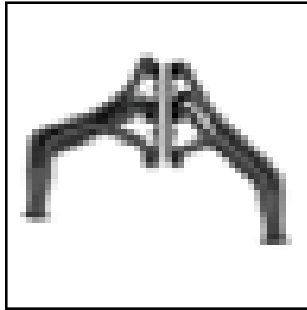

304-401 JEEP CHEROKEE,
WAGONEER, PICK-UP
9402HKR

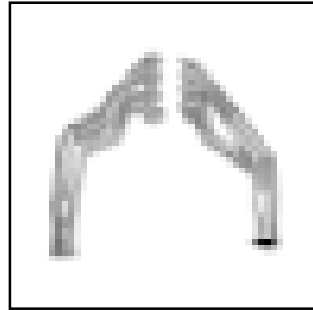

67-70 MUSTANG, TORINO ETC. 351C 4V
6920-1HKR

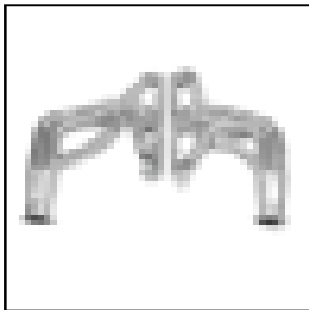

304-401 JEEP CJ5/6/7
9829-1HKR

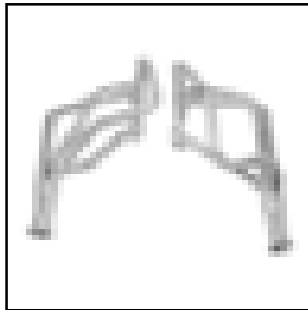

SB CHEVY 75-79 MONZA
2135-1HKR

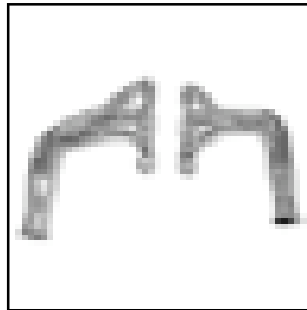

SB CHEVY 55-62 CORVETTE
2108-1HKR

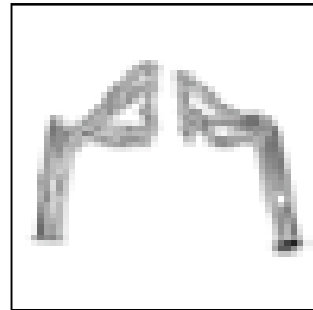

BB CHEVY CAMARO, NOVA
2111-1HKR

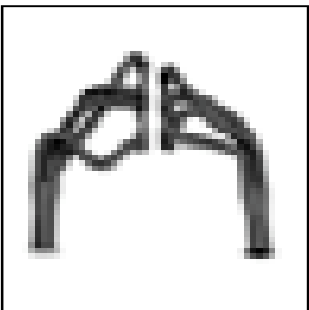

SB CHEVY 55-57 W/605 BOX
2112HKR

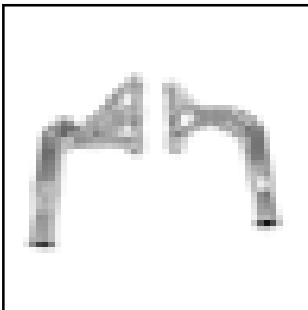

SB CHEVY CAMARO, NOVA
2131-1HKR

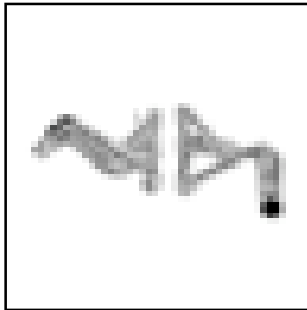

SB CHEVY
2138-1HKR

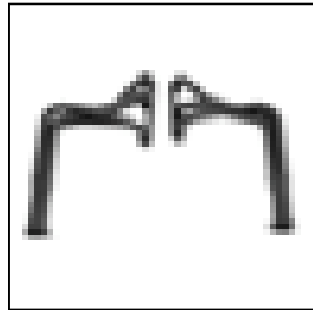

V6 CHEVY G BODY
2143HKR



H E T R E E
 H E D E R
 C A M A R O /
 F I R E B I R D L S 1
 H E A D E R S &
 Y - P I P E
 M I P E T T I N
 H E D E R
 M U S T A N G G T
 E X H A U S T
 S Y S T E M
 U P P E R
 M I P E T T I N
 H E D E R
 R E
 H E D E R
 M I P E T T I N
 & U P P E R
 M I P E
 E H U T K I T
 D R E E L E H U T
 Y T E M
 J B
 K
 Y T E M
 M U L T I P L E R
 E H U T
 T I P
 &
 E
 M P N E U T
 R I E
 H E D E R &
 L E T T E R
 K E T
 F
 T I N T E
 P H I T
 G A L L E R Y
 P R T #
 T P E
 I N D E
 W R R N I Y

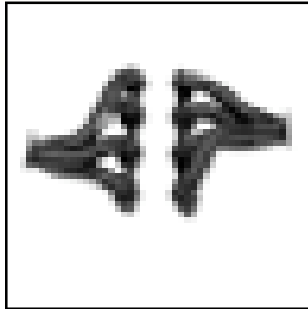

BB CHEV BLOCK HUGGER
2183HKR

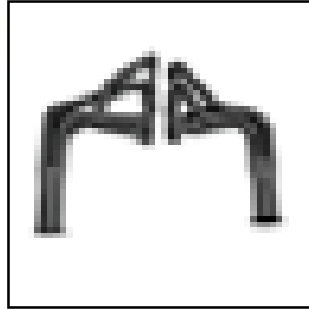

SB CHEV CAMARO, NOVA
2207HKR

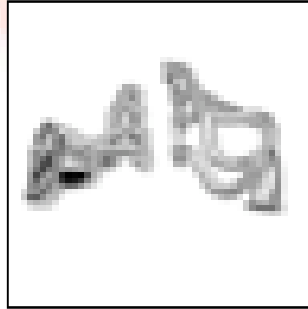

BB CHEVY 82-92 CAMARO
SWAP HEADER
2226-1HKR

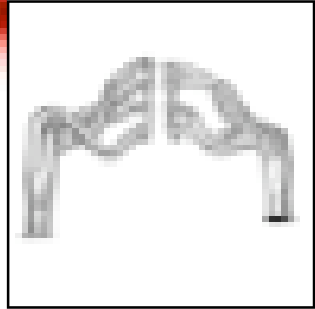

BB CHEVY 55-57
SWAP HEADER
2227-1HKR

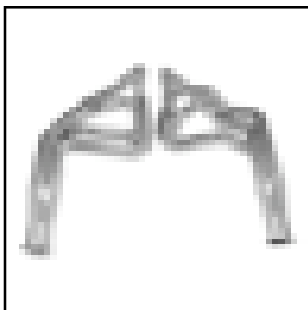

67-75 BB MOPAR B & E BODY
5101-1HKR

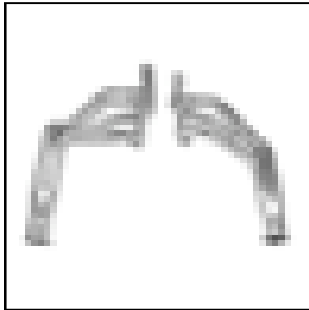

SB CHEVY 62-67 NOVA
2243-1HKR

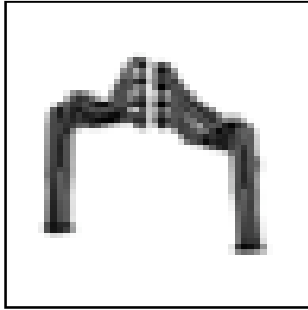

BB CHEVY CAMARO, CHEVELLE
2250HKR

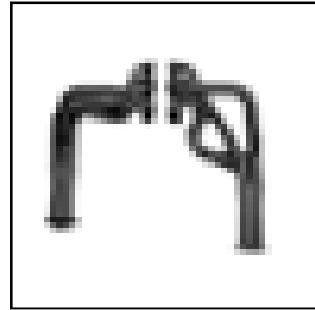

BB OLDSMOBILE 78-87 CUTLASS
SWAP HEADER
3203HKR

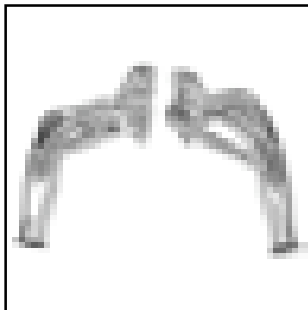

BB CHEVY, 68-72 CHEVELLE
2265-1HKR

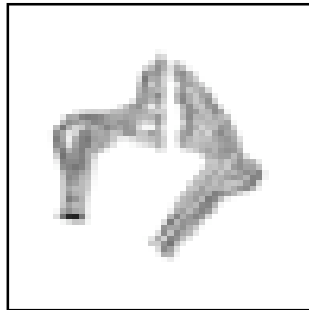

BB CHEVY 62-67 NOVA
SWAP HEADER
2280-1HKR

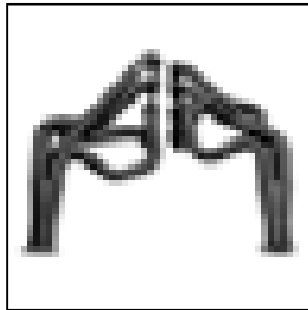

BB CHEVY 73-75 NOVA
SWAP HEADER
2285HKR

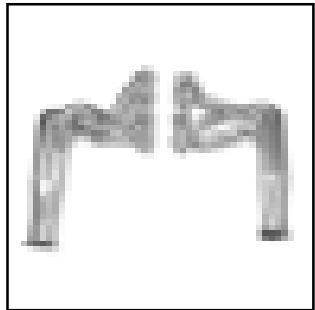

BB CHEVY 70-72 CAMARO
2287-1HKR

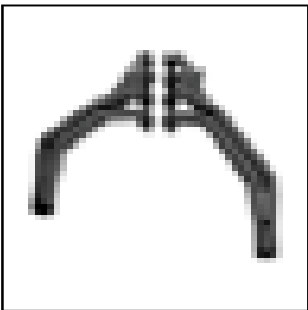

00-02 CAMARO/FIREBIRD LS-1
2291HKR

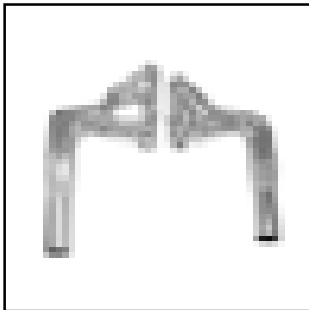

SB CHEVY 67-69 CAMARO ADJUSTABLE
RACE HEADER
2304-1HKR

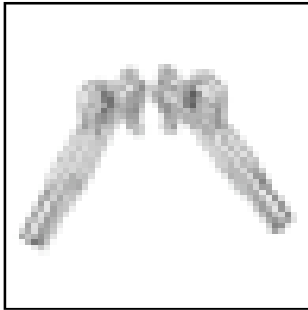

BB CHEVY UPSWEPT DRAGSTER
2310-1HKR

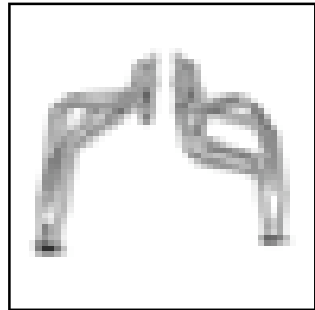

77-78 FIREBIRD TRANS-AM
W/ OLDS V8
3901-1HKR

Tech Line: 270-781-9741

75

PRODUCT GALLERY & PART NUMBER INDEX

STREET R E
HE DERS

CAMARO/
FIREBIRD LSI
HEADERS &
YPIPE

M ETIT N
HE DERS

MUSTANG GT
EXHAUST
SYSTEM

SJ ER
M ETIT N
HE DERS

R E
HE DERS

M ETIT N
& SJ ER M
E H LST KITS

DIESEL E H LST
S STEMS

TR K
S STEMS

MUFFLERS

E H LST
TIS

M ENITS
& ESS RIES

HE DER &
LLET R
G SKETS

F TN TES

PHOTO
GALLERY

RT
T
INDE

W RR NT

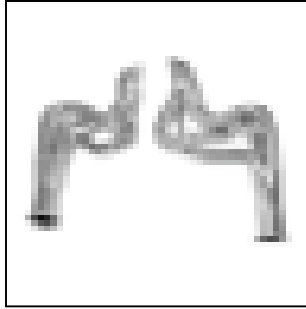

68-72 GTO/LEMANS 400-455 HO/SD
24201-1HKR

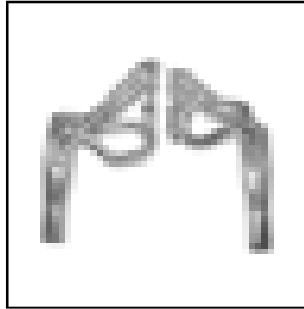

BB CHEVY 68-74 NOVA ADJ. RACE 2-1/8
2386-1HKR

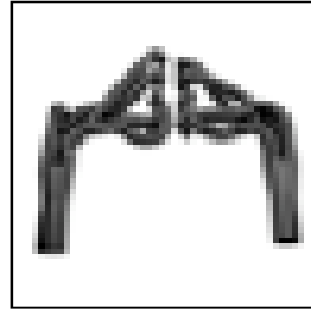

BB CHEVY 68-74 NOVA ADJ. RACE 2-1/4
2401HKR

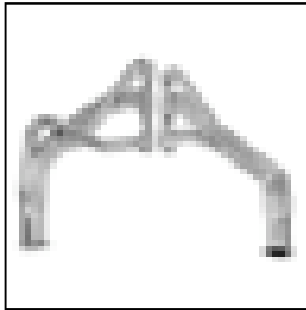

SB CHEVY 55-57
2458-1HKR

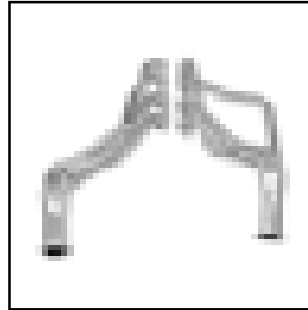

BB CHEVY PICK-UP, SUV
2461-1HKR

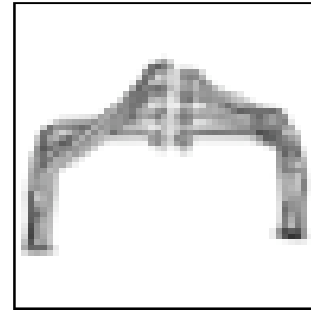

BB CHEVY 68-95 VANS/MOTORHOMES
2454-2HKR

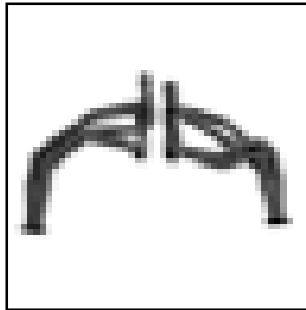

SB CHEVY 63-67 PICK UP
2801HKR

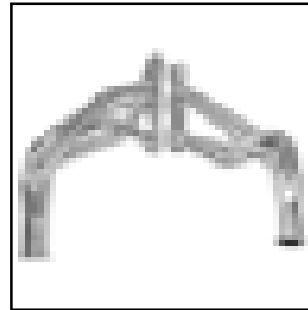

SB CHEVY PICK UP, SUV
2840-1HKR

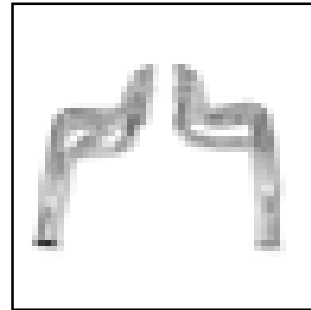

BB OLDSMOBILE CUTLASS, DELTA 88 ETC.
3101-1HKR



THEFT R E
HE DER
CAMAR /
FRIBIRD LSI
HEADERS &
Y-PIPE
MPEITTI N
HE DER
MPEITTI N
HE DER
EXHAUST GT
SYSTEM
MPEITTI N
HE DER
R E
HE DER
& U P I T KIT
MPEITTI N
MPEITTI N
Y TEM
Y TEM
Y TEM
MPEITTI N
E H U T
MPEITTI N
E H U T
& E RE
HE DER &
LET R
F IN IE
PH T
GALLERY
P RT #
T P E
INDE
WR RR NTY

Part #	Pg.	Part #	Pg.	Part #	Pg.	Part #	Pg.
1103HKR	13,17,18	2149HKR	14	2287HKR	14,23,26	2468-1HKR	5,7,10
1103-1HKR	13,17,18	2150HKR	13	2287-1HKR	14,23,26	2468-2HKR	5,7,10
1115HKR	13	2150-1HKR	13,14,15,17,18,20	2288HKR	14,23,26	2469HKR	5,7,10
1203HKR	13	2150HKR	13,14,15,17,18,20	2288-1HKR	14,23,26	2469-1HKR	5,7,10
1203-1HKR	13	2151HKR	14	2289HKR	14,23,24,26	2469-2HKR	5,7,10
2001HKR	29	2151-1HKR	14	2289-1HKR	14,23,24,26	2542HKR	36
2049HKR	4	2171HKR	15	2290HKR	5,14	2602HKR	13,14,17,18
2049-1HKR	4	2171-1HKR	15	2290-1HKR	5,14	2602-1HKR	13,14,17,18
2050HKR	4	2180HKR	29	2290-2HKR	5,14	2801HKR	20
2050-1HKR	4	2180-2HKR	29	2291HKR	5,14	2801-1HKR	20
2055HKR	4	2181HKR	29	2291-1HKR	5,14	2806HKR	20,21,22
2055-1HKR	4	2183HKR	29	2291-2HKR	5,14	2806-1HKR	20,21,22
2060HKR	4	2200HKR	29	2300HKR	29	2808HKR	20
2060-1HKR	4	2201HKR	24	2301HKR	29	2808-1HKR	20
2061HKR	4	2201-1HKR	24	2302HKR	29	2817HKR	21,22,23
2061-1HKR	4	2202HKR	15	2303HKR	29	2817-1HKR	21,22,23
2062HKR	4	2202-1HKR	15	2304HKR	33	2819HKR	20
2062-1HKR	4	2205HKR	14,24	2304-1HKR	33	2819-1HKR	20
2063HKR	4	2205-1HKR	14,24	2308HKR	33	2826HKR	20
2063-1HKR	4	2207HKR	14	2308-1HKR	33	2826-1HKR	20
2064HKR	4	2207-1HKR	14	2310HKR	34	2827HKR	21,22
2064-1HKR	4	2210HKR	14	2310-1HKR	34	2827-1HKR	21,22
2065HKR	20	2210-1HKR	14	2312HKR	29	2837HKR	23
2065-1HKR	20	2210HKR	18	2313HKR	29	2837-1HKR	23
2076HKR	4	2210-1HKR	18	2314HKR	29	2839HKR	23
2076-1HKR	4	2213HKR	14,20	2315HKR	29	2839-1HKR	23
2077HKR	4	2213-1HKR	14,20	2326HKR	31	2840HKR	20
2077-1HKR	4	2214HKR	14	2327HKR	31	2840-1HKR	20
2100HKR	29	2214-1HKR	14	2348HKR	36	2841HKR	20
2100-2HKR	29	2217HKR	14,20,23,24,26	2386HKR	33	2841-1HKR	20
2101HKR	29	2217-1HKR	14,20,23,24,26	2386-1HKR	33	2842HKR	20
2102HKR	15	2220HKR	14	2401HKR	33	2842-1HKR	20
2102-1HKR	15	2220-1HKR	14	2401-1HKR	33	2847HKR	20
2103HKR	15	2222HKR	30	2404HKR	34	2847-1HKR	20
2103-1HKR	15	2222-1HKR	30	2404-1HKR	34	2849HKR	21,22
2108HKR	14	2224HKR	30	2405HKR	34	2849-1HKR	21,22
2108-1HKR	14	2224-1HKR	30	2405-1HKR	34	2850HKR	20
2110HKR	15	2224-3HKR	30	2410HKR	34	2850-1HKR	20
2110-1HKR	15	2225HKR	14,24	2451HKR	7,10	2851HKR	20
2111HKR	14,24	2225-1HKR	14,24	2451-1HKR	7,10	2851-1HKR	20
2111-1HKR	14,24	2226HKR	23,26	2451-2HKR	7,10	2953HKR	35
2112HKR	15	2226-1HKR	23,26	2452HKR	8	2954HKR	35
2112-1HKR	15	2227HKR	24	2452-1HKR	8	2956HKR	35
2113-1HKR	20	2227-1HKR	24	2452-2HKR	8	2957HKR	35
2116HKR	14,15,20	2231HKR	14,18	2453HKR	8	2959HKR	35
2116-1HKR	14,15,20	2231-1HKR	14,18	2453-1HKR	8	3101HKR	17
2117HKR	14,18	2233HKR	30	2454HKR	8	3101-1HKR	17
2117-1HKR	14,18	2233HKR	30	2454-1HKR	8	3104HKR	17
2118HKR	14,15,20,23,24,26	2234HKR	30	2454-2HKR	8	3104-1HKR	17
2118-1HKR	14,15,20,23,24,26	2238HKR	30	2455HKR	7	3107HKR	13,17,18
2122HKR	14	2239HKR	14,18	2455-1HKR	7	3107-1HKR	13,17,18
2122-1HKR	14	2239-1HKR	14,18	2455-2HKR	7	3108HKR	17
2123HKR	14,24	2240HKR	23,24,26	2456HKR	7	3108-1HKR	17
2123-1HKR	14,24	2240-1HKR	23,24,26	2456-1HKR	7	3201HKR	17
2124HKR	14,15,20	2241HKR	23,24,26	2457HKR	7	3201-1HKR	17
2124-1HKR	14,15,20	2241-1HKR	23,24,26	2457-1HKR	7	3202HKR	17
2129HKR	23,24,26	2242HKR	13,14,15,17,18,20	2458HKR	7	3202-1HKR	17
2129-1HKR	23,24,26	2242-1HKR	13,14,15,17,18,20	2458-1HKR	7	3203HKR	26
2130HKR	14,15	2243HKR	14	2459HKR	8	3203-1HKR	26
2130-1HKR	14,15	2243-1HKR	14	2459-1HKR	8	3901HKR	10
2131HKR	14	2244HKR	24	2460HKR	7,10	3901-1HKR	10
2131-1HKR	14	2244-1HKR	24	2460-1HKR	7,10	3902HKR	10
2134HKR	14	2250HKR	14,20,23,24,26	2460-2HKR	7,10	3902-1HKR	10
2134-1HKR	14	2250-1HKR	14,20,23,24,26	2461-1HKR	8	4106HKR	18
2135HKR	15	2253HKR	18	2462HKR	8	4106-1HKR	18
2135-1HKR	15	2253-1HKR	18	2462-1HKR	8	4107HKR	18
2136HKR	14,18	2253-2HKR	18	2462-2HKR	8	4107-1HKR	18
2136-1HKR	14,18	2254HKR	18	2463HKR	8	4108HKR	18
2138HKR	18	2254-1HKR	18	2463-1HKR	8	4108-1HKR	18
2138-1HKR	18	2254-2HKR	18	2464HKR	8	4109HKR	18
2140HKR	24	2265HKR	14	2464-1HKR	8	4109-1HKR	18
2140-1HKR	24	2265-1HKR	14	2465HKR	8	4111HKR	18
2143HKR	14,15	2280HKR	24	2465-1HKR	8	4111-1HKR	18
2143-1HKR	14,15	2280-1HKR	24	2466HKR	7,10	4201HKR	18
2147HKR	24	2285HKR	14,24	2466-1HKR	7,10	4201-1HKR	18
2147-1HKR	24	2285-1HKR	14,24	2468HKR	5,7,10	4202HKR	18

Tech Line: 270-781-9741



PART NUMBER INDEX

Part #	Pg.	Part #	Pg.	Part #	Pg.	Part #	Pg.	Part #	Pg.
4202-1HKR	18	6124-1HKR	16	6827HKR	21,22	9829-1HKR	21	11336HKR	60
4901HKR	10	6125HKR	16	6827-1HKR	22	10801HKR	62	11338HKR	60
4901-1HKR	10	6125-1HKR	16	6829HKR	21,22	10802HKR	62	11340HKR	60
4902HKR	10	6126HKR	16	6829-1HKR	21,22	10803HKR	62	11425HKR	57,61
4902-1HKR	10	6126-1HKR	16	6837HKR	21	10804HKR	62	11430HKR	57,61
5020HKR	15,17,24,26	6128HKR	4	6837HKR	22	10807HKR	62	11435HKR	57,61
5020-1HKR	15,17,24,26	6128-1HKR	4	6838HKR	21,22	10808HKR	62	11510HKR	59
5101HKR	15,17	6129HKR	4	6838-1HKR	21,22	10809HKR	62	11511HKR	59
5101-1HKR	15,17	6129-1HKR	4	6839HKR	25	10810HKR	62	11515HKR	59
5111HKR	15,17	6130HKR	17	6839-1HKR	25	10812HKR	62	11522HKR	59
5111-1HKR	15,17	6130-1HKR	17	6841HKR	24,25	10819HKR	62	11530HKR	59
5113HKR	15,18	6131HKR	4	6841-1HKR	24,25	10820HKR	62	11540HKR	59
5113-1HKR	15,18	6131-1HKR	4	6842HKR	21,22	10822HKR	62	11542HKR	59
5115HKR	15,17	6132HKR	4	6842-1HKR	21,22	10823HKR	62	11552HKR	59
5115-1HKR	15,17	6132-1HKR	4	6843HKR	22	10825HKR	62	11560HKR	59
5116HKR	15,18	6133HKR	4,25	6843-1HKR	22	10827HKR	62	11562HKR	59
5116-1HKR	15,18	6133-1HKR	4,25	6901HKR	9	10828HKR	62	11570HKR	59
5204HKR	15,18	6134HKR	16,17	6901-1HKR	9	10829HKR	62	11621HKR	53
5204-1HKR	15,18	6134-1HKR	16,17	6902HKR	9	10836HKR	62	11622HKR	53
5205HKR	15,18,24,26	6138HKR	4	6902-1HKR	9	10838HKR	62	11626HKR	53
5205-1HKR	15,18,24,26	6138-1HKR	4	6903HKR	9	10845HKR	62	11629HKR	53
5208HKR	15,18	6160HKR	25	6903-1HKR	9	10846HKR	62	11650HKR	53
5208-1HKR	15,18	6160-1HKR	25	6904HKR	9	10846HKR	62	11654HKR	53
5209HKR	15,17	6161HKR	25	6904-1HKR	9	10848HKR	62	11661HKR	53
5209-1HKR	15,17	6161-1HKR	25	6905HKR	9	10849HKR	62	11666HKR	53
5210HKR	15	6163HKR	25	6905-1HKR	9	10852HKR	62	11701HKR	58
5210-1HKR	15	6201HKR	16	6906HKR	9	10860HKR	62	11702HKR	58
5210HKR	17	6201-1HKR	16	6906-1HKR	9	10861HKR	62	11730HKR	58
5210-1HKR	17	6203HKR	16	6907HKR	9,10	10863HKR	62	11742HKR	58
5215HKR	15,18,24,26	6203-1HKR	16	6907-1HKR	9,10	10871HKR	62	11752HKR	58
5215-1HKR	15,18,24,26	6205HKR	17	6909HKR	9	10872HKR	62	11760HKR	58
5303HKR	33	6205-1HKR	17	6909-1HKR	9	10873HKR	62	11762HKR	58
5303-1HKR	33	6208HKR	25	6910HKR	10	10877HKR	62	11764HKR	58
5320HKR	33	6208-1HKR	25	6910-1HKR	10	10878HKR	62	11770HKR	58
5320-1HKR	33	6209HKR	16,25	6911HKR	9,10	10882HKR	62	11808HKR	54
5322HKR	33	6209-1HKR	16,25	6911-1HKR	9,10	10883HKR	62	11809HKR	54
5481HKR	33	6210HKR	16,25	6912HKR	9,10	10886HKR	62	11810HKR	54
5481-1HKR	33	6210-1HKR	16,25	6912-1HKR	9,10	10887HKR	62	11822HKR	54
5483HKR	35	6211HKR	16	6913HKR	9	10891HKR	62	11828HKR	54
5484HKR	35	6211-1HKR	16	6913-1HKR	9	10912HKR	60	11829HKR	54
5602HKR	15,17,18	6222HKR	16,17,25	6914HKR	9	10917HKR	60	11831HKR	54
5602-2HKR	15,17,18	6222-1HKR	16,17	6914-1HKR	9	10918HKR	60	11832HKR	54
5707HKR	15,18,21	6223HKR	25	6915HKR	9	10922HKR	60	11833HKR	54
5707-1HKR	15,18,21	6223-1HKR	25	6915-1HKR	9	10925HKR	60	11834HKR	54
5803HKR	21	6224HKR	25	6916HKR	9,10	10926HKR	60	11841HKR	54
5803-1HKR	21	6224-1HKR	25	6916-1HKR	9,10	10927HKR	60	11851HKR	54
5901HKR	8	6225HKR	16,25	6920HKR	9	10928HKR	60	11857HKR	54
5901-1HKR	8	6225-1HKR	16	6920-1HKR	9	10961HKR	60	11858HKR	54
5902HKR	8	6226HKR	25	6921HKR	9	10979HKR	61	11859HKR	54
5902-1HKR	8	6226-1HKR	25	6921-1HKR	9	10980HKR	61	11863HKR	54
5903HKR	8	6227HKR	16,17,25	7103HKR	13	10981HKR	57	11866HKR	54
5903-1HKR	8	6227-1HKR	16,17	7103-1HKR	13	10983HKR	57	11870HKR	54
5905HKR	8	6228HKR	25	7104HKR	13	10984HKR	57	11871HKR	54
5905-1HKR	8	6228-1HKR	25	7104-1HKR	13	11024HKR	61	11872HKR	54
6000HKR	29	6229HKR	17	7105HKR	13	11025HKR	61	11873HKR	54
6001HKR	29	6229-1HKR	17	7105-1HKR	13	11026HKR	61	11887HKR	54
6003HKR	29	6230HKR	17	7901HKR	7	11030HKR	61	11888HKR	54
6050HKR	22	6230-1HKR	17	7901-1HKR	7	11032HKR	61	11890HKR	54
6050-1HKR	22	6231HKR	25	8900HKR	10	11035HKR	61	11891HKR	54
6102HKR	16	6231-1HKR	25	8900-1HKR	10	11036HKR	61	11892HKR	54
6102-1HKR	16	6233HKR	11,17	9401HKR	7	11037HKR	61	11893HKR	54
6110HKR	16	6233-1HKR	11,17	9401-1HKR	7	11040HKR	61	12101HKR	57
6110-1HKR	16	6375HKR	33	9402HKR	7	11045HKR	61	12102HKR	57
6111HKR	16	6375-1HKR	33	9402-1HKR	7	11046HKR	61	12103HKR	57
6111-1HKR	16	6601HKR	16	9403HKR	7	11125HKR	61	12104HKR	57
6113HKR	16	6601-1HKR	16	9403-1HKR	7	11130HKR	61	12105HKR	57
6113-1HKR	16	6802HKR	25	9810HKR	23	11136HKR	61	12200HKR	55
6114HKR	16	6802-1HKR	25	9810-1HKR	23	11138HKR	61	12210HKR	55
6114-1HKR	16	6808HKR	22	9814HKR	22	11139HKR	61	12220HKR	55
6115HKR	16	6808-1HKR	22	9820HKR	21	11143HKR	61	12230HKR	55
6115-1HKR	16	6809HKR	21	9820-1HKR	21	11147HKR	61	12240HKR	55
6116HKR	16	6809-1HKR	21	9825HKR	21,23	11148HKR	61	12250HKR	55
6116-1HKR	16	6811HKR	21	9825-1HKR	21,23	11190HKR	61	12260HKR	55
6119HKR	16	6811-1HKR	21	9826HKR	22	11230HKR	60	12270HKR	55
6119-1HKR	16	6823HKR	21,22	9826-1HKR	22	11235HKR	60	12280HKR	55
6120HKR	16	6823-1HKR	21,22	9828HKR	21	11330HKR	60	12285HKR	55
6120-1HKR	16	6824HKR	25	9828-1HKR	21	11331HKR	60	12310HKR	55
6124HKR	16	6824-1HKR	25	9829HKR	21	11335HKR	60	12311HKR	55

STREET R & HE DEBS
CAMARO/ FIREBIRD LSI HEADERS & YPIPE
M ETIT N HE DEBS
MUSTANG GT EXHAUST SYSTEM
SU ER M ETIT N HE DEBS
R E HE DEBS
M ETIT N & SU ER M E H LIST KITS
DIESEL E H LIST S STEMS
TB K S STEMS
MUFFLERS
E H LIST T I S
M NENTS & ESS RIES
HE DER & ULE T R G SKETS
F TN TES
PHOTO GALLERY
RT I CE INDE
W RR NT



Part #	Pg.	Part #	Pg.	Part #	Pg.	Part #	Pg.
12320HKR	55	16500HKR	38	21007HKR	47	22002HKR	51
12325HKR	56	16520HKR	38	21008HKR	47	22005HKR	51
12330HKR	55	16521HKR	38	21021HKR	50	22006HKR	51
12331HKR	56	16522HKR	38	21037HKR	49	22010HKR	51
12333HKR	56	16523HKR	38	21046HKR	46,50,53	22011HKR	51
12336HKR	56	16524HKR	38	21063HKR	50	22028HKR	51
12340HKR	55	16526HKR	38	21104HKR	47	22032HKR	51
12341HKR	56	16527HKR	38	21105HKR	47	22033HKR	51
12342HKR	56	16528HKR	38	21106HKR	47	22200HKR	51
12350HKR	56	16532HKR	38	21107HKR	47	22201HKR	51
12351HKR	56	16533HKR	38	21109HKR	47	22202HKR	51
12352HKR	56	16541HKR	38	21380HKR	56	22203HKR	51
12353HKR	56	16551HKR	37	21390HKR	56	22204HKR	51
12358HKR	56	16552HKR	37	21397HKR	56	22205HKR	51
12360HKR	55	16561HKR	37	21401HKR	52	22206HKR	51
12361HKR	56	16562HKR	37	21416HKR	52	22207HKR	51
12370HKR	56	16564HKR	37	21417HKR	52	22208HKR	51
12372HKR	56	16565HKR	37	21430HKR	52	22209HKR	51
12380HKR	55	16567HKR	37	21431HKR	52	22303HKR	51
12385HKR	55	16619HKR	38	21433HKR	52	22304HKR	51
12390HKR	56	16621HKR	38	21500HKR	42	31015HKR	49
12396HKR	56	16622HKR	38	21501HKR	42	31407HKR	52
12399HKR	56	16623HKR	38	21502HKR	42	31417HKR	52
12520HKR	56	16624HKR	38	21503HKR	42,43	31503HKR	52
12521HKR	56	16626HKR	38	21504HKR	42,43	31522HKR	59
12525HKR	56	16652HKR	37	21505HKR	42	31530HKR	59
12530HKR	56	16661HKR	37	21506HKR	42	32540HKR	56
12532HKR	56	16665HKR	37	21507HKR	42	32541HKR	56
12536HKR	56	16684HKR	4,11,17,41	21508HKR	42	32550HKR	56
12538HKR	56	16720HKR	14	21509HKR	43	32551HKR	56
12540HKR	56	16723HKR	5,7,14	21510HKR	43	32560HKR	56
12542HKR	56	16723-1HKR	7,14	21512HKR	43	32561HKR	56
12550HKR	56	16723-2HKR	5,7,14	21513HKR	43	32570HKR	56
12551HKR	56	16761HKR	17	21516HKR	42	32571HKR	56
12552HKR	56	16761-1HKR	17	21518HKR	42	32580HKR	56
12553HKR	56	16762HKR	17	21521HKR	11,41,44	32590HKR	56
12558HKR	56	16764HKR	16	21523HKR	11,41,44	32597HKR	56
12560HKR	56	16765HKR	14	21530HKR	42	32598HKR	56
12570HKR	56	16767HKR	7	21599HKR	42	35600HKR	55
12572HKR	56	16784HKR	4,41	21600HKR	45	41160HKR	57
12574HKR	56	16785HKR	20	21601HKR	45	41521HKR	61
12580HKR	56	16786HKR	20	21602HKR	45	50735HKR	30
12582HKR	56	16803HKR	57	21603HKR	45,46	50735-1HKR	30
12590HKR	56	16810HKR	41	21604HKR	45,46	50735-3HKR	30
12592HKR	56	16811HKR	41	21605HKR	45	65284HKR	30
12594HKR	56	16820HKR	41	21606HKR	45	76936HKR	30
12596HKR	56	16822HKR	41	21607HKR	45	84393HKR	31
12597HKR	56	16823HKR	41	21608HKR	45	84394HKR	31
12598HKR	56	16825HKR	41	21609HKR	45	110351HKR	61
12599HKR	56	16827HKR	41	21611HKR	45	110401HKR	61
12601HKR	28	16837HKR	41	21612HKR	45	20D04BERL	63
12603HKR	28	16862HKR	40	21613HKR	45	29D03A1ERL	63
12606HKR	28	16863HKR	40,41	21614HKR	45	29D03A2ERL	63
12608HKR	28	16864HKR	40,41	21630HKR	45	29D03BERL	63
12609HKR	28	16870HKR	40,41	21699HKR	45	29D03B1ERL	63
12610HKR	28	16872HKR	40,41	21700HKR	43	29D03B2ERL	63
12611HKR	28	16874HKR	40,41	21701HKR	43	29D03B3ERL	63
12630HKR	28	16922HKR	37	21702HKR	43	29D03B4ERL	63
12630HKR	28	16940-2HKR	39	21703HKR	43	29D03B5ERL	63
12635HKR	28	16942-2HKR	39	21704HKR	43	29D03B6ERL	63
12651HKR	28	16944-2HKR	39	21710HKR	43	29D04AERL	63
12677HKR	28	16945-2HKR	39	21720HKR	43	29D04B1ERL	63
12678HKR	28	16946-2HKR	39	21721HKR	43	29D04B2ERL	63
12679HKR	28	16950-2HKR	39	21722HKR	43	29D0EAERL	63
14701HKR	59	16952-2HKR	39	21725HKR	43	29D10ZERL	63
14703HKR	59	16954-2HKR	39	21726HKR	41	29D10Z1ERL	63
14704HKR	59	16955-2HKR	39	21729HKR	43	29D15ZERL	63
14705HKR	59	16956-2HKR	39	21760HKR	43	29D15Z1ERL	63
14730HKR	59	18517HKR	64	21800HKR	45,46	29D20ZERL	63
14742HKR	59	18523HKR	64	21801HKR	45	29D20Z1ERL	63
14743HKR	59	18615HKR	64	21802HKR	45	29DA3BERL	63
14752HKR	59	18617HKR	64	21803HKR	45	29DB3BERL	63
14760HKR	59	18623HKR	64	21804HKR	45	29DC3BERL	63
14762HKR	59	21002HKR	50	21810HKR	45	29DD3BERL	63
14770HKR	59	21003HKR	50	21902HKR	48	29DE3BERL	63
15450HKR	55	21004HKR	47	21903HKR	48	29D04A1ERL	63
15500HKR	55	21005HKR	47	22000HKR	51	29D04A2ERL	63
15700HKR	55	21006HKR	47	22001HKR	51		

- TRUCK F RCE HEADERS
- CAMAR / FREEDOM LSI HEADERS & Y-PIPE
- C MPETTI N HEADERS
- MUSTANG GT EXHAUST SYSTEM
- SUPER C MPETTI N HEADERS
- RACE HEADERS
- C MPETTI N & SUPER C MP EXHAUST KITS
- DIESEL EXHAUST SYSTEMS
- CATERPILAR SYSTEMS
- MUFFLERS
- EXHAUST TIPS
- C MP NETS & ACCESS RIES
- HEADER & C LLECT R GASKETS
- F TM TES
- PI T GALLERY
- PART # T PAGE INDEX
- WARRANTY



HOLLEY PERFORMANCE PRODUCTS LIMITED WARRANTY

All Holley Performance Products Limited Warranties are extended to the original consumer only. This Limited Warranty is not assignable or otherwise transferable. There are no warranties that extend beyond those stated herein. Holley Performance Products offers no other warranties expressed or implied beyond this Limited Warranty.

In the event of an alleged defect in material or workmanship, Holley Performance Products' responsibility is strictly limited to repair or replace the defective product. Holley has no other obligation expressed or implied. Final warranty determination will be in the sole discretion of Holley Performance Products. Holley shall not be responsible for; (a) actual or alleged labor, transportation, or other incidental charges; or (b) actual or alleged consequential or other damages incurred by use of any product of Holley Performance Products.

To initiate the warranty process, the consumer must return the alleged defective product to the place of purchase with a dated receipt and completed applicable warranty claim tag. Warranty claims will be rejected if the date of purchase cannot be established by the consumer. Do not send products directly to Holley Performance Products. Holley Performance Products assumes no responsibility for products sent directly to Holley Performance Products.

This Limited Warranty sets forth specific legal rights. The consumer may have other rights as a result of variations in state laws or provincial laws. This Limited Warranty supersedes all prior warranty statements.

HOLLEY/FLOWTECH/HOOKER/NOS/WEIAND – NEW PRODUCT

Holley Performance Products warrants its new Holley, Flowtech, Hooker, NOS, and Weiand products to be free from defects in material and workmanship for a period of 90 days from date of purchase.

Holley Performance Products Limited Warranty specifically does not apply to products, which have been (a) modified or altered in any way; (b) subjected to adverse conditions, such as misuse, neglect, accident, improper installation or adjustment, dirt or other contaminants, water, corrosion, or faulty repair; or (c) used in other than those applications recommended by Holley Performance Products. Holley Performance Products also does not warrant, and disclaims all liability for products used in racing activities and/or applications other than those specifically recommended in the current brand catalog.

Holley limits the warranty on Metallic Ceramic Coatings to be free from defects in material and workmanship for a period of 90 days from the date of purchase. This limited coating warranty does not apply to any products which have been subjected to adverse conditions, such as high heat encountered during engine break-in or if used during any racing activity.

MARINE PRODUCTS

Holley Performance Products warrants its new marine products to be free from defects in material and workmanship for a period of 90 days from date of purchase. For the safety and protection of persons and property, all United States Coast Guard and other marine product safety installation and use requirements and recommendations must be carefully studied and applied. The above recommendations include, but are not limited to the recommendation that the installation, adjustment, and repair of Holley carburetors or other marine products must be performed only by a trained mechanic having adequate marine fuel system experience, and in strict compliance with the applicable Holley installation, maintenance, and other instructions. Failure to follow such requirements and recommendations will void this Holley Marine Limited Warranty, and Holley disclaims any responsibility and/or liability for accidents resulting from such failure.

Holley Performance Products Limited Warranty specifically does not apply to products, which have been (a) modified or altered in any way; (b) subjected to adverse conditions, such as misuse, neglect, accident, improper installation or adjustment, dirt or other contaminants, water, corrosion, or faulty repair; or (c) used in other than those applications recommended by Holley Performance Products. Holley Performance Products also does not warrant, and disclaims all liability for products used in racing activities and/or applications other than those specifically recommended in the current brand catalog.

STREET FORCE HEADERS

CAMARO/ FIBERED LSI HEADERS & YPIPE

COMPETITION HEADERS

MUSTANG GT EXHAUST SYSTEM

SUPER COMPETITION HEADERS

RACE HEADERS

COMPETITION & SUPER COMP EXHAUST KITS

DIESEL EXHAUST SYSTEMS

CATBACK SYSTEMS

MUFFLERS

EXHAUST TIPS

COMPONENTS & ACCESSORIES

HEADER & COLLECTOR GASKETS

PHOTO GALLERY

FOOTNOTES

PART # TO PAGE INDEX

WARRANTY

NEW!

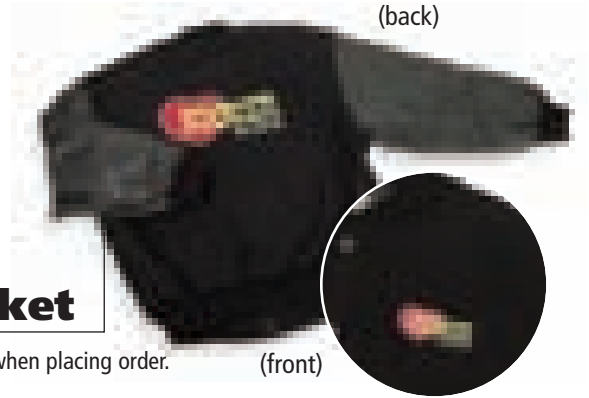

Hooker® Letterman Jacket

P/N 10147- HKR Add S,M,L,XL or XXL to part number when placing order.
- Hooker color logo embroidered on front and back.

Hooker® Retro Shirt

Add S,M,L,XL,XXL or XXXL to part number when placing order.

P/N 10148- HKR

Features a classic image of a 55 Chevy 2 door post assuming the 1960's gasser pose clapped out with a solid axle, American® Torque Thrust rollers, and M H Racemasters® on the backside. Powered by a nasty rat motor sporting 2 Holley 750 Double Pumpers™ perched atop a Weiland Tunnel Ram. To wake up the neighbors, it's running Hooker Super Competition equal length fenderwell headers, snaking through the fiberglass flip front end. Up front, you have the classic logo that proudly proclaims how much you love your Hookers.

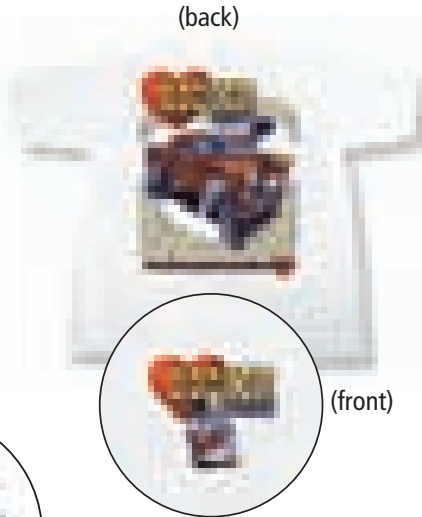

Hooker® Polo Shirt

P/N 10143- HKR
Add S,M,L,XL or XXL to part number when placing order.
- Hooker color logo embroidered on front



Hooker® Hooded Sweatshirt

P/N 10144- HKR
Add S,M,L,XL or XXL to part number when placing order.
- Hooker color logo on front & back with flames on the sleeves.



Hooker® Metal Sign

P/N 10145HKR 12" x 19" Metal sign with embossed Hooker logo

Hooker® T-shirt - Hooker color logo on front & back

- P/N 10232HKR (black shirt) - S
- P/N 10233HKR (black shirt) - M
- P/N 10234HKR (black shirt) - L
- P/N 10235HKR (black shirt) - XL
- P/N 10236HKR (black shirt) - XXL
- P/N 10132HKR (white shirt) - S
- P/N 10133HKR (white shirt) - M
- P/N 10134HKR (white shirt) - L
- P/N 10135HKR (white shirt) - XL
- P/N 10136HKR (white shirt) - XXL



Hooker® Caps

P/N 10212HKR
One size fits all -
Black with Hooker logo embroidered on front
P/N 10213HKR
One size fits all -
Khaki with Hooker logo embroidered on front



NEW & HOT PRODUCTS



**Super Competition
LS-1 Engine Swap
Headers for 67-69
Camaro/Firebird
& 66-72 Chevelle/
El Camino and all
GM A Bodies**

Pages 5,7,10,14 & 18

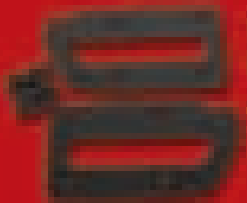

**LS-1
Engine Swap
Adapter Plates**

Page 28



**Super
Competition
5.7L Hemi E/B Body
Full Length Headers**

Pages 15,17,24 & 26



**Retro Hooker
t-shirt & more
Hooker Header
merchandising**

Inside Back Cover

HOOKER
HEADERS
A Holley Performance Brand

1801 Russellville Road, P.O. Box 10360
Bowling Green, KY 42102-7360

DEALER LINE: 1-800-HOLLEY1
TECH LINE: 270-781-9741
WEBSITE: www.ilovemyhookerheaders.com

P/N L30883
© Holley Performance Products, Inc. 2006
Printed in U.S.A.

