

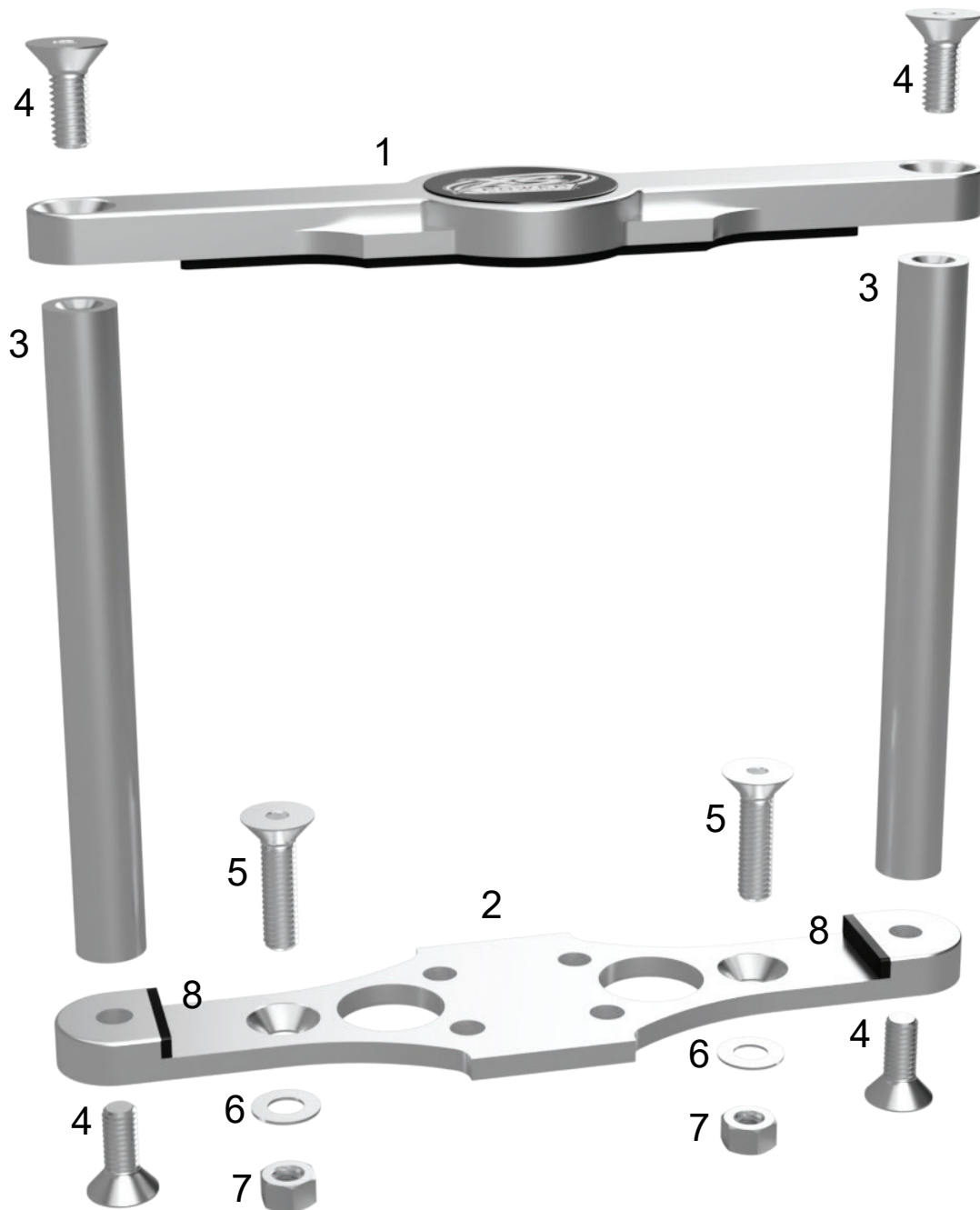

HOLD DOWN PARTS BREAKDOWN

For Models: HD-5100



- | | |
|----------------------|------------------------|
| 1.) Top Plate | 5.) Long Screws [2] |
| 2.) Bottom Plate | 6.) Washers [2] |
| 3.) Spindles [2] | 7.) Nuts [2] |
| 4.) Short Screws [4] | 8.) Rubber Bumpers [2] |